



**OWNER'S MANUAL
MANUEL DU PROPRIÉTAIRE
BEDIENUNGSANLEITUNG**

YZ85

YZ85(W)

YZ85W1

YZ85LW(W)

5PA-28199-85



PRINTED ON RECYCLED PAPER
IMPRIMÉ SUR PAPIER RECYCLÉ
AUF RECYCLINGPAPIER GEDRUCKT

PRINTED IN JAPAN
2006.04-1.4×1 CR
(E,F,G)



OWNER'S MANUAL

YZ85

YZ85(W)

YZ85W1

YZ85LW(W)

5PA-28199-85-E0

Congratulations on your purchase of the Yamaha YZ85(W)/YZ85W1/YZ85LW(W). This model is the result of Yamaha's vast experience in the production of fine sporting, touring, and pacesetter racing machines. It represents the high degree of craftsmanship and reliability that have made Yamaha a leader in these fields.

This manual will give you an understanding of the operation, inspection, and basic maintenance of this motorcycle. If you have any questions concerning the operation or maintenance of your motorcycle, please consult a Yamaha dealer.

AN IMPORTANT SAFETY MESSAGE:

- READ THIS MANUAL COMPLETELY BEFORE OPERATING YOUR MOTORCYCLE. MAKE SURE YOU UNDERSTAND ALL INSTRUCTIONS.
- PAY CLOSE ATTENTION TO THE WARNING AND CAUTION LABELS ON THE MOTORCYCLE.
- NEVER OPERATE A MOTORCYCLE WITHOUT PROPER TRAINING OR INSTRUCTION.

AN IMPORTANT NOTE TO PARENTS:

This motorcycle is not a toy. Before you let your child ride this motorcycle, you should understand the instructions and warnings in this Owner's Manual. Then be sure your child understands and will follow them. Children differ in skills, physical abilities, and judgment. Some children may not be able to operate a motorcycle safely. Parents should supervise their child's use of the motorcycle at all times. Parents should permit continued use only if they determine that the child has the ability to operate the motorcycle safely.

MOTORCYCLES ARE SINGLE TRACK VEHICLES. THEIR SAFE USE AND OPERATION ARE DEPENDENT UPON THE USE OF PROPER RIDING TECHNIQUES AS WELL AS THE EXPERTISE OF THE OPERATOR. EVERY OPERATOR SHOULD KNOW THE FOLLOWING REQUIREMENTS BEFORE RIDING THIS MOTORCYCLE.



HE OR SHE SHOULD:

- OBTAIN THOROUGH INSTRUCTIONS FROM A COMPETENT SOURCE ON ALL ASPECTS OF MOTORCYCLE OPERATION.
- OBSERVE THE WARNINGS AND MAINTENANCE REQUIREMENTS IN THE OWNER'S MANUAL.
- OBTAIN QUALIFIED TRAINING IN SAFE AND PROPER RIDING TECHNIQUES.
- OBTAIN PROFESSIONAL TECHNICAL SERVICE AS INDICATED BY THE OWNER'S MANUAL AND/OR WHEN MADE NECESSARY BY MECHANICAL CONDITIONS.

IMPORTANT MANUAL INFORMATION

EAU41090

Particularly important information is distinguished in this manual by the following notations:

	The Safety Alert Symbol means ATTENTION! BECOME ALERT! YOUR SAFETY IS INVOLVED!
	Failure to follow WARNING instructions could result in severe injury or death to the motorcycle operator, a bystander or a person inspecting or repairing the motorcycle.
CAUTION:	A CAUTION indicates special precautions that must be taken to avoid damage to the motorcycle.
NOTE:	A NOTE provides key information to make procedures easier or clearer.

NOTE:

- This manual should be considered a permanent part of this motorcycle and should remain with it even if the motorcycle is subsequently sold.
- Yamaha continually seeks advancements in product design and quality. Therefore, while this manual contains the most current product information available at the time of printing, there may be minor discrepancies between your motorcycle and this manual. If you have any questions concerning this manual, please consult your Yamaha dealer.

EWA10030



PLEASE READ THIS MANUAL CAREFULLY AND COMPLETELY BEFORE OPERATING THIS MOTORCYCLE.

IMPORTANT MANUAL INFORMATION

EWA14350

WARNING

THIS MOTORCYCLE IS DESIGNED AND MANUFACTURED FOR OFF-ROAD USE ONLY. IT IS ILLEGAL TO OPERATE THIS MOTORCYCLE ON ANY PUBLIC STREET, ROAD OR HIGHWAY. SUCH USE IS PROHIBITED BY LAW. THIS MOTORCYCLE COMPLIES WITH ALMOST ALL STATE OFF-HIGHWAY NOISE LEVEL AND SPARK ARRESTER LAWS AND REGULATIONS. PLEASE CHECK YOUR LOCAL RIDING LAWS AND REGULATIONS BEFORE OPERATING THIS MOTORCYCLE.

*Product and specifications are subject to change without notice.

IMPORTANT MANUAL INFORMATION

EAU10200

**YZ85(W)/YZ85W1/YZ85LW(W)
OWNER'S MANUAL
©2006 by Yamaha Motor Co., Ltd.
1st edition, March 2006
All rights reserved.
Any reprinting or unauthorized use
without the written permission of
Yamaha Motor Co., Ltd.
is expressly prohibited.
Printed in Japan.**

TABLE OF CONTENTS

SAFETY INFORMATION	1-1	OPERATION AND IMPORTANT	
Location of important labels	1-4	RIDING POINTS	5-1
DESCRIPTION	2-1	Starting and warming up a cold	
Left view	2-1	engine	5-1
Right view	2-2	Starting a warm engine	5-1
Controls and instruments	2-3	Shifting	5-2
INSTRUMENT AND CONTROL		Engine break-in	5-3
FUNCTIONS	3-1	Parking	5-4
Handlebar switch	3-1	PERIODIC MAINTENANCE AND	
Clutch lever	3-1	MINOR REPAIR	6-1
Shift pedal	3-1	Periodic maintenance and	
Brake lever	3-2	lubrication chart	6-2
Brake pedal	3-2	Checking the spark plug	6-8
Fuel tank cap	3-3	Transmission oil	6-9
Fuel	3-3	Coolant	6-10
Fuel tank breather hose	3-5	Cleaning the air filter element	6-12
Fuel cock	3-5	Adjusting the carburetor	6-14
Starter (choke) knob	3-6	Adjusting the throttle cable	
Kickstarter	3-6	free play	6-14
Seat	3-6	Tires	6-15
Adjusting the front fork	3-7	Spoke wheels	6-17
Front fork bleeding	3-8	Accessories and replacement	
Adjusting the shock absorber		parts	6-17
assembly	3-9	Adjusting the clutch lever	
Removable sidestand	3-12	free play	6-17
PRE-OPERATION CHECKS	4-1	Checking the front and rear brake	
Pre-operation check list	4-2	pads	6-18
		Checking the brake fluid level	6-19
		Changing the brake fluid	6-20
		Drive chain slack	6-20
		Cleaning and lubricating the	
		drive chain	6-21
		Checking and lubricating the	
		cables	6-22
		Checking and lubricating the	
		throttle grip and cable	6-22
		Checking and lubricating the	
		brake and shift pedals	6-23
		Checking and lubricating the	
		brake and clutch levers	6-23
		Lubricating the swingarm pivots ...	6-24
		Lubricating the rear suspension ...	6-24
		Checking the front fork	6-24
		Checking the steering	6-25
		Checking the wheel bearings	6-26
		Supporting the motorcycle	6-26
		Front wheel	6-27
		Rear wheel	6-27
		Troubleshooting	6-29
		Troubleshooting charts	6-30
		MOTORCYCLE CARE AND	
		STORAGE	7-1
		Care	7-1
		Storage	7-3
		SPECIFICATIONS	8-1
		CONSUMER INFORMATION	9-1
		Identification numbers	9-1

SAFETY INFORMATION

EAU41460

Safe riding

- Always make pre-operation checks. Careful checks may help prevent an accident.
- This motorcycle is designed for off-road use only, therefore, it is illegal to operate it on public streets, roads, or highways, even a dirt or gravel one. Off-road use on public lands may be illegal. Please check local regulations before riding.
- This motorcycle is designed to carry the operator only. No passengers.
- Many accidents involve inexperienced operators.
 - Make sure that the operator is qualified and that you only lend your motorcycle to other qualified operators.
 - Know your skills and limits. Staying within your limits may help you to avoid an accident.
- Many accidents have been caused by error of the motorcycle operator. A typical error made by the operator is veering wide on a turn due to EXCESSIVE SPEED or un-

dercornering (insufficient lean angle for the speed). Never travel faster than warranted by conditions.

- Ride cautiously in unfamiliar areas. You may encounter hidden obstacles that could cause an accident.
- The posture of the operator is important for proper control. The operator should keep both hands on the handlebar and both feet on the operator footrests during operation to maintain control of the motorcycle.
- Never ride under the influence of alcohol or other drugs.
- Be sure the transmission is in neutral before starting the engine.

Protective apparel

The majority of fatalities from motorcycle accidents are the result of head injuries. The use of a safety helmet is the single most critical factor in the prevention or reduction of head injuries.

- Always wear an approved helmet.

- Wear a face shield or goggles. Wind in your unprotected eyes could contribute to an impairment of vision that could delay seeing a hazard.
- The use of a jacket, heavy boots, trousers, gloves, etc., is effective in preventing or reducing abrasions or lacerations.
- Never wear loose-fitting clothes, otherwise they could catch on the control levers, footrests, or wheels and cause injury or an accident.
- Never touch the engine or exhaust system during or after operation. They become very hot and can cause burns. Always wear protective clothing that covers your legs, ankles, and feet.

Modifications

Modifications made to this motorcycle not approved by Yamaha, or the removal of original equipment, may render the motorcycle unsafe for use and may cause severe personal injury. Modifications may also make your motorcycle illegal to use.

Loading and accessories

Adding accessories to your motorcycle can adversely affect stability and handling if the weight distribution of the motorcycle is changed. To avoid the possibility of an accident, use extreme caution when adding accessories to your motorcycle. Use extra care when riding a motorcycle that has added accessories. Here are some general guidelines to follow if adding accessories to your motorcycle:

Loading

- Accessory weight should be kept as low and close to the motorcycle as possible. Make sure to distribute the weight as evenly as possible on both sides of the motorcycle to minimize imbalance or instability.
- Shifting weights can create a sudden imbalance. Make sure that accessories are securely attached to the motorcycle before riding. Check accessory mounts frequently.
- Never attach any large or heavy items to the handlebar, front fork, or front fender.

Accessories

Genuine Yamaha accessories have been specifically designed for use on this motorcycle. Since Yamaha cannot test all other accessories that may be available, you must personally be responsible for the proper selection, installation and use of non-Yamaha accessories. Use extreme caution when selecting and installing any accessories.

Keep these guidelines in mind for mounting accessories in addition to those provided under “Loading”.

- Never install accessories or that would impair the performance of your motorcycle. Carefully inspect the accessory before using it to make sure that it does not in any way reduce ground clearance or cornering clearance, limit suspension travel, steering travel or control operation.
- Accessories fitted to the handlebar or the front fork area can create instability due to improper weight distribution or aerodynamic changes. If accessories are added to the handlebar or

front fork area, they must be as lightweight as possible and should be kept to a minimum.

- Bulky or large accessories may seriously affect the stability of the motorcycle due to aerodynamic effects. Wind may attempt to lift the motorcycle, or the motorcycle may become unstable in cross winds.
- Certain accessories can displace the operator from his or her normal riding position. This improper position limits the freedom of movement of the operator and may limit control ability, therefore, such accessories are not recommended.
- Use caution when adding electrical accessories. If electrical accessories exceed the capacity of the motorcycle’s electrical system an electric failure could result, which could cause a dangerous loss of engine power.

SAFETY INFORMATION

1

Gasoline and exhaust gas

- GASOLINE IS HIGHLY FLAMMABLE:

- Be sure to always use a fresh mixture of oil and gasoline.
- Always turn the engine off when refueling.
- Take care not to spill any gasoline on the engine or exhaust pipe/muffler when refueling.
- Never refuel while smoking or in the vicinity of an open flame.
- Never start the engine or let it run for any length of time in a closed area. The exhaust fumes are poisonous and may cause loss of consciousness and death within a short time. Always operate your motorcycle in an area that has adequate ventilation.
- Always turn the engine off before leaving the motorcycle unattended. When parking the motorcycle, note the following:
 - The engine and exhaust pipe/muffler may be hot, therefore, park the motorcycle in a

place where pedestrians or children are not likely to touch these hot areas.

- Do not park the motorcycle on a slope or soft ground, otherwise it may fall over.
- Do not park the motorcycle near a flammable source (e.g., a kerosene heater, or near an open flame), otherwise it could catch fire.
- When transporting the motorcycle in another vehicle, make sure that it is kept upright and that the fuel cock is turned to “OFF”. If the motorcycle should lean over, gasoline may leak out of the carburetor or fuel tank.
- If you should swallow any gasoline, inhale a lot of gasoline vapor, or allow gasoline to get into your eyes, see your doctor immediately. If any gasoline spills on your skin or clothing, immediately wash the affected area with soap and water and change your clothes.

Location of important labels

Please read the following important labels carefully before operating this vehicle.

YZ85(W)/YZ85W1

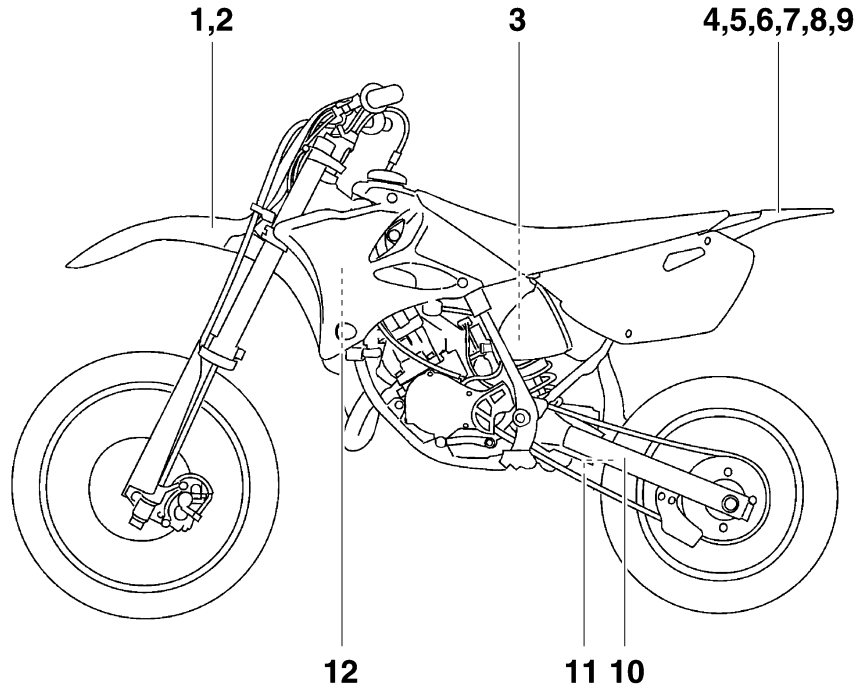

SAFETY INFORMATION

For Canada

1

1

CAUTION

Use premium unleaded gasoline/oil premix only.

3XJ-2415E-A0

2

ATTENTION

Utiliser de préférence un mélange huile/super sans plomb.

3XJ-2415E-B0

3

 WARNING

This unit contains high pressure nitrogen gas. Mishandling can cause explosion.

- Read owner's manual for instructions.
- Do not incinerate, puncture or open.

 AVERTISSEMENT

Cette unité contient de l'azote à haute pression. Une mauvaise manipulation peut entraîner d'explosion.

- Voir le manuel d'utilisateur pour les instructions.
- Ne pas brûler ni perforer ni ouvrir.

4AA-22259-60

4

 WARNING

Riding as a passenger can cause the vehicle to go out of control.

Loss of control can cause a collision or rollover, which can result in severe injury or death.

NEVER ride as a passenger.

3XJ-2151H-A1

5

 AVERTISSEMENT

Un passager pourrait causer une perte de contrôle du véhicule.

Une perte de contrôle peut provoquer une collision ou un renversement, résultant en des blessures sérieuses, voire mortelles.

AUCUN passager permis.

3XJ-2151H-B1

6

 **WARNING**

- BEFORE YOU OPERATE THIS VEHICLE, READ THE OWNER'S MANUAL AND ALL LABELS.
- NEVER CARRY A PASSENGER. You increase your risk of losing control if you carry a passenger.
- NEVER OPERATE THIS VEHICLE ON PUBLIC ROADS. You can collide with another vehicle if you operate this vehicle on a public road.
- ALWAYS WEAR AN APPROVED MOTORCYCLE HELMET, eye protection, and protective clothing.
- EXPERIENCED RIDER ONLY.

5PA-2118K-00

7

 **AVERTISSEMENT**

- LIRE LE MANUEL DU PROPRIETAIRE ANSI QUE TOUTES LES ETIQUETTES AVANT D'UTILISER CE VEHICULE.
- NE JAMAIS TRANSPORTER DE PASSAGER. La conduite avec passager augmente les risques de perte de contrôle.
- NE JAMAIS ROULER SUR DES CHEMINS PUBLICS. Vous pourriez entrer en collision avec un autre véhicule.
- TOUJOURS PORTER UN CASQUE DE MOTOCYCLISTE APPROUVE, des lunettes et des vêtements de protection.
- EXCLUSIVEMENT POUR L'USAGE D'UN CONDUCTEUR EXPERIMENTE.

5PA-2118K-10

10

TIRE INFOMATION

Cold tire normal pressure should be set as follows.

FRONT : 100kPa, {1.00kgf/cm²}, 15psi
REAR : 100kPa, {1.00kgf/cm²}, 15psi

3RV-21668-A0

11

INFORMATION SUR LES PNEUS

La pression des pneus à froid doit normalement être réglée comme suit.

AVANT : 100kPa, {1.00kgf/cm²}, 15psi
ARRIERE : 100kPa, {1.00kgf/cm²}, 15psi

3RV-21668-B0

SAFETY INFORMATION

For Europe

1

3



9



8





- Before you operate this vehicle, read the owner's manual.
- Prima di usare il veicolo, leggete il manuale di istruzioni.
- Lire le manuel du propriétaire avant d'utiliser ce véhicule.
- Lesen Sie die Bedienungsanleitung bevor Sie dieses Fahrzeug fahren.
- Antes de conducir este vehículo, lea el Manual del Propietario.

5PA-21568-00

10

TIRE INFORMATION

Cold tire normal pressure should be set as follows.

FRONT : 100kPa, {1.00kgf/cm²}, 15psi

REAR : 100kPa, {1.00kgf/cm²}, 15psi

3RV-21668-A0

12

CE

YAMAHA MOTOR CO., LTD.
SHIZUOKA JAPAN

YAMAHA 4GB-2155A-00

For Oceania and South Africa

3





10

TIRE INFORMATION	
Cold tire normal pressure should be set as follows.	
FRONT:	100kPa, {1.00kgf/cm ² }, 15psi
REAR :	100kPa, {1.00kgf/cm ² }, 15psi
3RV-21668-A0	

1

8

	
<ul style="list-style-type: none">• Before you operate this vehicle, read the owner's manual.• Prima di usare il veicolo, leggete il manuale di istruzioni.• Lire le manuel du propriétaire avant d'utiliser ce véhicule.• Lesen Sie die Bedienungsanleitung bevor Sie dieses Fahrzeug fahren.• Antes de conducir este vehículo, lea el Manual del Propietario.	
5PA-21568-00	

SAFETY INFORMATION

YZ85LW(W)

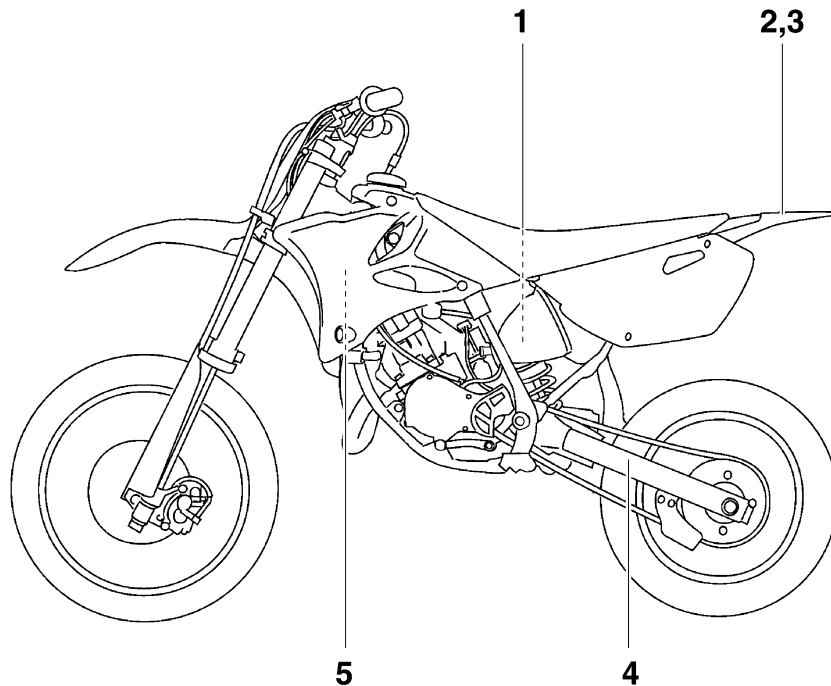

1



For Europe



2

- Before you operate this vehicle, read the owner's manual.
- Prima di usare il veicolo, leggete il manuale di istruzioni.
- Lire le manuel du propriétaire avant d'utiliser ce véhicule.
- Lesen Sie die Bedienungsanleitung bevor Sie dieses Fahrzeug fahren.
- Antes de conducir este vehículo, lea el Manual del Propietario.

5PA-21568-00

4

TIRE INFORMATION

Cold tire normal pressure should be set as follows:
FRONT : 100kPa, {1.00kgf/cm²}, 15psi
REAR : 100kPa, {1.00kgf/cm²}, 15psi

3RV-21668-A0

5



YAMAHA MOTOR CO., LTD.
SHIZUOKA JAPAN

YAMAHA 4GB-2155A-00

SAFETY INFORMATION

For Oceania

1

1





4

TIRE INFORMATION
Cold tire normal pressure should be set as follows.
FRONT : 100kPa, {1.00kgf/cm ² }, 15psi
REAR : 100kPa, {1.00kgf/cm ² }, 15psi

3RV-21668-A0

2

<ul style="list-style-type: none">• Before you operate this vehicle, read the owner's manual.• Prima di usare il veicolo, leggete il manuale di istruzioni.• Lire le manuel du propriétaire avant d'utiliser ce véhicule.• Lesen Sie die Bedienungsanleitung bevor Sie dieses Fahrzeug fahren.• Antes de conducir este vehículo, lea el Manual del Propietario.



5PA-21568-00

Left view

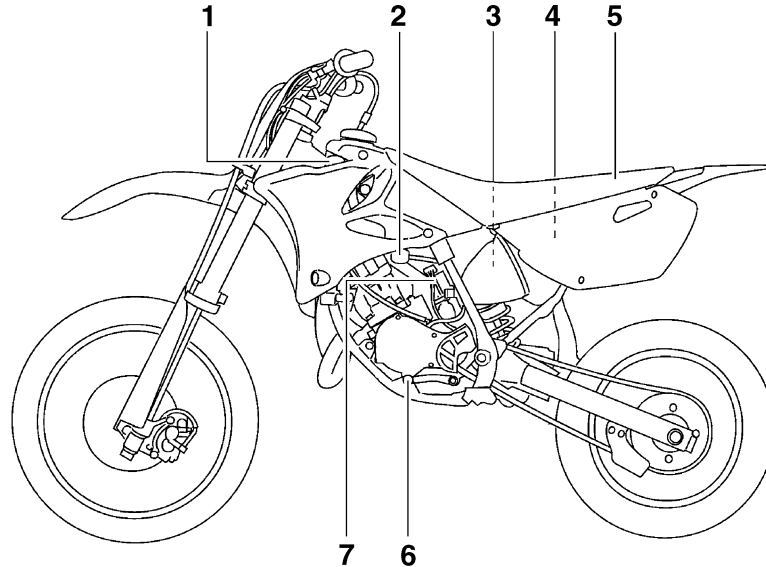

1. Radiator cap (page 6-10)
2. Fuel cock (page 3-5)
3. Shock absorber assembly spring preload adjusting nut (page 3-9)
4. Air filter element (page 6-12)
5. Seat (page 3-6)
6. Shift pedal (page 3-1)
7. Starter (choke) knob (page 3-6)

DESCRIPTION

EAU10420

Right view

2

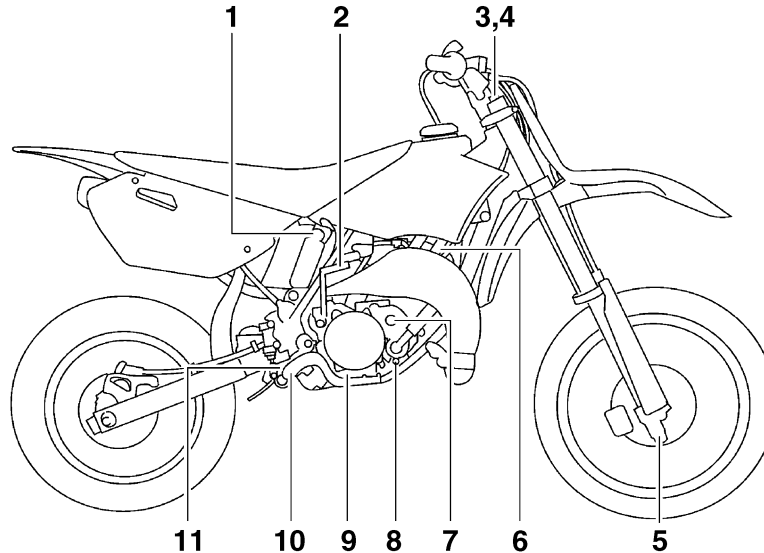

1. Shock absorber assembly compression damping force adjusting screw (page 3-9)
2. Kickstarter (page 3-6)
3. Front fork rebound damping force adjusting screw (page 3-7)
4. Bleed screw (page 3-8)
5. Front fork compression damping force adjusting screw (page 3-7)
6. Spark plug cap (page 6-8)
7. Oil filler cap (page 6-9)
8. Coolant drain bolt (page 6-11)
9. Transmission oil drain bolt (page 6-9)
10. Brake pedal (page 3-2)
11. Shock absorber assembly rebound damping force adjusting screw (page 3-9)

Controls and instruments

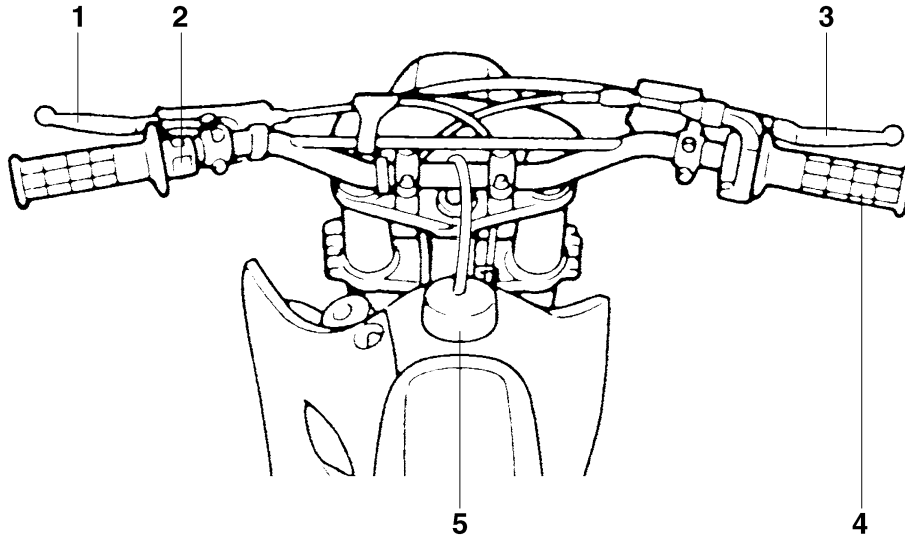

- 1. Clutch lever (page 3-1)
- 2. Left handlebar switch (page 3-1)
- 3. Brake lever (page 3-2)
- 4. Throttle grip (page 6-14)
- 5. Fuel tank cap (page 3-3)

INSTRUMENT AND CONTROL FUNCTIONS

Handlebar switch

EAU40660

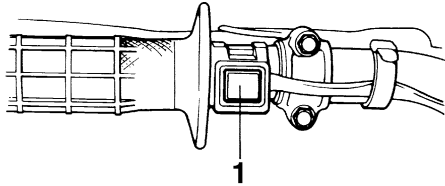

1. Engine stop button “ENGINE STOP”

“ENGINE STOP” button

EAU12670

Hold this button pushed until the engine stops in case of an emergency, such as when the vehicle overturns or when the throttle cable is stuck.

Clutch lever

EAU12850

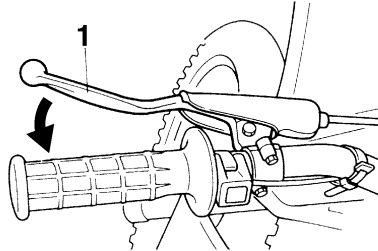

1. Clutch lever

The clutch lever is located at the left handlebar grip. To disengage the clutch, pull the lever toward the handlebar grip. To engage the clutch, release the lever. The lever should be pulled rapidly and released slowly for smooth clutch operation.

Shift pedal

EAU12870

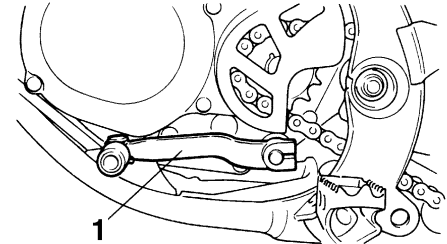

1. Shift pedal

The shift pedal is located on the left side of the engine and is used in combination with the clutch lever when shifting the gears of the 6-speed constant-mesh transmission equipped on this motorcycle.

EAU41261

Brake lever

The brake lever is located at the right handlebar grip. To apply the front brake, pull the lever toward the handlebar grip.

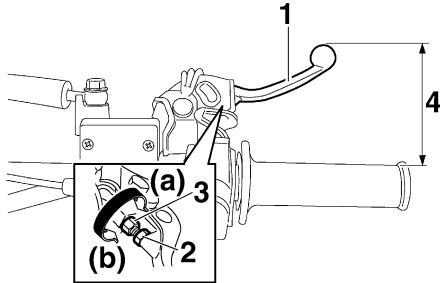

1. Brake lever
2. Locknut
3. Adjusting bolt
4. Distance between brake lever and handlebar grip

The brake lever is equipped with a position adjusting bolt. Adjust the distance between the brake lever and the handlebar grip as follows.

1. Loosen the locknut.

2. While holding the lever pushed away from the handlebar grip, turn the adjusting bolt in direction (a) to increase the distance, and in direction (b) to decrease it.

Distance between the brake lever and the handlebar grip:

- Minimum (shortest):
76 mm (2.99 in)
- Standard:
95 mm (3.74 in)
- Maximum (longest):
97 mm (3.82 in)

3. Tighten the locknut.

EAU12941

Brake pedal

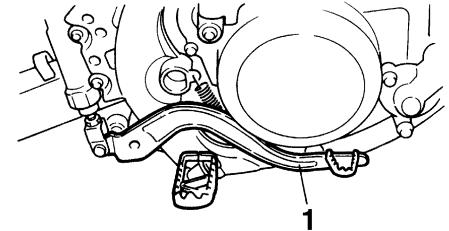

1. Brake pedal

The brake pedal is on the right side of the motorcycle. To apply the rear brake, press down on the brake pedal.

INSTRUMENT AND CONTROL FUNCTIONS

Fuel tank cap

EAU13180

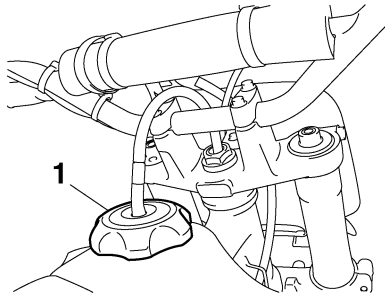

1. Fuel tank cap

To remove the fuel tank cap, turn it counterclockwise, and then pull it off. To install the fuel tank cap, insert it into the tank opening, and then turn it clockwise.

EWA11090



Make sure that the fuel tank cap is properly closed before riding.

Fuel

EAU41831

This motorcycle has been designed to use a premixed fuel of gasoline and 2-stroke engine oil. Always mix the gasoline and oil in a clean container before filling the fuel tank.

ECA15601

CAUTION:

Always use fresh gasoline, and fill the fuel tank with a fresh mix just before riding. Do not use premixed fuel that is more than a few hours old.

Mixing gasoline and 2-stroke engine oil

Pour 2-stroke engine oil into a clean container, and then add gasoline. To mix the fuel thoroughly, shake the container from side to side.

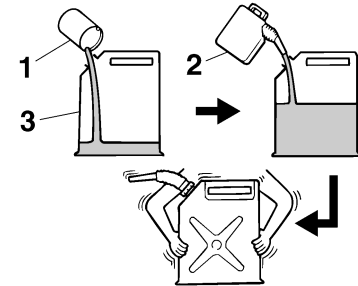

1. 2-stroke engine oil
2. Gasoline
3. Container

Recommended fuel:

Premium unleaded gasoline only

Recommended 2-stroke engine oil:

See page 8-1.

Fuel tank capacity:

5.0 L (1.32 US gal) (1.10 Imp.gal)

Mixing ratios (gasoline to oil):

Break-in period: 15:1

After break-in: 30:1

ECA15590

CAUTION:

Use only unleaded gasoline. The use of leaded gasoline will cause severe damage to internal engine parts, such as the piston rings as well as to the exhaust system.

INSTRUMENT AND CONTROL FUNCTIONS

ECA10070

Your Yamaha engine has been designed to use premium unleaded gasoline with a pump octane number $[(R+M)/2]$ of 91 or higher, or a research octane number of 95 or higher. If knocking (or pinging) occurs, use a gasoline of a different brand. If the recommended 2-stroke engine oil is not available, use an equivalent oil.

ECA15551

CAUTION:

Never mix two brands of 2-stroke engine oil in the same batch. Always use the same type of oil to ensure maximum engine performance. Should it be necessary to use a different oil brand, be sure to drain the fuel tank and the carburetor float chamber of the old premixed fuel prior to filling with the new type.

Filling the fuel tank

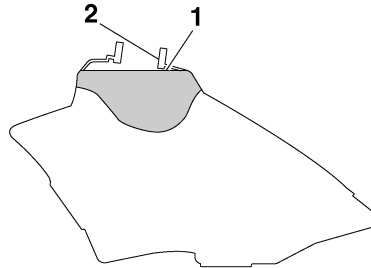

1. Fuel level
2. Fuel tank filler tube

Make sure that there is sufficient fuel in the tank. Fill the fuel tank to the bottom of the filler tube as shown.

EWA10880

! WARNING

- Do not overfill the fuel tank, otherwise it may overflow when the fuel warms up and expands.
- Avoid spilling fuel on the hot engine.

CAUTION:

Immediately wipe off spilled fuel with a clean, dry, soft cloth, since fuel may deteriorate painted surfaces or plastic parts.

INSTRUMENT AND CONTROL FUNCTIONS

Fuel tank breather hose

EAU41360

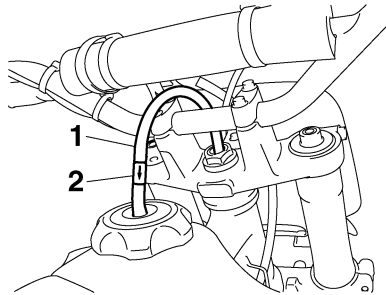

1. Fuel tank breather hose
2. One-way valve

Before operating the motorcycle:

- Check the fuel tank breather hose connection.
- Check the fuel tank breather hose for cracks or damage, and replace it if damaged.
- Make sure that the end of the fuel tank breather hose is not blocked, and clean it if necessary.

NOTE:

If the fuel tank breather hose falls out, reinstall it on the fuel tank cap with the arrow mark on the one-way valve pointed downward as shown.

Fuel cock

EAU41280

The fuel cock supplies fuel from the tank to the carburetor while filtering it also.

The fuel cock has two positions:

OFF

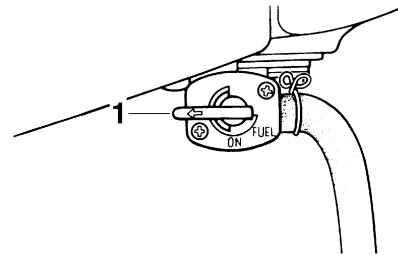

1. Arrow mark positioned over "OFF"

With the lever in this position, fuel will not flow. Always return the lever to this position when the engine is not running.

ON

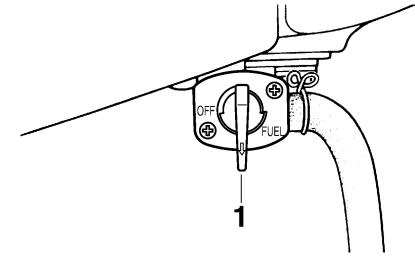

1. Arrow mark positioned over "ON"

With the lever in this position, fuel flows to the carburetor. Normal riding is done with the lever in this position.

Starter (choke) knob

EAU13640

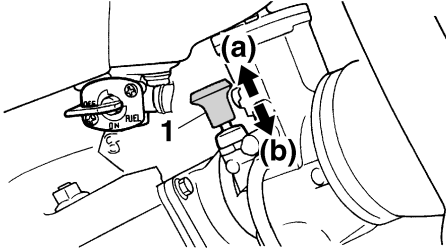

1. Starter (choke) knob

Starting a cold engine requires a richer air-fuel mixture, which is supplied by the starter (choke). Move the knob in direction (a) to turn on the starter (choke). Move the knob in direction (b) to turn off the starter (choke).

Kickstarter

EAU13650

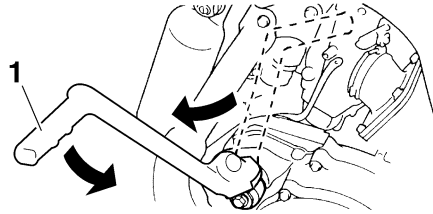

1. Kickstarter lever

To start the engine, fold out the kickstarter lever, move it down lightly with your foot until the gears engage, and then push it down smoothly but forcefully. This model is equipped with a primary kickstarter, allowing the engine to be started in any gear if the clutch is disengaged. However, shifting the transmission into the neutral position before starting is recommended.

Seat

EAU13960

To remove the seat

Remove the bolts, and then pull the seat off.

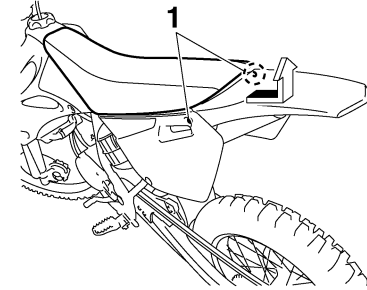

1. Bolt

To install the seat

1. Insert the projections on the front of the seat into the seat holders as shown.

INSTRUMENT AND CONTROL FUNCTIONS

3

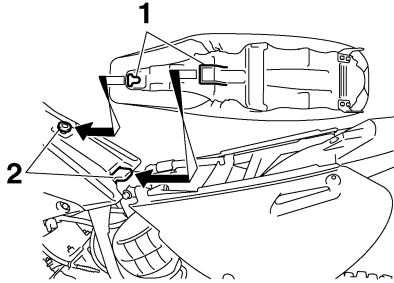

1. Projection
2. Seat holder

2. Place the seat in the original position, and then tighten the bolts.

NOTE:

Make sure that the seat is properly secured before riding.

EAU41470

Adjusting the front fork

This front fork is equipped with rebound damping force adjusting screws and compression damping force adjusting screws.

EWA10180



Always adjust both fork legs equally, otherwise poor handling and loss of stability may result.

Rebound damping force

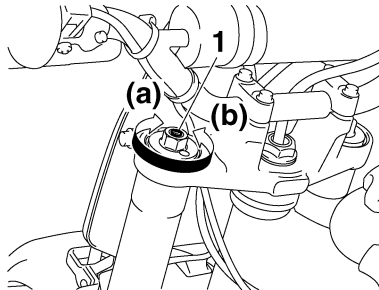

1. Rebound damping force adjusting screw

To increase the rebound damping force and thereby harden the rebound damping, turn the adjusting screw on each fork leg in direction (a). To decrease the rebound damping force and thereby

soften the rebound damping, turn the adjusting screw on each fork leg in direction (b).

Rebound damping setting:

Minimum (soft):

20 click(s) in direction (b)*

Standard:

7 click(s) in direction (b)*

Maximum (hard):

1 click(s) in direction (b)*

* With the adjusting screw fully turned in direction (a)

Compression damping force

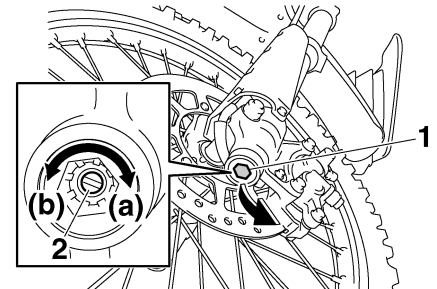

1. Rubber cap
2. Compression damping force adjusting screw

1. Remove the rubber cap by pulling it out of the front fork leg.

2. To increase the compression damping force and thereby harden the compression damping, turn the adjusting screw on each fork leg in direction (a). To decrease the compression damping force and thereby soften the compression damping, turn the adjusting screw on each fork leg in direction (b).

Compression damping setting:

Minimum (soft):

20 click(s) in direction (b)*

Standard:

YZ85(W)/YZ85W1: 10 click(s) in direction (b)*

YZ85LW(W): 9 click(s) in direction (b)*

Maximum (hard):

1 click(s) in direction (b)*

* With the adjusting screw fully turned in direction (a)

3. Install the rubber cap.

ECA10100

CAUTION:

Never attempt to turn an adjusting mechanism beyond the maximum or minimum settings.

NOTE: _____
Although the total number of clicks of a damping force adjusting mechanism may not exactly match the above specifications due to small differences in production, the actual number of clicks always represents the entire adjusting range. To obtain a precise adjustment, it would be advisable to check the number of clicks of each damping force adjusting mechanism and to modify the specifications as necessary.

Front fork bleeding

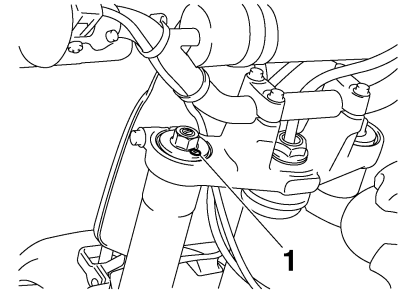

1. Bleed screw

When riding in extremely rough conditions, the air temperature and pressure in the front fork will rise. This will increase the spring preload and harden the front suspension. If this occurs, bleed the front fork as follows.

1. Elevate the front wheel by placing a suitable stand under the engine.

NOTE: _____
When bleeding the front fork, there should be no weight on the front end of the vehicle.

2. Remove the bleed screws and allow all of the air to escape from each fork leg.

INSTRUMENT AND CONTROL FUNCTIONS

3

WARNING

EWA10200

Always bleed both fork legs, otherwise poor handling and loss of stability may result.

3. Install the bleed screws.

EAU41330

Adjusting the shock absorber assembly

This shock absorber assembly is equipped with a spring preload adjusting nut, a rebound damping force adjusting screw and a compression damping force adjusting screw.

ECA10100

CAUTION:

Never attempt to turn an adjusting mechanism beyond the maximum or minimum settings.

Spring preload

Adjust the spring preload as follows.

1. Loosen the locknut.

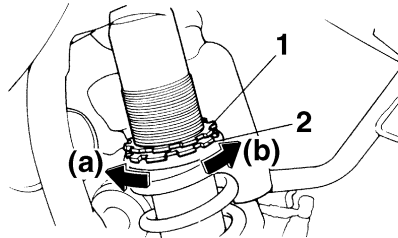

1. Locknut
2. Spring preload adjusting nut

2. To increase the spring preload and thereby harden the suspension, turn the adjusting nut in direction (a). To decrease the spring preload and thereby soften the suspension, turn the adjusting nut in direction (b).

NOTE:

- A special wrench can be obtained at a Yamaha dealer to make this adjustment.
- The spring preload setting is determined by measuring distance A, shown in the illustration. The longer distance A is, the lower the spring preload; the shorter distance A is, the higher the spring preload. With each complete turn of the adjusting nut, distance A is changed by 1.5 mm (0.06 in).

INSTRUMENT AND CONTROL FUNCTIONS

ECA10120

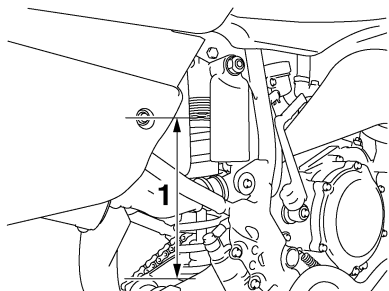

1. Distance A

Spring preload:

Minimum (soft):

Distance A = 218.5 mm (8.60 in)

Standard: YZ85(W)/YZ85W1

Distance A = 215.0 mm (8.46 in)

For Europe only: Distance A =
212.0 mm (8.35 in)

Standard: YZ85LW(W)

Distance A = 207.0 mm (8.15 in)

For Europe only: Distance A =
212.0 mm (8.35 in)

Maximum (hard):

Distance A = 202.5 mm (7.97 in)

3. Tighten the locknut to the specified torque.

Tightening torque:

Locknut:

35 Nm (3.5 m·kgf, 25 ft·lbf)

CAUTION:

Always tighten the locknut against the adjusting nut, and then tighten the locknut to the specified torque.

Rebound damping force

To increase the rebound damping force and thereby harden the rebound damping, turn the adjusting screw in direction (a). To decrease the rebound damping force and thereby soften the rebound damping, turn the adjusting screw in direction (b).

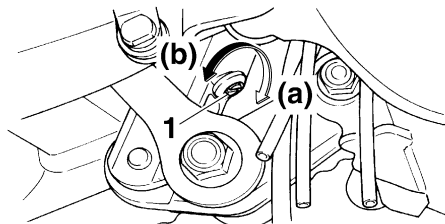

1. Rebound damping force adjusting screw

Rebound damping setting:

Minimum (soft):

20 click(s) in direction (b)*

Standard: YZ85(W)/YZ85W1

6 click(s) in direction (b)*

For Europe only: 12 click(s) in direction (b)*

Standard: YZ85LW(W)

7 click(s) in direction (b)*

For Europe only: 12 click(s) in direction (b)*

Maximum (hard):

1 click(s) in direction (b)*

* With the adjusting screw fully turned in direction (a)

Compression damping force

To increase the compression damping force and thereby harden the compression damping, turn the adjusting screw in direction (a). To decrease the compression damping force and thereby soften the compression damping, turn the adjusting screw in direction (b).

INSTRUMENT AND CONTROL FUNCTIONS

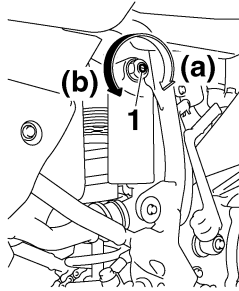

1. Compression damping force adjusting screw

Compression damping setting:

Minimum (soft):

20 click(s) in direction (b)*

Standard: YZ85(W)/YZ85W1

9 click(s) in direction (b)*

For Europe only: 12 click(s) in direction (b)*

Standard: YZ85LW(W)

7 click(s) in direction (b)*

For Europe only: 12 click(s) in direction (b)*

Maximum (hard):

1 click(s) in direction (b)*

* With the adjusting screw fully turned in direction (a)

NOTE:

Although the total number of clicks of a damping force adjusting mechanism may not exactly match the above spec-

ifications due to small differences in production, the actual number of clicks always represents the entire adjusting range. To obtain a precise adjustment, it would be advisable to check the number of clicks of each damping force adjusting mechanism and to modify the specifications as necessary.

EWA10220

WARNING

This shock absorber contains highly pressurized nitrogen gas. For proper handling, read and understand the following information before handling the shock absorber. The manufacturer cannot be held responsible for property damage or personal injury that may result from improper handling.

- **Do not tamper with or attempt to open the gas cylinder.**
- **Do not subject the shock absorber to an open flame or other high heat sources, otherwise it may explode due to excessive gas pressure.**

- **Do not deform or damage the gas cylinder in any way, as this will result in poor damping performance.**
- **Always have a Yamaha dealer service the shock absorber.**

EAU41381

Removable sidestand

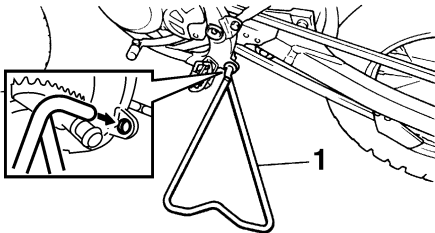

1. Sidestand

This motorcycle is equipped with a removable sidestand.

NOTE: _____

Make sure that the sidestand is properly secured when the motorcycle is being supported or is being transported.

EWA14601

⚠ WARNING _____

- Never apply force on the motorcycle while it is on the sidestand.
- Always remove the sidestand before starting out.

PRE-OPERATION CHECKS

EAU15591

The condition of a vehicle is the owner's responsibility. Vital components can start to deteriorate quickly and unexpectedly, even if the vehicle remains unused (for example, as a result of exposure to the elements). Any damage, fluid leakage or loss of tire air pressure could have serious consequences. Therefore, it is very important, in addition to a thorough visual inspection, to check the following points before each ride.

NOTE:

Pre-operation checks should be made each time the vehicle is used. Such an inspection can be accomplished in a very short time; and the added safety it assures is more than worth the time involved.

EWA11150

4



If any item in the Pre-operation check list is not working properly, have it inspected and repaired before operating the vehicle.

PRE-OPERATION CHECKS

EAU15605

Pre-operation check list

ITEM	CHECKS	PAGE
Fuel	<ul style="list-style-type: none">• Check fuel level in fuel tank.• Always use a fresh mixture of gasoline and oil.• Check fuel line for leakage.	3-3
Transmission oil	<ul style="list-style-type: none">• Check oil level in transmission case.• If necessary, add recommended oil to specified level.	6-9
Coolant	<ul style="list-style-type: none">• Check coolant level.• If necessary, add recommended coolant to specified level.• Check cooling system for leakage.	6-10
Front brake	<ul style="list-style-type: none">• Check operation.• If soft or spongy, have Yamaha dealer bleed hydraulic system.• Check brake pads for wear.• Replace if necessary.• Check fluid level in reservoir.• If necessary, add recommended brake fluid to specified level.• Check hydraulic system for leakage.	6-18, 6-19
Rear brake	<ul style="list-style-type: none">• Check operation.• If soft or spongy, have Yamaha dealer bleed hydraulic system.• Check brake pads for wear.• Replace if necessary.• Check fluid level in reservoir.• If necessary, add recommended brake fluid to specified level.• Check hydraulic system for leakage.	6-18, 6-19
Clutch	<ul style="list-style-type: none">• Check operation.• Lubricate cable if necessary.• Check lever free play.• Adjust if necessary.	6-17
Throttle grip	<ul style="list-style-type: none">• Make sure that operation is smooth.• Check cable free play.• If necessary, have Yamaha dealer adjust cable free play and lubricate cable and grip housing.	6-14, 6-22

PRE-OPERATION CHECKS

ITEM	CHECKS	PAGE
Drive chain	<ul style="list-style-type: none"> • Check chain slack. • Adjust if necessary. • Check chain condition. • Lubricate if necessary. 	6-20, 6-21
Wheels and tires	<ul style="list-style-type: none"> • Check for damage. • Check tire condition and tread depth. • Check air pressure. • Correct if necessary. • Check for loose spokes and tighten if necessary. 	6-15, 6-17
Shift pedal	<ul style="list-style-type: none"> • Make sure that operation is smooth. • Correct if necessary. 	6-23
Brake pedal	<ul style="list-style-type: none"> • Make sure that operation is smooth. • Lubricate pedal pivoting point if necessary. 	6-23
Steering	<ul style="list-style-type: none"> • Check that the handlebar can be turned smoothly and has no excessive play. 	6-25
Front fork and rear shock absorber assembly	<ul style="list-style-type: none"> • Check that they operate smoothly and there is no oil leakage. 	3-7, 3-8, 3-9, 6-24
Chassis fasteners	<ul style="list-style-type: none"> • Make sure that all nuts, bolts and screws are properly tightened. • Tighten if necessary. 	—
Moving parts and cables	<ul style="list-style-type: none"> • Check that the control cables move smoothly. • Check that the control cables are not caught when the handlebars are turned or when the front forks travel up and down. • Lubricate moving parts and cables if necessary. 	6-22, 6-23, 6-24, 6-24
Exhaust system	<ul style="list-style-type: none"> • Check that the exhaust pipe is tightly mounted and has no cracks. • Check for leakage. 	—
Ignition system	<ul style="list-style-type: none"> • Check that all leads and cables are properly connected. 	6-8

OPERATION AND IMPORTANT RIDING POINTS

EAU41400

EWA14610

EAU41300

EAU16660

WARNING

- This model is designed for off-road use only. Become thoroughly familiar with all operating controls and their functions before riding. Consult a Yamaha dealer regarding any control or function that you do not thoroughly understand.
- Never start the engine or operate it in a closed area for any length of time. Exhaust fumes are poisonous, and inhaling them can cause loss of consciousness and death within a short time. Always make sure that there is adequate ventilation.
- Before starting out, make sure that the sidestand is removed. If the sidestand is not removed, it will contact the ground, which could distract the operator or affect the balance of the motor-cycle, resulting in a possible loss of control.

Starting and warming up a cold engine

1. Turn the fuel cock lever to "ON".
2. Shift the transmission into the neutral position.
3. Turn the starter (choke) on and completely close the throttle. (See page 3-6.)
4. Start the engine by pushing the kickstarter lever down.

CAUTION:

For maximum engine life, always warm the engine up before starting off. Never accelerate hard when the engine is cold!

5. When the engine is warm, turn the starter (choke) off.

NOTE:

The engine is warm when it responds normally to the throttle with the starter (choke) turned off.

Starting a warm engine

Follow the same procedure as for starting a cold engine with the exception that the starter (choke) is not required when the engine is warm. Instead, start the engine with the throttle slightly open.

NOTE:

If the engine does not start after several kicks, try again with the throttle 1/4 to 1/2 open.

OPERATION AND IMPORTANT RIDING POINTS

Shifting

EAU16671

ECA10260

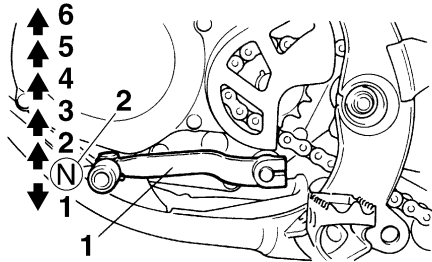

1. Shift pedal
2. Neutral position

Shifting gears lets you control the amount of engine power available for starting off, accelerating, climbing hills, etc.

The gear positions are shown in the illustration.

NOTE:

To shift the transmission into the neutral position, press the shift pedal down repeatedly until it reaches the end of its travel, and then slightly raise it.

CAUTION:

- Even with the transmission in the neutral position, do not coast for long periods of time with the engine off, and do not tow the motorcycle for long distances. The transmission is properly lubricated only when the engine is running. Inadequate lubrication may damage the transmission.
- Always use the clutch while changing gears to avoid damaging the engine, transmission, and drive train, which are not designed to withstand the shock of forced shifting.

EAU16690

To start out and accelerate

1. Pull the clutch lever to disengage the clutch.
2. Shift the transmission into first gear.
3. Open the throttle gradually and simultaneously release the clutch lever slowly.

4. Once the motorcycle has reached a speed high enough to change gears, close the throttle, and at the same time, quickly pull the clutch lever in.
5. Shift the transmission into second gear. (Make sure not to shift the transmission into the neutral position.)
6. Open the throttle halfway and gradually release the clutch lever.
7. Follow the same procedure when shifting to the next gear.

EAU16710

To decelerate

1. Close the throttle and apply both the front and the rear brakes to slow the motorcycle.
2. Downshift through the gears and shift the transmission into the neutral position when the motorcycle is almost completely stopped.

OPERATION AND IMPORTANT RIDING POINTS

Engine break-in

EAU41502

1. Before starting the engine, fill the fuel tank with a break-in oil-fuel mixture as follows.

Recommended 2-stroke engine oil:

See page 8-1.

Mixing ratio (gasoline to oil):

15:1

2. Start and warm up the engine. Check the operation of the controls and the engine stop button. (See page 3-1.)
3. Operate the motorcycle in the lower gears at moderate throttle openings for five to eight minutes. Stop the engine and check the spark plug condition (see page 6-8); it will show a rich condition during break-in.
4. Allow the engine to cool. Restart the engine and operate the motorcycle as in the step above for five minutes. Then, very briefly shift to the higher gears and check the full-throttle response. Stop the engine and check the spark plug.

5. After again allowing the engine to cool, restart and run the motorcycle for five more minutes. Full throttle and the higher gears may be used, but sustained full-throttle operation should be avoided. Stop the engine and check the spark plug again.
6. Allow the engine to cool, remove the cylinder head and cylinder, and inspect the piston and cylinder. Remove any high spots on the piston with #600-grit wet sandpaper. Clean all components and carefully reassemble the cylinder head and cylinder.

EWA10320

WARNING

If you are not familiar with maintenance work, have a Yamaha dealer do it for you.

7. Drain the break-in oil-fuel mixture from the fuel tank and refill with the specified mix. (See page 3-3.)
8. Start the engine and check the operation of the motorcycle throughout its entire operating range. Stop the engine and check the spark

plug condition. Restart the motorcycle and ride it for about 10 to 15 more minutes. The motorcycle will now be ready to ride normally.

After the engine break-in period, thoroughly check the motorcycle for loose parts, oil leakage and any other problems. Be sure to inspect and make adjustments thoroughly, especially cable and drive chain slack and loose spokes. In addition, check all fittings and fasteners for looseness, and tighten if necessary.

ECA15560

CAUTION:

- **When any of the following parts have been replaced, they must be broken in.**

Cylinder or crankshaft:

About one hour of break-in operation is necessary.

Piston, rings or transmission gears:

These parts require about 30 minutes of break-in operation at half-throttle or less. Observe the condition of the engine carefully during operation.

OPERATION AND IMPORTANT RIDING POINTS

- If any engine trouble should occur during the engine break-in period, immediately have a Yamaha dealer check the vehicle.
-

EAU17190

Parking

When parking, stop the engine, and then turn the fuel cock lever to “OFF”.

EWA10310

WARNING

- Since the engine and exhaust system can become very hot, park in a place where pedestrians or children are not likely to touch them.
 - Do not park on a slope or on soft ground, otherwise the vehicle may overturn.
-

PERIODIC MAINTENANCE AND MINOR REPAIR

EAU17240

Safety is an obligation of the owner. Periodic inspection, adjustment and lubrication will keep your vehicle in the safest and most efficient condition possible. The most important points of inspection, adjustment, and lubrication are explained on the following pages. The intervals given in the periodic maintenance and lubrication chart should be simply considered as a general guide under normal riding conditions. However, DEPENDING ON THE WEATHER, TERRAIN, GEOGRAPHICAL LOCATION, AND INDIVIDUAL USE, THE MAINTENANCE INTERVALS MAY NEED TO BE SHORTENED.

EWA10320



If you are not familiar with maintenance work, have a Yamaha dealer do it for you.

PERIODIC MAINTENANCE AND MINOR REPAIR

EAU41794

Periodic maintenance and lubrication chart

The following chart is intended as a general guide to maintenance and lubrication. Bear in mind that such factors as weather, terrain, geographical location, and individual usage will alter the required maintenance and lubrication intervals. If you are in doubt as to what intervals to follow in maintaining and lubricating your motorcycle, consult your Yamaha dealer.

NOTE:

- From the seventh race, repeat the maintenance intervals starting from “Every race”.
- Items marked with an asterisk should be performed by a Yamaha dealer as they require special tools, data and technical skills.

NO.	ITEM	ROUTINE	After break-in	Every race	Every third race	Every fifth race	As required
1	* Piston	• Check piston for carbon deposits and cracks or damage. • Clean.	√	√			
		• Replace.				√	√
2	* Piston rings	• Check piston ring end gap and rings for damage.	√	√			
		• Replace.			√		√
3	* Piston pin and small end bearing	• Check piston pin and small end bearing for damage.		√			
		• Replace.					√
4	* Cylinder head	• Check cylinder head for carbon deposits. • Clean.	√	√			
		• Check cylinder head gasket for damage. • Tighten cylinder head bolts if necessary.	√	√			
		• Replace cylinder head gasket.					√

PERIODIC MAINTENANCE AND MINOR REPAIR

NO.	ITEM	ROUTINE	After break-in	Every race	Every third race	Every fifth race	As required
5	* Cylinder	<ul style="list-style-type: none"> • Check cylinder for score marks or wear. • Clean. 	√	√			
		<ul style="list-style-type: none"> • Replace. 					√
6	* Clutch	<ul style="list-style-type: none"> • Check clutch housing, friction plates, clutch plates and clutch springs for wear or damage. • Adjust. 	√	√			
		<ul style="list-style-type: none"> • Replace. 					√
7	* Transmission	<ul style="list-style-type: none"> • Change the transmission oil. 	√			√	
		<ul style="list-style-type: none"> • Check transmission for damage. 					√
		<ul style="list-style-type: none"> • Replace bearings. 					√
8	* Shift forks, guide bars, shift cam	<ul style="list-style-type: none"> • Check all parts for wear and damage. • Replace if necessary. 					√
9	* Rotor nut (flywheel magneto)	<ul style="list-style-type: none"> • Tighten. 	√			√	
10	* Kickstarter system	<ul style="list-style-type: none"> • Check idle gear for damage. • Replace if necessary. 					√
11	* Exhaust system	<ul style="list-style-type: none"> • Check exhaust pipe and muffler for carbon deposits. 	√	√			
		<ul style="list-style-type: none"> • Clean. 				√	
12	* Crankshaft	<ul style="list-style-type: none"> • Check crankshaft for carbon deposits and damage. 				√	√
		<ul style="list-style-type: none"> • Clean. 				√	√

PERIODIC MAINTENANCE AND MINOR REPAIR

NO.	ITEM	ROUTINE	After break-in	Every race	Every third race	Every fifth race	As required
13	* Carburetor	• Check carburetor settings and for obstructions.	√	√			
		• Adjust and clean.	√	√			
14	* Spark plug	• Check condition. • Clean and regap.	√	√			
		• Replace.					√
15	* Drive chain	• Check chain slack, alignment and condition. • Adjust and thoroughly lubricate chain with Yamaha chain and cable lube or equivalent.	√	√			
		• Replace.					√
16	* Cooling system	• Check coolant level and for leakage.	√	√			
		• Check hoses for cracks or damage.		√			
		• Check radiator cap spring operation.					√
		• Change coolant.		Every 2 years			
17	* Chassis fasteners	• Check all chassis fitting and fasteners. • Correct or tighten if necessary.	√	√			
18	* Air filter element	• Clean.	√	√			
		• Replace.					√
19	* Frame	• Clean and check for damage.	√	√			
20	* Fuel line	• Clean and check for leakage.	√		√		

PERIODIC MAINTENANCE AND MINOR REPAIR

NO.	ITEM	ROUTINE	After break-in	Every race	Every third race	Every fifth race	As required
21	* Brakes	<ul style="list-style-type: none"> • Adjust lever position and pedal height. • Lubricate pivot points. • Check brake disk surface. • Check fluid level and for leakage. • Tighten brake disk bolts, caliper bolts, master cylinder bolts and union bolts. 	√	√			
		<ul style="list-style-type: none"> • Replace brake pads. 					√
		<ul style="list-style-type: none"> • Replace brake fluid. 	Every year				√
22	* Front fork	<ul style="list-style-type: none"> • Check operation and for oil leakage. • Adjust if necessary. • Clean dust seal and lubricate with lithium-soap-based grease. 	√	√			
		<ul style="list-style-type: none"> • Replace fork oil. 	√			√	
		<ul style="list-style-type: none"> • Replace oil seals. 					√
23	* Shock absorber assembly	<ul style="list-style-type: none"> • Check operation and adjust. • Tighten if necessary. 	√	√			
		<ul style="list-style-type: none"> • Lubricate with molybdenum disulfide grease. 			√		√ (After washing the motorcycle or riding in the rain)

PERIODIC MAINTENANCE AND MINOR REPAIR

NO.	ITEM	ROUTINE	After break-in	Every race	Every third race	Every fifth race	As required
24	* Drive chain roller and support guide	<ul style="list-style-type: none"> • Check for wear or damage. • Replace if necessary. 					√
25	* Rear suspension	• Check operation and tighten if necessary.	√	√			
		• Lubricate with molybdenum disulfide grease.	√	√			
26	* Steering head	• Check operation, free play, and tighten if necessary.	√	√			
		• Clean and lubricate with lithium-soap-based grease.				√	
		• Replace bearings.					√
27	* Tires and wheels	• Check tire air pressure, wheel runout, spokes for looseness, and tires for wear.	√	√			
		• Tighten sprocket bolts if necessary.	√	√			
		• Check wheel bearings for looseness.				√	
		• Lubricate wheel bearings with lithium-soap-based grease.				√	
		• Replace wheel bearings.					
28	* Moving parts and cables	• Lubricate.	√	√			
29	* Throttle grip housing and cable	<ul style="list-style-type: none"> • Check operation and free play. • Adjust the throttle cable free play if necessary. • Lubricate the throttle grip housing and cable. 	√	√			

6

EAU42010

NOTE:

- Hydraulic brake service
 - Regularly check and, if necessary, correct the brake fluid level.

PERIODIC MAINTENANCE AND MINOR REPAIR

- Every two years replace the internal components of the brake master cylinders and calipers, and change the brake fluid.
 - Replace the brake hoses every four years and if cracked or damaged.
-

PERIODIC MAINTENANCE AND MINOR REPAIR

EAU19612

Checking the spark plug

The spark plug is an important engine component, which is easy to check. Since heat and deposits will cause any spark plug to slowly erode, the spark plug should be removed and checked in accordance with the periodic maintenance and lubrication chart. In addition, the condition of the spark plug can reveal the condition of the engine.

To remove the spark plug

1. Remove the spark plug cap.

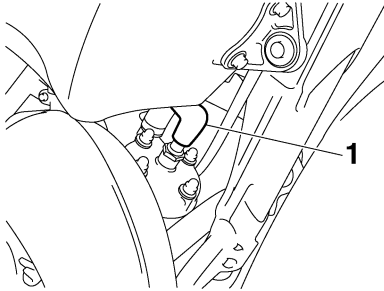

1. Spark plug cap

2. Remove the spark plug as shown, with a spark plug wrench available at a Yamaha dealer.

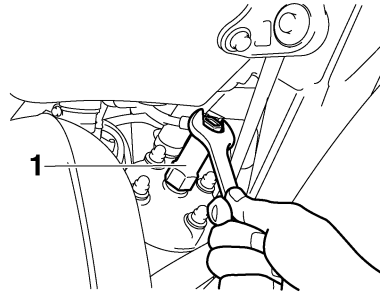

1. Spark plug wrench

To check the spark plug

1. Check that the porcelain insulator around the center electrode of the spark plug is a medium-to-light tan (the ideal color when the vehicle is ridden normally).

NOTE:

If the spark plug shows a distinctly different color, the engine could be operating improperly. Do not attempt to diagnose such problems yourself. Instead, have a Yamaha dealer check the vehicle.

2. Check the spark plug for electrode erosion and excessive carbon or other deposits, and replace it if necessary.

Specified spark plug:
NGK/BR10EG

To install the spark plug

1. Measure the spark plug gap with a wire thickness gauge and, if necessary, adjust the gap to specification.

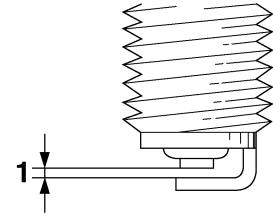

1. Spark plug gap

Spark plug gap:
0.5–0.6 mm (0.020–0.024 in)

PERIODIC MAINTENANCE AND MINOR REPAIR

2. Clean the surface of the spark plug gasket and its mating surface, and then wipe off any grime from the spark plug threads.
3. Install the spark plug with the spark plug wrench, and then tighten it to the specified torque.

Tightening torque:

Spark plug:
20 Nm (2.0 m·kgf, 14 ft·lbf)

NOTE:

If a torque wrench is not available when installing a spark plug, a good estimate of the correct torque is 1/4–1/2 turn past finger tight. However, the spark plug should be tightened to the specified torque as soon as possible.

4. Install the spark plug cap.

Transmission oil

EAU41441

The transmission oil must be checked for oil leakage before each ride. If any leakage is found, have a Yamaha dealer check and repair the motorcycle. In addition, the transmission oil must be changed at the intervals specified in the periodic maintenance and lubrication chart.

1. Start the engine, warm it up for several minutes, and then turn it off.
2. Place the motorcycle on a level surface and hold it in an upright position.
3. Place an oil pan under the transmission to collect the used oil.
4. Remove the oil filler cap and drain bolt to drain the oil from the transmission.

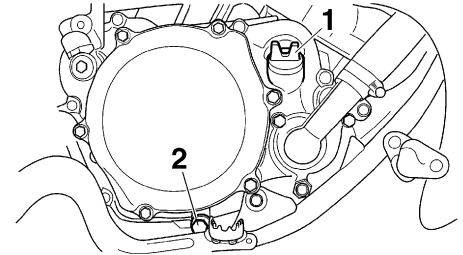

1. Oil filler cap
2. Transmission oil drain bolt

5. Install the transmission oil drain bolt, and then tighten it to the specified torque.

Tightening torque:

Transmission oil drain bolt:
10 Nm (1.0 m·kgf, 7.2 ft·lbf)

6. Add the specified amount of the recommended transmission oil, and then install and tighten the oil filler cap.

Recommended transmission oil:

See page 8-1.

Oil change quantity:

0.50 L (0.53 US qt) (0.44 Imp.qt)

PERIODIC MAINTENANCE AND MINOR REPAIR

ECA10452

CAUTION:

- In order to prevent clutch slippage (since the transmission oil also lubricates the clutch), do not mix any chemical additives. Do not use oils with a diesel specification of “CD” or oils of a higher quality than specified. In addition, do not use oils labeled “ENERGY CONSERVING II” or higher.
- Make sure that no foreign material enters the transmission.

6

7. Start the engine, and then let it idle for several minutes while checking the transmission for oil leakage. If oil is leaking, immediately turn the engine off and check for the cause.

EAU20070

Coolant

The coolant level should be checked before each ride. In addition, the coolant must be changed at the intervals specified in the periodic maintenance and lubrication chart.

EAUM1291

To check the coolant level

1. Place the vehicle on a level surface and hold it in an upright position.

EWA10380



Never attempt to remove the radiator cap when the engine is hot.

2. Remove the radiator cap and check the coolant level in the radiator.

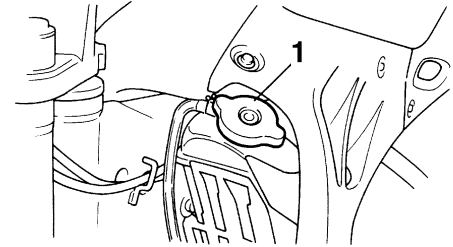

1. Radiator cap

NOTE:

- The coolant level must be checked on a cold engine since the level varies with engine temperature.
- Make sure that the vehicle is positioned straight up when checking the coolant level. A slight tilt to the side can result in a false reading.

NOTE:

The coolant should be at the brim of the radiator filler. The level will change with variation of engine temperature.

PERIODIC MAINTENANCE AND MINOR REPAIR

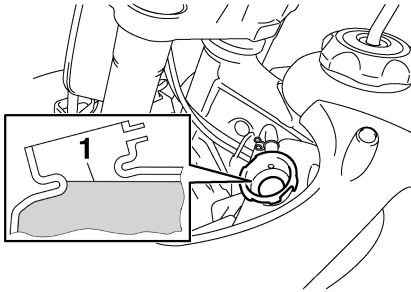

1. Correct coolant level

3. If the coolant is below this level, add coolant, and then install the radiator cap.

NOTE:

If the engine overheats, see page 6-30 for further instructions.

EAUM1311

To change the coolant

1. Place the vehicle on a level surface and let the engine cool if necessary.
2. Place a container under the engine to collect the used coolant.

⚠ WARNING

EWA10380

Never attempt to remove the radiator cap when the engine is hot.

3. Remove the radiator cap.

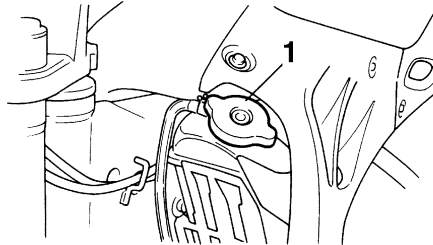

1. Radiator cap

4. Remove the coolant drain bolt to drain the cooling system.

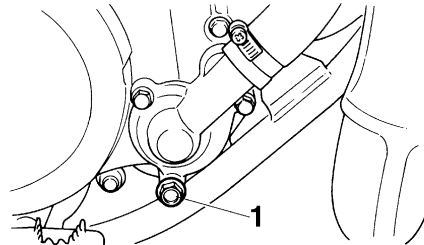

1. Coolant drain bolt

5. After the coolant is completely drained, thoroughly flush the cooling system with clean tap water.
6. Install the coolant drain bolt, and then tighten it to the specified torque.

NOTE:

Check the washer for damage and replace it if necessary.

Tightening torque:

Coolant drain bolt:
10 Nm (1.0 m·kgf, 7.2 ft·lbf)

7. Pour the recommended coolant into the radiator until it is full.

Antifreeze/water mixture ratio:

1:1

Recommended antifreeze:

High-quality ethylene glycol antifreeze containing corrosion inhibitors for aluminum engines

Coolant quantity:

Radiator capacity (including all routes):
0.54 L (0.57 US qt) (0.48 Imp.qt)

PERIODIC MAINTENANCE AND MINOR REPAIR

ECA10471

CAUTION:

- If coolant is not available, use distilled water or soft tap water instead. Do not use hard water or salt water since it is harmful to the engine.
- If water has been used instead of coolant, replace it with coolant as soon as possible, otherwise the cooling system will not be protected against frost and corrosion.
- If water has been added to the coolant, have a Yamaha dealer check the antifreeze content of the coolant as soon as possible, otherwise the effectiveness of the coolant will be reduced.

6

8. Install the radiator cap, start the engine, let it idle for several minutes, and then turn it off.
9. Remove the radiator cap to check the coolant level in the radiator. If necessary, add sufficient coolant until it reaches the top of the radiator, and then install the radiator cap.

10. Start the engine, and then check the vehicle for coolant leakage. If coolant is leaking, have a Yamaha dealer check the cooling system.

EAU41431

Cleaning the air filter element

The air filter element should be cleaned at the intervals specified in the periodic maintenance and lubrication chart. Clean the air filter element more frequently if you are riding in unusually wet or dusty areas.

1. Remove the seat. (See page 3-6.)
2. Remove the air filter case cover as shown.

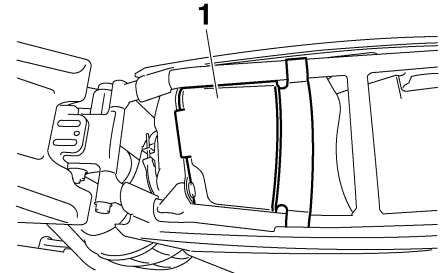

1. Air filter case cover

PERIODIC MAINTENANCE AND MINOR REPAIR

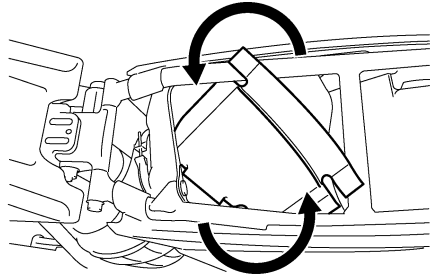

3. Remove the air filter element by removing the wing bolt and washer.

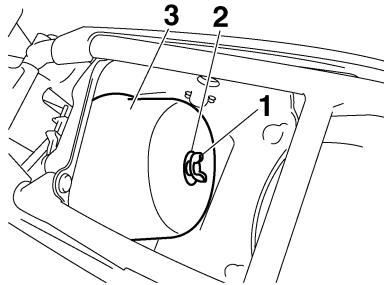

1. Wing bolt
2. Washer
3. Sponge material

4. Remove the sponge material from the air filter element frame.

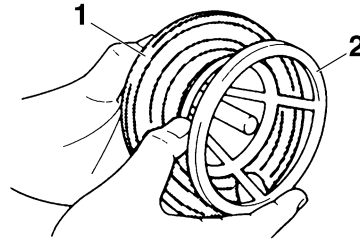

1. Sponge material
2. Air filter element frame

5. Clean the sponge material with solvent, and then squeeze the remaining solvent out.

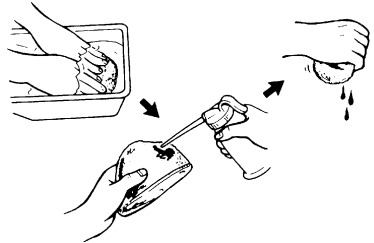

6. Apply oil of the recommended type to the entire surface of the sponge material, and then squeeze the excess oil out.

NOTE: _____
The sponge material should be wet but not dripping.

Recommended oil:

Yamaha foam air filter oil or other quality foam air filter oil

7. Pull the sponge material over the air filter element frame.
8. Insert the air filter element into the air filter case with the projection facing upward, and then install the washer and wing bolt.

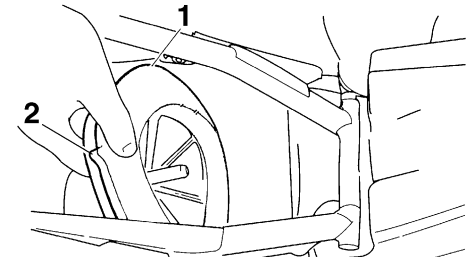

1. Sponge material
2. Projection

PERIODIC MAINTENANCE AND MINOR REPAIR

ECA10480

CAUTION:

- Make sure that the air filter element is properly seated in the air filter case.
- The engine should never be operated without the air filter element installed, otherwise the piston(s) and/or cylinder(s) may become excessively worn.

9. Install the air filter case cover in the original position as shown.

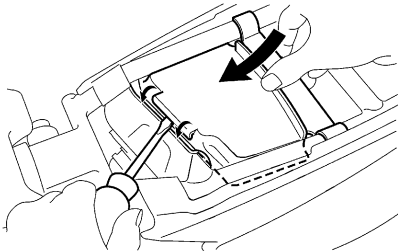

10. Install the seat.

6

EAU39930

Adjusting the carburetor

The carburetor is an important part of the engine and requires very sophisticated adjustment. Therefore, most carburetor adjustments should be left to a Yamaha dealer, who has the necessary professional knowledge and experience. The adjustment described in the following section, however, may be serviced by the owner as part of routine maintenance.

CAUTION:

The carburetor has been set and extensively tested at the Yamaha factory. Changing these settings without sufficient technical knowledge may result in poor performance of or damage to the engine.

ECA10550

EAU21370

Adjusting the throttle cable free play

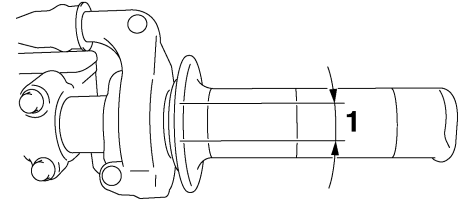

1. Throttle cable free play

The throttle cable free play should measure 3.0–5.0 mm (0.12–0.20 in) at the throttle grip. Periodically check the throttle cable free play and, if necessary, adjust it as follows.

NOTE:

The engine idling speed must be correctly adjusted before checking and adjusting the throttle cable free play.

1. Loosen the locknut.

PERIODIC MAINTENANCE AND MINOR REPAIR

- To increase the throttle cable free play, turn the adjusting nut in direction (a). To decrease the throttle cable free play, turn the adjusting nut in direction (b).

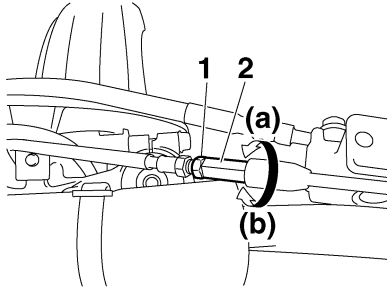

- Locknut
- Throttle cable free play adjusting nut
- Tighten the locknut.

Tires

To maximize the performance, durability, and safe operation of your motorcycle, note the following points regarding the specified tires.

Tire air pressure

The tire air pressure should be checked and, if necessary, adjusted before each ride.

⚠ WARNING

- The tire air pressure must be checked and adjusted on cold tires (i.e., when the temperature of the tires equals the ambient temperature).
- The tire air pressure must be adjusted in accordance with the weight of the rider, the riding speed, and the riding conditions.

Standard tire air pressure:

Front:
100 kPa (15 psi) (1.00 kgf/cm²)
Rear:
100 kPa (15 psi) (1.00 kgf/cm²)

EAU41820

Tire inspection

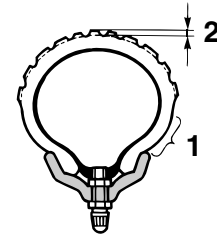

- Tire sidewall
- Tire tread depth

The tires must be checked before each ride.

CAUTION:

- Be sure the bead stoppers are tightened. Loose bead stoppers will cause the tire to slip off the rim if tire pressure is too low.
- Be sure the valve stem is positioned straight. A tilted valve stem indicates that the tire has slipped from its original position on the rim. Rotate the tire so that the valve stem is positioned straight.

EWA14380

ECA15580

PERIODIC MAINTENANCE AND MINOR REPAIR

If the center tread depth reaches the specified limit, if the tire has a nail or glass fragments in it, or if the sidewall is cracked, have a Yamaha dealer replace the tire immediately.

Minimum tire tread depth (front and rear):
4.0 mm (0.16 in)

Tire information

This motorcycle is equipped with spoke wheels and tube tires.

EWA10460

WARNING

- The front and rear tires should be of the same make and design, otherwise the handling characteristics of the vehicle cannot be guaranteed.
- After extensive tests, only the tires listed below have been approved for this model by Yamaha Motor Co., Ltd.

Front tire:

Size:

YZ85 70/100-17 40M
YZ85LW 70/100-19 42M
YZ85LWW 70/100-19 42M
YZ85W 70/100-17 40M
YZ85W1 70/100-17 40M

Manufacturer/model:

YZ85 DUNLOP/D739FA (ZAF)
YZ85 DUNLOP/D756F
(AUT)(BEL)(CHE)(DEU)(DNK)(ESP)(FIN)(FRA)(GBR)(GRC)(IRL)(NLD)(NOR)(PRT)(SWE)
YZ85LW DUNLOP/D756F
YZ85LWW DUNLOP/D756F
YZ85W DUNLOP/D756F
YZ85W1 DUNLOP/D756F

Rear tire:

Size:

YZ85 90/100-14 49M
YZ85LW 90/100-16 52M
YZ85LWW 90/100-16 52M
YZ85W 90/100-14 49M
YZ85W1 90/100-14 49M

Manufacturer/model:

DUNLOP/D756

EWA14390

WARNING

- Have a Yamaha dealer replace excessively worn tires. Operating the motorcycle with exces-

sively worn tires decreases riding stability and can lead to loss of control.

- The replacement of all wheel- and brake-related parts, including the tires, should be left to a Yamaha dealer, who has the necessary professional knowledge and experience.
- It is not recommended to patch a punctured tube. If unavoidable, however, patch the tube very carefully and replace it as soon as possible with a high-quality product.

Spoke wheels

EAU21940

To maximize the performance, durability, and safe operation of your motorcycle, note the following points regarding the specified wheels.

- The wheel rims should be checked for cracks, bends or warpage, and the spokes for looseness or damage before each ride. If any damage is found, have a Yamaha dealer replace the wheel. Do not attempt even the smallest repair to the wheel. A deformed or cracked wheel must be replaced.
- The wheel should be balanced whenever either the tire or wheel has been changed or replaced. An unbalanced wheel can result in poor performance, adverse handling characteristics, and a shortened tire life.
- Ride at moderate speeds after changing a tire since the tire surface must first be “broken in” for it to develop its optimal characteristics.

Accessories and replacement parts

EAU40431

EWA14481

⚠ WARNING

The accessories or replacement parts you choose for your vehicle should be designed specifically for this model, and they must be securely mounted to maintain the inherent stability of the original design. Genuine Yamaha Parts and Accessories are designed and tested to be compatible with your vehicle. Yamaha recommends the use of Genuine Yamaha Parts and Accessories before making a purchase. Use of non-Yamaha-approved accessories or replacement parts may cause loss of handling stability and riding safety. Since Yamaha cannot control the quality of accessories or parts manufactured by other companies, Yamaha cannot be held liable for any consequences caused by the use of items which have not been approved by Yamaha.

Adjusting the clutch lever free play

EAU22031

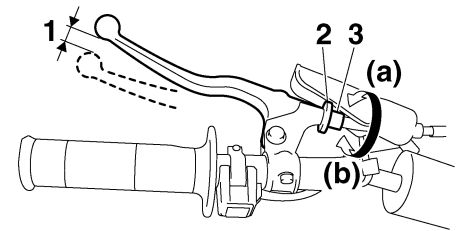

1. Clutch lever free play
2. Locknut (clutch lever)
3. Adjusting bolt

The clutch lever free play should measure 10.0–15.0 mm (0.39–0.59 in) as shown. Periodically check the clutch lever free play and, if necessary, adjust it as follows.

1. Loosen the locknut at the clutch lever.
2. To increase the clutch lever free play, turn the adjusting bolt in direction (a). To decrease the clutch lever free play, turn the adjusting bolt in direction (b).

PERIODIC MAINTENANCE AND MINOR REPAIR

3. If the specified clutch lever free play could be obtained as described above, tighten the locknut and skip the rest of the procedure, otherwise, proceed as follows.
4. Fully turn the adjusting bolt in direction (a) to loosen the clutch cable.
5. Loosen the locknut further down the clutch cable.

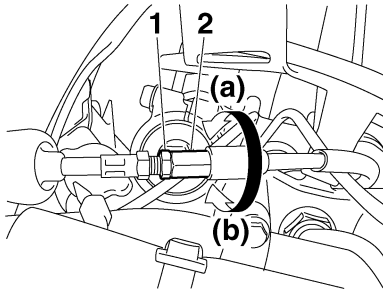

1. Locknut (clutch cable)
2. Adjusting nut

6. To increase the clutch lever free play, turn the adjusting nut in direction (a). To decrease the clutch lever free play, turn the adjusting nut in direction (b).
7. Tighten both locknuts.

Checking the front and rear brake pads

EAU22390

The front and rear brake pads must be checked for wear at the intervals specified in the periodic maintenance and lubrication chart.

Front brake pads

EAU22400

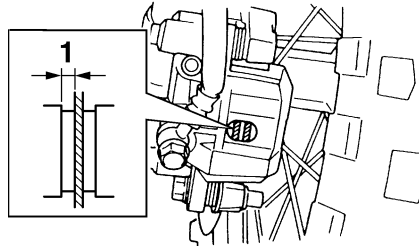

1. Lining thickness

Check each front brake pad for damage and measure the lining thickness. If a brake pad is damaged or if the lining thickness is less than 0.8 mm (0.03 in), have a Yamaha dealer replace the brake pads as a set.

Rear brake pads

EAU22500

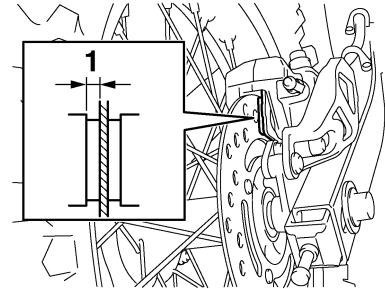

1. Lining thickness

Check each rear brake pad for damage and measure the lining thickness. If a brake pad is damaged or if the lining thickness is less than 1.0 mm (0.04 in), have a Yamaha dealer replace the brake pads as a set.

PERIODIC MAINTENANCE AND MINOR REPAIR

Checking the brake fluid level EAU22580

Front brake

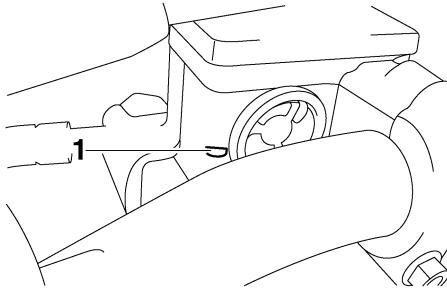

1. Minimum level mark

Rear brake

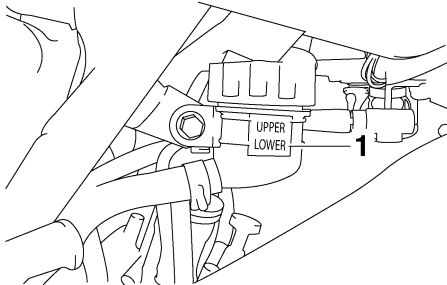

1. Minimum level mark

Insufficient brake fluid may allow air to enter the brake system, possibly causing it to become ineffective.

Before riding, check that the brake fluid is above the minimum level mark and replenish if necessary. A low brake fluid level may indicate worn brake pads and/or brake system leakage. If the brake fluid level is low, be sure to check the brake pads for wear and the brake system for leakage.

Observe these precautions:

- When checking the fluid level, make sure that the top of the brake fluid reservoir is level.
- Use only the recommended quality brake fluid, otherwise the rubber seals may deteriorate, causing leakage and poor braking performance.

Recommended brake fluid:
DOT 4

- Refill with the same type of brake fluid. Mixing fluids may result in a harmful chemical reaction and lead to poor braking performance.

- Be careful that water does not enter the brake fluid reservoir when refilling. Water will significantly lower the boiling point of the fluid and may result in vapor lock.
- Brake fluid may deteriorate painted surfaces or plastic parts. Always clean up spilled fluid immediately.
- As the brake pads wear, it is normal for the brake fluid level to gradually go down. However, if the brake fluid level goes down suddenly, have a Yamaha dealer check the cause.

PERIODIC MAINTENANCE AND MINOR REPAIR

Changing the brake fluid

EAU22730

Have a Yamaha dealer change the brake fluid at the intervals specified in the NOTE after the periodic maintenance and lubrication chart. In addition, have the oil seals of the master cylinders and calipers as well as the brake hoses replaced at the intervals listed below or whenever they are damaged or leaking.

- Oil seals: Replace every two years.
- Brake hoses: Replace every four years.

Drive chain slack

EAU22760

The drive chain slack should be checked before each ride and adjusted if necessary.

To check the drive chain slack

EAU41410

1. Install the removable sidestand and place the motorcycle on it.

NOTE:

When checking and adjusting the drive chain slack, there should be no weight on the motorcycle.

2. Shift the transmission into the neutral position.
3. Move the rear wheel by pushing the motorcycle to locate the tightest portion of the drive chain, and then measure the drive chain slack as shown.

Drive chain slack:

35.0–45.0 mm (1.38–1.77 in)

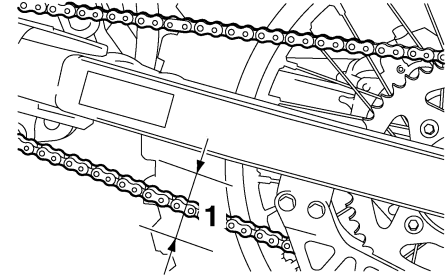

1. Drive chain slack

4. If the drive chain slack is incorrect, adjust it as follows.

To adjust the drive chain slack

EAU41480

1. Loosen the axle nut and the locknut on each side of the swingarm.
2. To tighten the drive chain, turn the adjusting bolt on each side of the swingarm in direction (a). To loosen the drive chain, turn the adjusting bolt on each side of the swingarm in direction (b), and then push the rear wheel forward.

PERIODIC MAINTENANCE AND MINOR REPAIR

NOTE:

Using the alignment marks on each chain puller, make sure that both chain pullers are in the same position for proper wheel alignment.

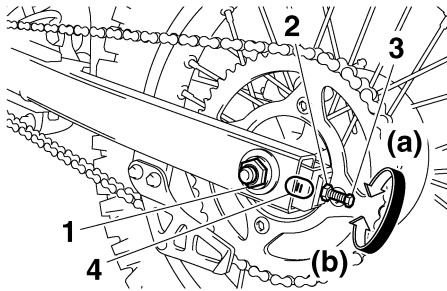

1. Axle nut
2. Locknut
3. Drive chain slack adjusting bolt
4. Alignment marks

ECA10570

CAUTION:

Improper drive chain slack will overload the engine as well as other vital parts of the motorcycle and can lead to chain slippage or breakage. To prevent this from occurring, keep the drive chain slack within the specified limits.

3. Tighten both locknuts and the axle nut to the specified torques.

Tightening torques:

Locknut:

16 Nm (1.6 m·kgf, 11 ft·lbf)

Axle nut:

90 Nm (9.0 m·kgf, 65 ft·lbf)

EAU23013

Cleaning and lubricating the drive chain

The drive chain must be cleaned and lubricated at the intervals specified in the periodic maintenance and lubrication chart, otherwise it will quickly wear out, especially when riding in dusty or wet areas. Service the drive chain as follows.

ECA10581

CAUTION:

The drive chain must be lubricated after washing the motorcycle and riding in the rain.

1. Remove all dirt and mud from the drive chain with a brush or cloth.

NOTE:

For a thorough cleaning, have a Yamaha dealer remove the drive chain and soak it in solvent.

2. Spray Yamaha Chain and Cable Lube or a high-quality spray-type drive chain lubricant on both sides and on the middle of the chain,

PERIODIC MAINTENANCE AND MINOR REPAIR

making sure that all side plates and rollers have been sufficiently oiled.

Checking and lubricating the cables

EAU41840

The operation of all control cables and the condition of the cables should be checked before each ride, and the cables and cable ends should be lubricated if necessary. If a cable is damaged or does not move smoothly, have a Yamaha dealer check or replace it.

Recommended lubricant:

Yamaha Chain and Cable Lube or engine oil SAE 10W-30 (API SE)

EWA10710

WARNING

Damage to the outer housing of cables may result in internal rusting and cause interference with cable movement. Replace damaged cables as soon as possible to prevent unsafe conditions.

Checking and lubricating the throttle grip and cable

EAU23111

The operation of the throttle grip should be checked before each ride. In addition, the cable should be lubricated at the intervals specified in the periodic maintenance chart.

PERIODIC MAINTENANCE AND MINOR REPAIR

Checking and lubricating the brake and shift pedals

EAU23131

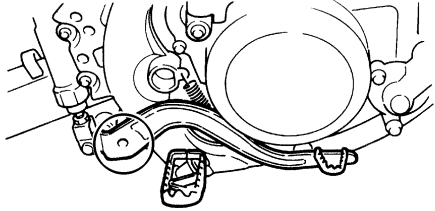

The operation of the brake and shift pedals should be checked before each ride, and the pedal pivots should be lubricated if necessary.

Recommended lubricant:

Lithium-soap-based grease (all-purpose grease)

Checking and lubricating the brake and clutch levers

EAU23140

Brake lever

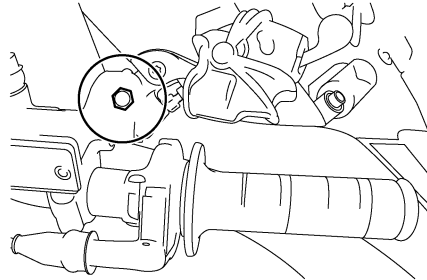

Clutch lever

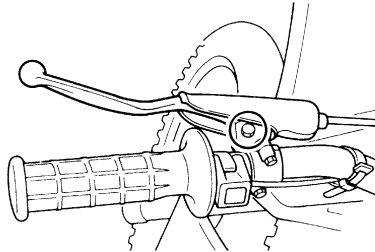

The operation of the brake and clutch levers should be checked before each ride, and the lever pivots should be lubricated if necessary.

Recommended lubricant:

Lithium-soap-based grease (all-purpose grease)

PERIODIC MAINTENANCE AND MINOR REPAIR

Lubricating the swingarm pivots

EAUM1650

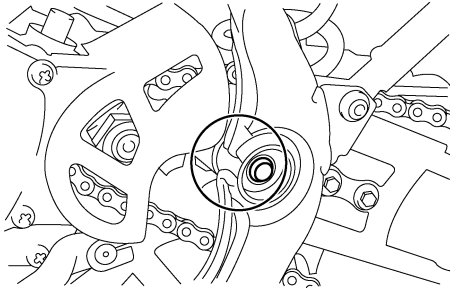

The swingarm pivots must be lubricated at the intervals specified in the periodic maintenance and lubrication chart.

Recommended lubricant:
Lithium-soap-based grease

Lubricating the rear suspension

EAU23250

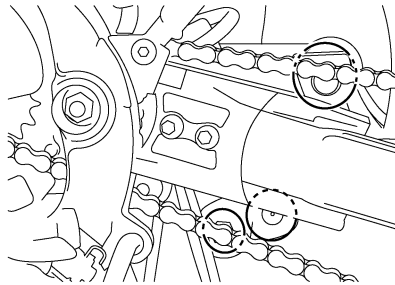

The pivoting points of the rear suspension must be lubricated at the intervals specified in the periodic maintenance and lubrication chart.

Recommended lubricant:
Lithium-soap-based grease

Checking the front fork

EAU23271

The condition and operation of the front fork must be checked as follows at the intervals specified in the periodic maintenance and lubrication chart.

To check the condition

EWA10750

⚠ WARNING

Securely support the vehicle so that there is no danger of it falling over.

Check the inner tubes for scratches, damage and excessive oil leakage.

To check the operation

1. Place the vehicle on a level surface and hold it in an upright position.
2. While applying the front brake, push down hard on the handlebars several times to check if the front fork compresses and rebounds smoothly.

PERIODIC MAINTENANCE AND MINOR REPAIR

EAU23280

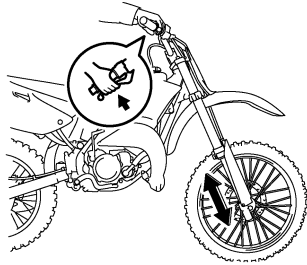

ECA10590

CAUTION:

If any damage is found or the front fork does not operate smoothly, have a Yamaha dealer check or repair it.

Checking the steering

Worn or loose steering bearings may cause danger. Therefore, the operation of the steering must be checked as follows at the intervals specified in the periodic maintenance and lubrication chart.

1. Place a stand under the engine to raise the front wheel off the ground.

EWA10750

WARNING

Securely support the vehicle so that there is no danger of it falling over.

2. Hold the lower ends of the front fork legs and try to move them forward and backward. If any free play can be felt, have a Yamaha dealer check or repair the steering.

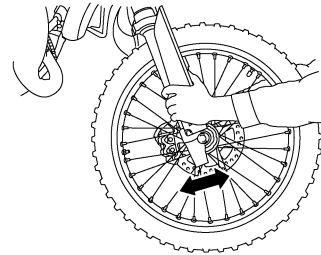

PERIODIC MAINTENANCE AND MINOR REPAIR

EAU23290

Checking the wheel bearings

The front and rear wheel bearings must be checked at the intervals specified in the periodic maintenance and lubrication chart. If there is play in the wheel hub or if the wheel does not turn smoothly, have a Yamaha dealer check the wheel bearings.

EAU24350

Supporting the motorcycle

Since this model is not equipped with a centerstand, follow these precautions when removing the front and rear wheel or performing other maintenance requiring the motorcycle to stand upright. Check that the motorcycle is in a stable and level position before starting any maintenance. A strong wooden box can be placed under the engine for added stability.

a jack either under each side of the frame in front of the rear wheel or under each side of the swingarm.

To service the front wheel

1. Stabilize the rear of the motorcycle by using a motorcycle stand or, if an additional motorcycle stand is not available, by placing a jack under the frame in front of the rear wheel.
2. Raise the front wheel off the ground by using a motorcycle stand.

To service the rear wheel

Raise the rear wheel off the ground by using a motorcycle stand or, if a motorcycle stand is not available, by placing

PERIODIC MAINTENANCE AND MINOR REPAIR

Front wheel

EAU24360

To remove the front wheel

EAU41340

EWA10820

WARNING

- It is advisable to have a Yamaha dealer service the wheel.
- Securely support the motorcycle so that there is no danger of it falling over.

1. Loosen the axle nut.

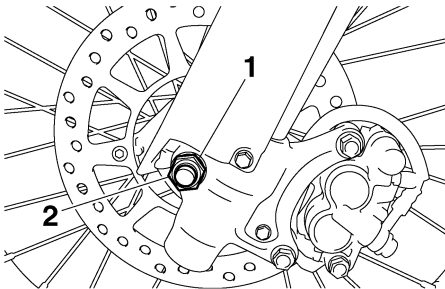

1. Washer
2. Axle nut

2. Lift the front wheel off the ground according to the procedure on page 6-26.
3. Remove the axle nut and washer.

4. Pull the wheel axle out, and then remove the wheel.

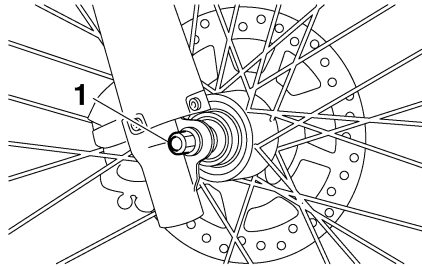

1. Wheel axle

To install the front wheel

EAU41420

1. Lift the wheel up between the fork legs.
2. Insert the wheel axle from the right side.
3. Lower the front wheel so that it is on the ground.
4. Install the washer and axle nut, and then tighten the axle nut to the specified torque.

Tightening torque:

Axle nut:
70 Nm (7.0 m·kgf, 50 ft·lbf)

Rear wheel

EAU25080

To remove the rear wheel

EAU41310

EWA10820

WARNING

- It is advisable to have a Yamaha dealer service the wheel.
- Securely support the motorcycle so that there is no danger of it falling over.

1. Loosen the axle nut.
2. Lift the rear wheel off the ground according to the procedure on page 6-26.
3. Loosen the locknut and drive chain adjusting bolt on each side of the swingarm.
4. Remove the axle nut and washer.

PERIODIC MAINTENANCE AND MINOR REPAIR

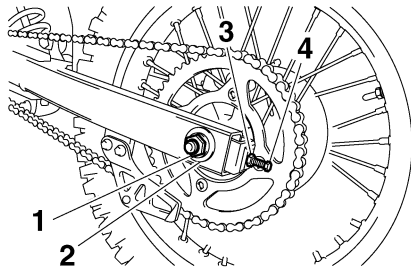

1. Axle nut
2. Washer
3. Locknut
4. Drive chain slack adjusting bolt

5. Push the wheel forward, and then remove the drive chain from the rear sprocket.

NOTE: _____

- If the drive chain is difficult to remove, remove the wheel axle first, and then lift the wheel upward enough to remove the drive chain from the rear sprocket.
- The drive chain cannot be disassembled.

6. While supporting the brake caliper and slightly lifting the wheel, pull the wheel axle out.

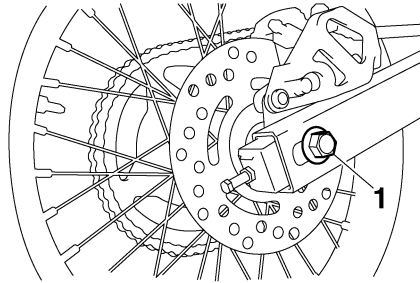

1. Wheel axle

NOTE: _____

A rubber mallet may be useful to tap the wheel axle out.

7. Remove the wheel.

ECA11070

CAUTION: _____

Do not apply the brake after the wheel has been removed together with the brake disc, otherwise the brake pads will be forced shut.

EAU41320

To install the rear wheel

1. Install the wheel and the brake caliper bracket by inserting the wheel axle from the right-hand side.

NOTE: _____

- Make sure that the retainer on the swingarm is inserted into the slot in the brake caliper bracket.
- Make sure that there is enough space between the brake pads before installing the wheel.

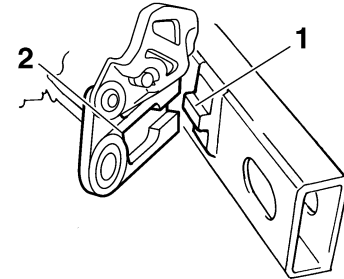

1. Retainer
2. Slot

2. Install the drive chain onto the rear sprocket.
3. Install the washer and axle nut, and then lower the rear wheel so that it is on the ground.
4. Adjust the drive chain slack. (See page 6-20.)
5. Tighten the axle nut to the specified torque.

Tightening torque:

Axle nut:

90 Nm (9.0 m·kgf, 65 ft·lbf)

EAU25870

Troubleshooting

Although Yamaha motorcycles receive a thorough inspection before shipment from the factory, trouble may occur during operation. Any problem in the fuel, compression, or ignition systems, for example, can cause poor starting and loss of power.

The following troubleshooting charts represent quick and easy procedures for checking these vital systems yourself. However, should your motorcycle require any repair, take it to a Yamaha dealer, whose skilled technicians have the necessary tools, experience, and know-how to service the motorcycle properly.

Use only genuine Yamaha replacement parts. Imitation parts may look like Yamaha parts, but they are often inferior, have a shorter service life and can lead to expensive repair bills.

PERIODIC MAINTENANCE AND MINOR REPAIR

EAU41491

Troubleshooting charts

Starting problems or poor engine performance

EWA10840



WARNING

Keep away open flames and do not smoke while checking or working on the fuel system.

1. Fuel

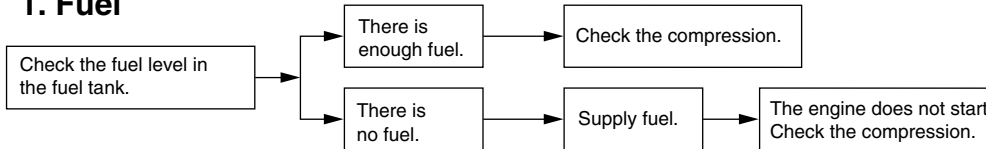

2. Compression

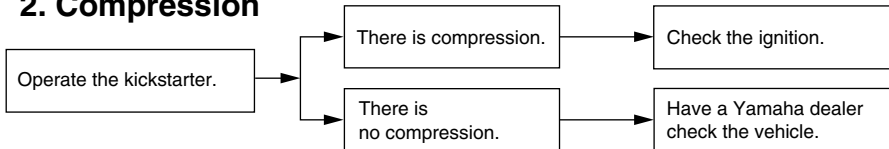

3. Ignition

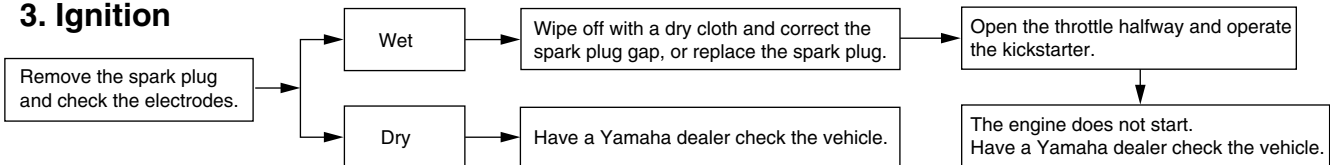

PERIODIC MAINTENANCE AND MINOR REPAIR

Engine overheating

EWAT1040

WARNING

- Do not remove the radiator cap when the engine and radiator are hot. Scalding hot fluid and steam may be blown out under pressure, which could cause serious injury. Be sure to wait until the engine has cooled.
- Place a thick rag, like a towel, over the radiator cap, and then slowly rotate the cap counterclockwise to the detent to allow any residual pressure to escape. When the hissing sound has stopped, press down on the cap while turning it counterclockwise, and then remove the cap.

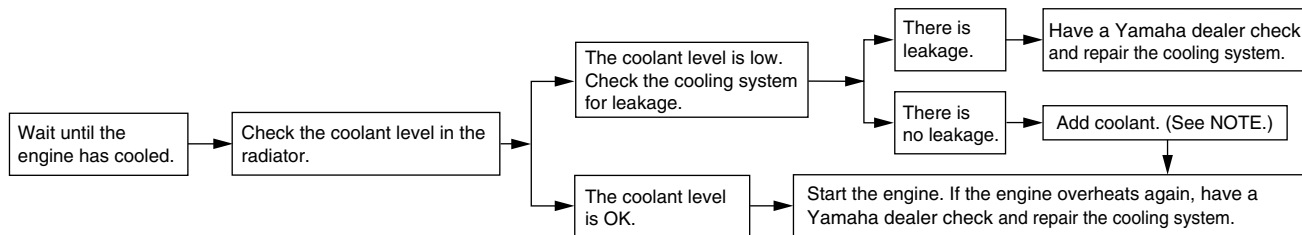

NOTE:

If coolant is not available, tap water can be temporarily used instead, provided that it is changed to the recommended coolant as soon as possible.

MOTORCYCLE CARE AND STORAGE

EAU41351

Care

While the open design of a motorcycle reveals the attractiveness of the technology, it also makes it more vulnerable. Rust and corrosion can develop even if high-quality components are used. A rusty exhaust pipe may go unnoticed on a car, however, it detracts from the overall appearance of a motorcycle. Frequent and proper care does not only comply with the terms of the warranty, but it will also keep your motorcycle looking good, extend its life and optimize its performance.

Before cleaning

1. Cover the muffler outlet with a plastic bag after the engine has cooled down.
2. Make sure that all caps and covers as well as all electrical couplers and connectors, including the spark plug cap, are tightly installed.
3. Remove extremely stubborn dirt, like oil burnt onto the crankcase, with a degreasing agent and a brush, but never apply such prod-

ucts onto seals, gaskets, sprockets, the drive chain and wheel axles. Always rinse the dirt and degreaser off with water.

Cleaning

ECA10770

CAUTION:

- **Avoid using strong acidic wheel cleaners, especially on spoked wheels. If such products are used on hard-to-remove dirt, do not leave the cleaner on the affected area any longer than instructed. Also, thoroughly rinse the area off with water, immediately dry it, and then apply a corrosion protection spray.**
- **Improper cleaning can damage windshields, cowlings, panels and other plastic parts. Use only a soft, clean cloth or sponge with mild detergent and water to clean plastic.**
- **Do not use any harsh chemical products on plastic parts. Be sure to avoid using cloths or sponges which have been in contact with strong or abrasive cleaning products, solvent or thinner, fuel (gasoline), rust removers or inhibitors, brake fluid, antifreeze or electrolyte.**
- **Do not use high-pressure washers or steam-jet cleaners since they cause water seepage and deterioration in the following areas: seals (of wheel and swing-arm bearings, fork and brakes), electric components (couplers, connectors, instruments, switches and lights), breather hoses and vents.**
- **For motorcycles equipped with a windshield: Do not use strong cleaners or hard sponges as they will cause dulling or scratching. Some cleaning compounds for plastic may leave scratches on the windshield. Test the product on a small hidden part of the windshield to make sure that it does not leave any marks. If the windshield is scratched, use a quality plastic polishing compound after washing.**

MOTORCYCLE CARE AND STORAGE

After normal use

Remove dirt with warm water, a mild detergent, and a soft, clean sponge, and then rinse thoroughly with clean water. Use a toothbrush or bottlebrush for hard-to-reach areas. Stubborn dirt and insects will come off more easily if the area is covered with a wet cloth for a few minutes before cleaning.

After riding in the rain or near the sea

Since sea salt is extremely corrosive, carry out the following steps after each ride in the rain or near the sea.

1. Clean the motorcycle with cold water and a mild detergent, after the engine has cooled down.

ECA10790

CAUTION: _____

Do not use warm water since it increases the corrosive action of the salt.

2. Apply a corrosion protection spray on all metal, including chrome- and nickel-plated, surfaces to prevent corrosion.

After cleaning

1. Dry the motorcycle with a chamois or an absorbing cloth.
2. Immediately dry the drive chain and lubricate it to prevent it from rusting.
3. Use a chrome polish to shine chrome, aluminum and stainless-steel parts, including the exhaust system. (Even the thermally induced discoloring of stainless-steel exhaust systems can be removed through polishing.)
4. To prevent corrosion, it is recommended to apply a corrosion protection spray on all metal, including chrome- and nickel-plated, surfaces.
5. Use spray oil as a universal cleaner to remove any remaining dirt.
6. Touch up minor paint damage caused by stones, etc.
7. Wax all painted surfaces.
8. Let the motorcycle dry completely before storing or covering it.

EWA11130

! WARNING _____

- **Make sure that there is no oil or wax on the brakes or tires.**

- **If necessary, clean the brake discs and brake linings with a regular brake disc cleaner or acetone, and wash the tires with warm water and a mild detergent. Before riding at higher speeds, test the motorcycle's braking performance and cornering behavior.**

ECA10800

CAUTION: _____

- **Apply spray oil and wax sparingly and make sure to wipe off any excess.**
- **Never apply oil or wax to any rubber and plastic parts, but treat them with a suitable care product.**
- **Avoid using abrasive polishing compounds as they will wear away the paint.**

NOTE: _____

Consult a Yamaha dealer for advice on what products to use.

MOTORCYCLE CARE AND STORAGE

Storage

EAU41511

Short-term

Always store your motorcycle in a cool, dry place and, if necessary, protect it against dust with a porous cover.

ECA10810

CAUTION:

- **Storing the motorcycle in a poorly ventilated room or covering it with a tarp, while it is still wet, will allow water and humidity to seep in and cause rust.**
- **To prevent corrosion, avoid damp cellars, stables (because of the presence of ammonia) and areas where strong chemicals are stored.**

Long-term

Before storing your motorcycle for several months:

1. Follow all the instructions in the “Care” section of this chapter.
2. For motorcycles equipped with a fuel cock that has an “OFF” position: Turn the fuel cock lever to “OFF”.

3. Drain the fuel tank and fuel lines, and the carburetor float chamber by loosening the drain bolt; this will prevent fuel deposits from building up.
4. Perform the following steps to protect the cylinder, piston rings, etc. from corrosion.
 - a. Remove the spark plug cap and spark plug.
 - b. Pour a teaspoonful of engine oil into the spark plug bore.
 - c. Install the spark plug cap onto the spark plug, and then place the spark plug on the cylinder head so that the electrodes are grounded. (This will limit sparking during the next step.)
 - d. Turn the engine over several times with the starter. (This will coat the cylinder wall with oil.)
 - e. Remove the spark plug cap from the spark plug, and then install the spark plug and the spark plug cap.

EWA10950

! WARNING

To prevent damage or injury from sparking, make sure to ground the spark plug electrodes while turning the engine over.

5. Lubricate all control cables and the pivoting points of all levers and pedals.
6. Check and, if necessary, correct the tire air pressure, and then lift the motorcycle so that both of its wheels are off the ground. Alternatively, turn the wheels a little every month in order to prevent the tires from becoming degraded in one spot.
7. Cover the muffler outlet with a plastic bag to prevent moisture from entering it.

NOTE:

Make any necessary repairs before storing the motorcycle.

Dimensions:

Overall length:

YZ85 1818 mm (71.6 in)
(AUT)(BEL)(CHE)(DEU)(DNK)(ESP)(FIN)(
FRA)(GBR)(GRC)(IRL)(NLD)(NOR)(PRT)(
SWE)
YZ85 1821 mm (71.7 in) (ZAF)
YZ85LW 1903 mm (74.9 in)
YZ85LWW 1903 mm (74.9 in)
YZ85W 1818 mm (71.6 in)
YZ85W1 1818 mm (71.6 in)

Overall width:

758 mm (29.8 in)

Overall height:

YZ85 1161 mm (45.7 in)
YZ85LW 1205 mm (47.4 in)
YZ85LWW 1205 mm (47.4 in)
YZ85W 1161 mm (45.7 in)
YZ85W1 1161 mm (45.7 in)

Seat height:

YZ85 864 mm (34.0 in)
YZ85LW 904 mm (35.6 in)
YZ85LWW 904 mm (35.6 in)
YZ85W 864 mm (34.0 in)
YZ85W1 864 mm (34.0 in)

Wheelbase:

YZ85 1255 mm (49.4 in)
(AUT)(BEL)(CHE)(DEU)(DNK)(ESP)(FIN)(
FRA)(GBR)(GRC)(IRL)(NLD)(NOR)(PRT)(
SWE)
YZ85 1258 mm (49.5 in) (ZAF)
YZ85LW 1286 mm (50.6 in)

YZ85LWW 1286 mm (50.6 in)
YZ85W 1255 mm (49.4 in)
YZ85W1 1255 mm (49.4 in)
Ground clearance:
YZ85 351 mm (13.82 in)
YZ85LW 393 mm (15.47 in)
YZ85LWW 393 mm (15.47 in)
YZ85W 351 mm (13.82 in)
YZ85W1 351 mm (13.82 in)

Weight:

With oil and fuel:

YZ85 71.0 kg (157 lb)
YZ85LW 73.9 kg (163 lb)
YZ85LWW 73.9 kg (163 lb)
YZ85W 71.0 kg (157 lb)
YZ85W1 71.0 kg (157 lb)

Engine:

Engine type:

Liquid cooled 2-stroke

Cylinder arrangement:

Forward-inclined single cylinder

Displacement:

84.7 cm³ (5.17 cu.in)

Bore × stroke:

47.5 × 47.8 mm (1.87 × 1.88 in)

Compression ratio:

8.20 :1

Starting system:

Kickstarter

Lubrication system:

Premix

Engine oil:

Type:

YAMALUBE 2-R

Transmission oil:

Type:

YAMALUBE 4 (10W30) or SAE10W30 type
SE motor oil

Oil change quantity:

0.50 L (0.53 US qt) (0.44 Imp.qt)

Cooling system:

Radiator capacity (including all routes):

0.54 L (0.57 US qt) (0.48 Imp.qt)

Air filter:

Air filter element:

Wet element

Fuel:

Recommended fuel:

Premium unleaded gasoline only

Fuel tank capacity:

5.0 L (1.32 US gal) (1.10 Imp.gal)

Carburetor:

Manufacturer:

KEIHIN

Type × quantity:

PWK28 x 1

Spark plug (s):

Manufacturer/model:

NGK/BR10EG

Spark plug gap:

0.5–0.6 mm (0.020–0.024 in)

Clutch:

Clutch type:

Wet, multiple-disc

Transmission:

Primary reduction system:

Spur gear

SPECIFICATIONS

Primary reduction ratio:

65/18 (3.611)

Secondary reduction system:

Chain drive

Secondary reduction ratio:

YZ85 47/14 (3.357) (ZAF)

YZ85 48/14 (3.428)

(AUT)(BEL)(CHE)(DEU)(DNK)(ESP)(FIN)(
FRA)(GBR)(GRG)(IRL)(NLD)(NOR)(PRT)(
SWE)

YZ85LW 52/14 (3.714)

YZ85LWW 52/14 (3.714)

YZ85W 47/14 (3.357)

YZ85W1 48/14 (3.428)

Transmission type:

Constant mesh 6-speed

Operation:

Left foot operation

Gear ratio:

1st:

27/11 (2.454)

2nd:

32/17 (1.882)

3rd:

26/17 (1.529)

4th:

22/17 (1.294)

5th:

26/23 (1.130)

6th:

25/25 (1.000)

Chassis:

Frame type:

Semi double cradle

Caster angle:

YZ85 26.30 °

YZ85LW 26.90 °

YZ85LWW 26.90 °

YZ85W 26.30 °

YZ85W1 26.30 °

Trail:

YZ85 88.0 mm (3.46 in)

YZ85LW 105.5 mm (4.15 in)

YZ85LWW 105.5 mm (4.15 in)

YZ85W 88.0 mm (3.46 in)

YZ85W1 88.0 mm (3.46 in)

Front tire:

Type:

With tube

Size:

YZ85 70/100-17 40M

YZ85LW 70/100-19 42M

YZ85LWW 70/100-19 42M

YZ85W 70/100-17 40M

YZ85W1 70/100-17 40M

Manufacturer/model:

YZ85 DUNLOP/D739FA (ZAF)

YZ85 DUNLOP/D756F

(AUT)(BEL)(CHE)(DEU)(DNK)(ESP)(FIN)(
FRA)(GBR)(GRG)(IRL)(NLD)(NOR)(PRT)(
SWE)

YZ85LW DUNLOP/D756F

YZ85LWW DUNLOP/D756F

YZ85W DUNLOP/D756F

YZ85W1 DUNLOP/D756F

Rear tire:

Type:

With tube

Size:

YZ85 90/100-14 49M

YZ85LW 90/100-16 52M

YZ85LWW 90/100-16 52M

YZ85W 90/100-14 49M

YZ85W1 90/100-14 49M

Manufacturer/model:

DUNLOP/D756

Tire air pressure (measured on cold tires):

Front:

100 kPa (15 psi) (1.00 kgf/cm²)

Rear:

100 kPa (15 psi) (1.00 kgf/cm²)

Front wheel:

Wheel type:

Spoke wheel

Rim size:

YZ85 17x1.40

YZ85LW 19x1.40

YZ85LWW 19x1.40

YZ85W 17x1.40

YZ85W1 17x1.40

Rear wheel:

Wheel type:

Spoke wheel

Rim size:

YZ85 14x1.60

YZ85LW 16x1.85

YZ85LWW 16x1.85

YZ85W 14x1.60

YZ85W1 14x1.60

Front brake:

- Type:
 - Single disc brake
- Operation:
 - Right hand operation
- Recommended fluid:
 - DOT 4

Rear brake:

- Type:
 - Single disc brake
- Operation:
 - Right foot operation
- Recommended fluid:
 - DOT 4

Front suspension:

- Type:
 - Telescopic fork
- Spring/shock absorber type:
 - Coil spring/oil damper
- Wheel travel:
 - 275.0 mm (10.83 in)

Rear suspension:

- Type:
 - Swingarm (link suspension)
- Spring/shock absorber type:
 - Coil spring/gas-oil damper
- Wheel travel:
 - YZ85 282.0 mm (11.10 in)
 - YZ85LW 287.0 mm (11.30 in)
 - YZ85LWW 287.0 mm (11.30 in)
 - YZ85W 282.0 mm (11.10 in)
 - YZ85W1 282.0 mm (11.10 in)

Electrical system:

- Ignition system:
 - CDI

CONSUMER INFORMATION

EAU40790

Identification numbers

Record the vehicle identification number and model label information in the spaces provided below for assistance when ordering spare parts from a Yamaha dealer or for reference in case the vehicle is stolen.

VEHICLE IDENTIFICATION
NUMBER:

MODEL LABEL INFORMATION:

EAU26400

Vehicle identification number

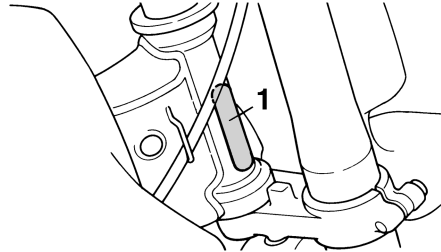

1. Vehicle identification number

The vehicle identification number is stamped into the steering head pipe. Record this number in the space provided.

NOTE: _____

The vehicle identification number is used to identify your motorcycle and may be used to register your motorcycle with the licensing authority in your area.

EAU26460

Model label

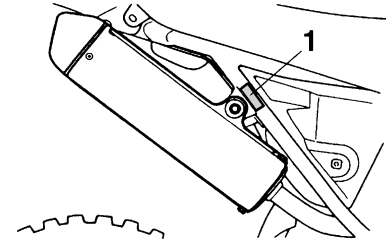

1. Model label

The model label is affixed to the location shown. Record the information on this label in the space provided. This information will be needed when ordering spare parts from a Yamaha dealer.

- A**
 Accessories and replacement parts 6-17
 Air filter element, cleaning 6-12
- B**
 Brake and clutch levers, checking
 and lubricating 6-23
 Brake and shift pedals, checking
 and lubricating 6-23
 Brake fluid, changing 6-20
 Brake fluid level, checking 6-19
 Brake lever 3-2
 Brake pedal 3-2
- C**
 Cables, checking and lubricating 6-22
 Carburetor, adjusting 6-14
 Care 7-1
 Clutch lever 3-1
 Clutch lever free play, adjusting 6-17
 Coolant 6-10
- D**
 Drive chain, cleaning and lubricating 6-21
 Drive chain slack 6-20
- E**
 Engine break-in 5-3
 Engine, starting a warm 5-1
 Engine stop button 3-1
- F**
 Front and rear brake pads, checking 6-18
 Front fork, adjusting 3-7
 Front fork, bleeding 3-8
 Front fork, checking 6-24
 Fuel 3-3
 Fuel cock 3-5
 Fuel tank breather hose 3-5
 Fuel tank cap 3-3
- H**
 Handlebar switch 3-1
- I**
 Identification numbers 9-1
- K**
 Kickstarter 3-6
- L**
 Labels, location of 1-4
- M**
 Model label 9-1
- P**
 Parking 5-4
 Part locations 2-1
 Periodic maintenance and lubrication
 chart 6-2
 Pre-operation check list 4-2
- R**
 Rear suspension, lubricating 6-24
- S**
 Safety information 1-1
 Seat 3-6
 Shifting 5-2
 Shift pedal 3-1
 Shock absorber assembly, adjusting 3-9
 Sidestand 3-12
 Spark plug, checking 6-8
 Specifications 8-1
 Starter (choke) knob 3-6
 Starting and warming up a cold
 engine 5-1
 Steering, checking 6-25
 Storage 7-3
 Supporting the motorcycle 6-26
 Swingarm pivots, lubricating 6-24
- T**
 Throttle cable free play, adjusting 6-14
 Throttle grip and cable, checking
 and lubricating 6-22
 Tires 6-15
 Transmission oil 6-9
 Troubleshooting 6-29
 Troubleshooting charts 6-30
- V**
 Vehicle identification number 9-1
- W**
 Wheel bearings, checking 6-26
 Wheel (front) 6-27
 Wheel (rear) 6-27
 Wheels 6-17



PRINTED ON RECYCLED PAPER

PRINTED IN JAPAN
2006.04-1.4×1 CR
(E)