



OWNER'S MANUAL

**TDR**

**TDR125**

5AE-28199-E3



Welcome to the Yamaha world of motorcycling!

As the owner of a TDR125, you are benefiting from Yamaha's vast experience in and newest technology for the design and the manufacture of high-quality products, which have earned Yamaha a reputation for dependability.

Please take the time to read this manual thoroughly, so as to enjoy all your TDR125's advantages. The owner's manual does not only instruct you in how to operate, inspect and maintain your motorcycle, but also in how to safeguard yourself and others from trouble and injury.

In addition, the many tips given in this manual will help to keep your motorcycle in the best possible condition. If you have any further questions, do not hesitate to contact your Yamaha dealer.

The Yamaha team wishes you many safe and pleasant rides. So, remember to put safety first!

# IMPORTANT MANUAL INFORMATION

---

Particularly important information is distinguished in this manual by the following notations:



The Safety Alert Symbol means **ATTENTION! BECOME ALERT! YOUR SAFETY IS INVOLVED!**

## **WARNING**

Failure to follow **WARNING** instructions could result in severe injury or death to the motorcycle operator, a bystander or a person inspecting or repairing the motorcycle.

## **CAUTION:**

A **CAUTION** indicates special precautions that must be taken to avoid damage to the motorcycle.

## **NOTE:**

A **NOTE** provides key information to make procedures easier or clearer.

## **NOTE:**

- This manual should be considered a permanent part of this motorcycle and should remain with it even if the motorcycle is subsequently sold.
  - Yamaha continually seeks advancements in product design and quality. Therefore, while this manual contains the most current product information available at the time of printing, there may be minor discrepancies between your motorcycle and this manual. If there is any question concerning this manual, please consult your Yamaha dealer.
-

# IMPORTANT MANUAL INFORMATION

---

---

EW000002

## **⚠ WARNING**

---

**PLEASE READ THIS MANUAL CAREFULLY AND COMPLETELY BEFORE OPERATING THIS MOTORCYCLE.**

---

---

---

EAU00008

**TDR125**

**OWNER'S MANUAL**

**©1999 by Yamaha Motor Co., Ltd.**

**1st Edition, August 1999**

**All rights reserved. Any reprinting or  
unauthorized use without the written  
permission of Yamaha Motor Co., Ltd.  
is expressly prohibited.**

**Printed in Japan**

1 GIVE SAFETY THE RIGHT OF WAY

1

2 DESCRIPTION

2

3 INSTRUMENT AND CONTROL FUNCTIONS

3

4 PRE-OPERATION CHECKS

4

5 OPERATION AND IMPORTANT RIDING POINTS

5

6 PERIODIC MAINTENANCE AND MINOR REPAIR

6

7 MOTORCYCLE CARE AND STORAGE

7

8 SPECIFICATIONS

8

9 CONSUMER INFORMATION

9

INDEX







GIVE SAFETY THE RIGHT OF WAY .....1-1



# GIVE SAFETY THE RIGHT OF WAY

---

Motorcycles are fascinating vehicles, which can give you an unsurpassed feeling of power and freedom. However, they also impose certain limits, which you must accept; even the best motorcycle does not ignore the laws of physics.

Regular care and maintenance are essential for preserving your motorcycle's value and operating condition. Moreover, what is true for the motorcycle is also true for the rider: good performance depends on being in good shape. Riding under the influence of medication, drugs and alcohol is, of course, out of the question. Motorcycle riders more than car drivers must always be at their mental and physical best. Under the influence of even small amounts of alcohol, there is a tendency to take dangerous risks.

Protective clothing is as essential for the motorcycle rider as seat belts are for car drivers and passengers. Always wear a complete motorcycle suit (whether made of leather or tear-resistant synthetic materials with protectors), sturdy boots, motorcycle gloves and a properly fitting helmet. Optimum protective wear, however, should not encourage carelessness. Though full-coverage helmets and suits, in particular, create an illusion of total safety and protection, motorcyclists will always be vulnerable. Riders who lack critical self-control run the risk of going too fast and are apt to take chances. This is even more dangerous in wet weather. The good motorcyclist rides safely, predictably and defensively avoiding all dangers, including those caused by others.

Enjoy your ride!

Left view .....	2-1
Right view .....	2-2
Controls/Instruments .....	2-3

# DESCRIPTION

## Left view

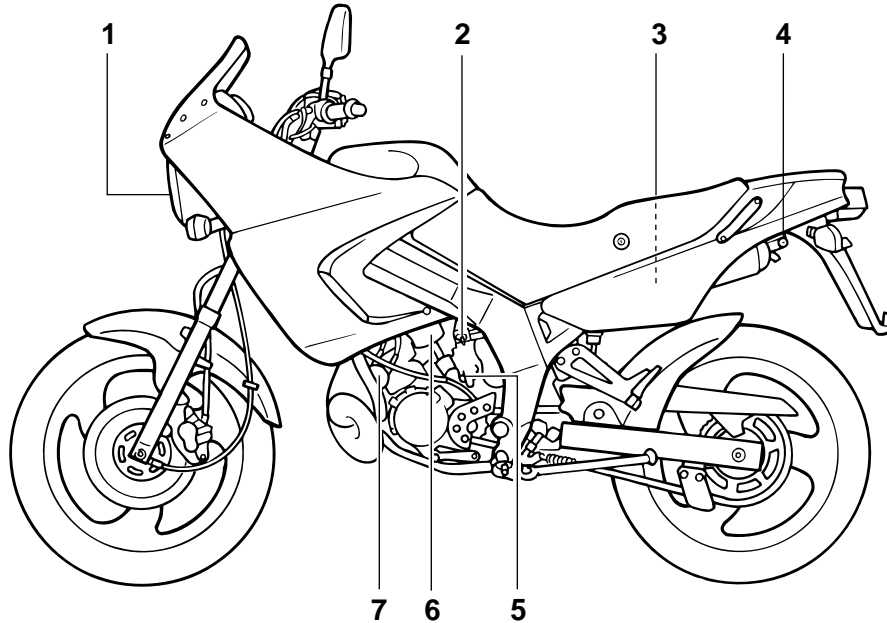

1. Dual headlight
2. Fuel cock
3. Engine oil tank
4. Helmet holder
5. Starter "⌚"

(page 3-6)

(page 3-12)

(page 3-12)

(page 3-12)

(page 3-13)

6. Y.E.I.S.

7. Y.P.V.S.

(page 3-15)

(page 3-16)

## Right view

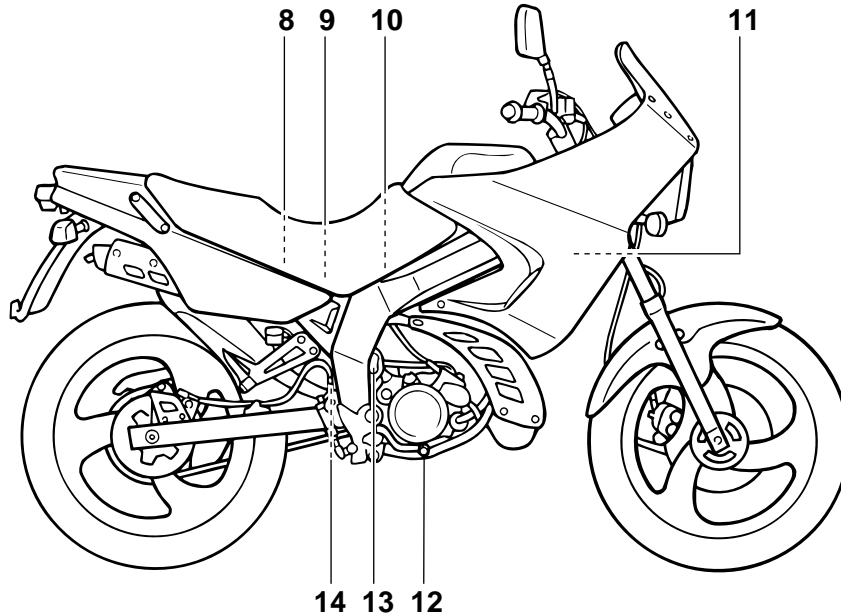

- |                            |                  |                                                          |             |
|----------------------------|------------------|----------------------------------------------------------|-------------|
| 8. Tool kit                | (page 6-1)       | 14. Rear shock absorber spring<br>preload adjusting ring | (page 3-14) |
| 9. Fuse                    | (page 6-32)      |                                                          |             |
| 10. Air filter             | (page 6-15)      |                                                          |             |
| 11. Radiator cap           | (page 6-11)      |                                                          |             |
| 12. Rear brake pedal       | (page 3-9, 6-22) |                                                          |             |
| 13. Coolant reservoir tank | (page 6-10)      |                                                          |             |

# DESCRIPTION

---

## Controls/Instruments

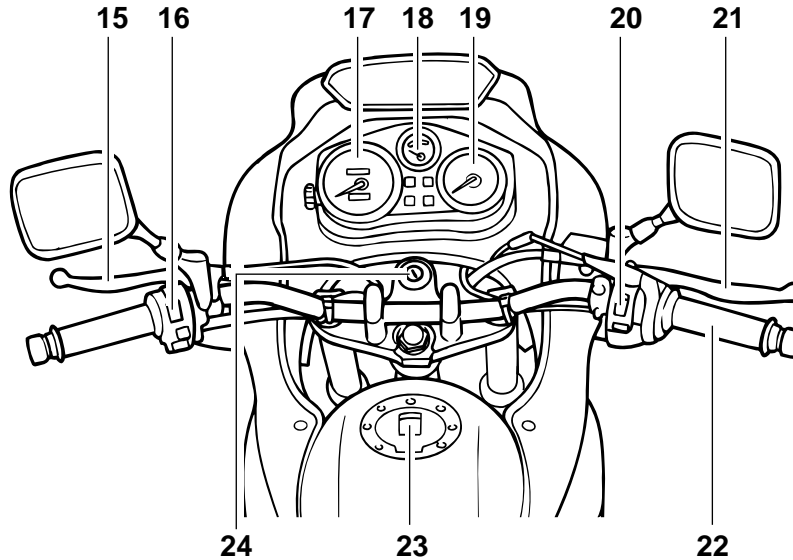

- |                              |                  |                               |                  |
|------------------------------|------------------|-------------------------------|------------------|
| 15. Clutch lever             | (page 3-8, 6-20) | 20. Right handlebar switches  | (page 3-6)       |
| 16. Left handlebar switches  | (page 3-5)       | 21. Front brake lever         | (page 3-9, 6-21) |
| 17. Speedometer              | (page 3-4)       | 22. Throttle grip             | (page 6-17)      |
| 18. Engine temperature gauge | (page 3-5)       | 23. Fuel tank cap             | (page 3-9)       |
| 19. Tachometer               | (page 3-5)       | 24. Main switch/Steering lock | (page 3-1)       |

# INSTRUMENT AND CONTROL FUNCTIONS

Main switch/steering lock.....	3-1	Y.P.V.S. (Yamaha Power Valve System) .....	3-16
Indicator lights .....	3-2	Sidestand.....	3-16
Oil level indicator circuit check .....	3-3	Sidestand/clutch switch operation check.....	3-17
Speedometer .....	3-4		
Tachometer .....	3-4		
Engine temperature gauge.....	3-5		
Handlebar switches .....	3-5		
Headlight beam variation.....	3-6		
Clutch lever.....	3-8		
Shift pedal.....	3-8		
Front brake lever .....	3-8		
Rear brake pedal .....	3-9		
Fuel tank cap .....	3-9		
Fuel.....	3-10		
Catalyzer (for Switzerland and Austria).....	3-11		
Two-stroke engine oil .....	3-12		
Fuel cock .....	3-12		
Starter (choke) “ ↘ ” .....	3-13		
Seat .....	3-13		
Helmet holder .....	3-14		
Rear shock absorber adjustment.....	3-14		
Note on handling of the Yamaha Energy Induction System (Y.E.I.S.) .....	3-15		

# INSTRUMENT AND CONTROL FUNCTIONS

EAU00016

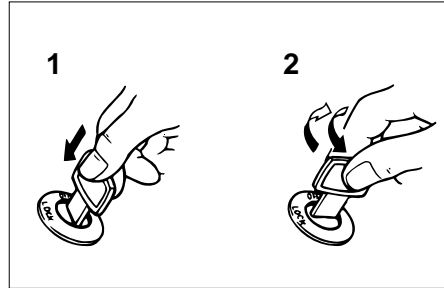
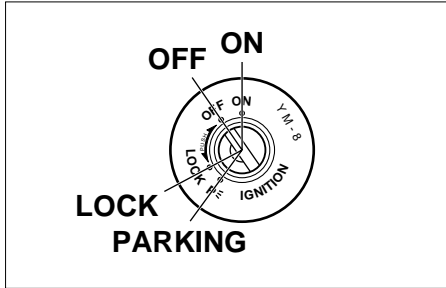

1. Push

2. Turn

EAU00029

EAU00042

## Main switch/Steering lock

The main switch controls the ignition and lighting systems. Its operation is described below.

EAU00036

### ON

Electrical circuits are switched on. The engine can be started. The key cannot be removed in this position.

EAU00038

### OFF

All electrical circuits are switched off. The key can be removed in this position.

## LOCK

The steering is locked in this position and all electrical circuits are switched off.

The key can be removed in this position.

To lock the steering, turn the handlebars all the way to the left. With the key at "OFF", push it into the main switch and release it, turn it counter-clockwise to "LOCK" and remove it.

To release the lock, turn the key to "OFF".

## ⚠ WARNING

Never turn the key to "OFF" or "LOCK" when the motorcycle is moving. The electrical circuits will be switched off which may result in loss of control or an accident. Be sure the motorcycle is stopped before turning the key to "OFF" or "LOCK".

EAU00048\*

## P (Parking)

The steering is locked in this position, and the taillight and auxiliary light come on but all other circuits are off. The key can be removed in this position.

To use the parking position, first lock the steering, then turn the key to "P". Do not use this position for an extended length of time as the battery may discharge.



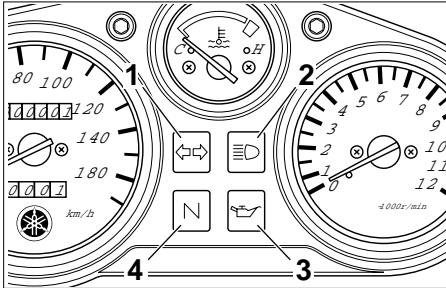

1. Turn indicator light “↔”
2. High beam indicator light “≡D”
3. Neutral indicator light “N”
4. Oil level indicator light “🛢️”

EAU00056

## Indicator lights

EAU00057

### Turn indicator light “↔”

This indicator flashes when the turn switch is moved to the left or right.

EAU00061

### Neutral indicator light “N”

This indicator comes on when the transmission is in neutral.

EAU00063

### High beam indicator light “≡D”

This indicator comes on when the headlight high beam is used.

EAU01313

### Oil level indicator light “🛢️”

This indicator comes on when the oil level is low. This light circuit can be checked by the procedure on page 3-3.

EC000000

## CAUTION:

**Do not run the motorcycle until you know it has sufficient engine oil.**

## NOTE:

Even if the oil is filled to the specified level, the indicator light may flicker when riding on a slope or during sudden acceleration or deceleration, but this is normal.

# INSTRUMENT AND CONTROL FUNCTIONS

EAU00071

## Oil level indicator circuit check

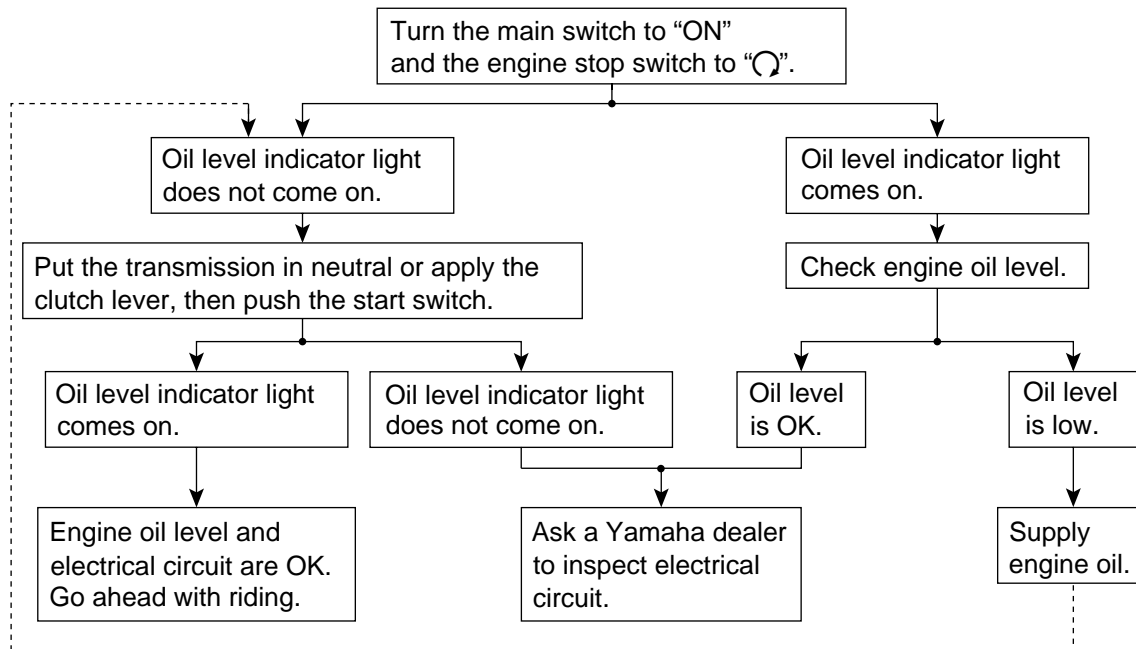

# INSTRUMENT AND CONTROL FUNCTIONS

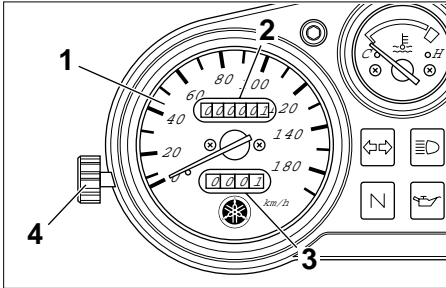

1. Speedometer
2. Odometer
3. Trip odometer
4. Reset knob

EAU01087

## Speedometer

The speedometer shows riding speed. This speedometer is equipped with an odometer and trip odometer. The trip odometer can be reset to "0" with the reset knob. Use the trip odometer to estimate how far you can ride on a tank of fuel. This information will enable you to plan fuel stops in the future.

**NOTE:** \_\_\_\_\_  
(for German model equipped with speed limiter only)  
This motorcycle is equipped with a speed limiter which prevents it from exceeding a top speed of 80 km/h.

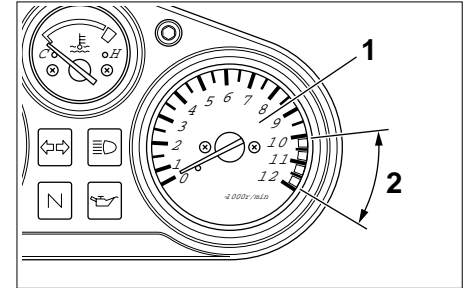

1. Tachometer
2. Red zone

EAU00102

## Tachometer

This model is equipped with a tachometer so the rider can monitor the engine speed and keep it within the ideal power range.

EC000003

## CAUTION:

**Do not operate in the red zone.  
Red zone: 10,000 r/min and above**

# INSTRUMENT AND CONTROL FUNCTIONS

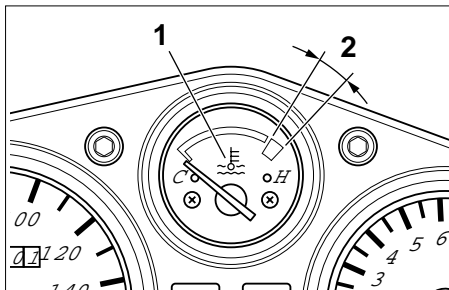

1. Engine temperature gauge
2. Red zone

EAU00114

## Engine temperature gauge

This gauge indicates the coolant temperature when the main switch is on. The engine operating temperature will vary with changes in weather and engine load. If the needle points to the red zone or higher, stop your motorcycle and let the engine cool. (See page 6-10 for details.)

EC000002

### CAUTION:

**When the engine is overheated, do not continue riding.**

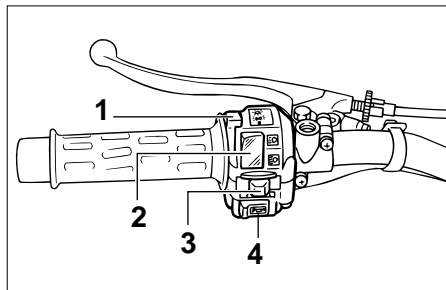



1. Lights switch
2. Dimmer switch
3. Turn signal switch
4. Horn switch “”

EAU00118

## Handlebar switches



EAU00134

### Lights switch

Turning the light switch to “”, turns on the auxiliary light, meter lights and taillight. Turning the light switch to “”, turns the headlight on also.



EAU00121

### Dimmer switch

Turn the switch to “” for the high beam and to “” for the low beam.

EAU00127

### Turn signal switch

To signal a right-hand turn, push the switch to “”. To signal a left-hand turn, push the switch to “”. Once the switch is released it will return to the center position. To cancel the signal, push the switch in after it has returned to the center position.

EAU00129

### Horn switch “”

Press the switch to sound the horn.

# INSTRUMENT AND CONTROL FUNCTIONS

EAU00136

## Headlight beam variation

☀ : High beam light on ,

☀ : Low beam light on

☸☸ : Auxiliary light on

		Left	Right	Bulb to be used		Destination
1		☀	☸☸	Halogen bulb		France Sweden Portugal Spain Greece Belgium Germany Switzerland Finland Austria
		☸☸	☀			
2		☀	☀	Halogen bulb		England Ireland
		☀	☀			

### NOTE:

Right and left directions are those assumed from the position of a person facing the front of the motorcycle.

# INSTRUMENT AND CONTROL FUNCTIONS

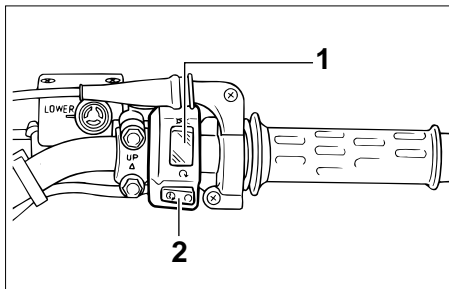

1. Engine stop switch
2. Start switch “⚡”

EAU00138

## Engine stop switch

The engine stop switch is a safety device for use in an emergency such as when the motorcycle overturns or if trouble occurs in the throttle system. Turn the switch to “⚡” to start the engine.

In case of emergency, turn the switch to “⚡” to stop the engine.

EAU00143

## Start switch “⚡”

The starter motor cranks the engine when pushing the start switch.

EC000005

## CAUTION:

**See starting instructions prior to starting the engine.**

# INSTRUMENT AND CONTROL FUNCTIONS

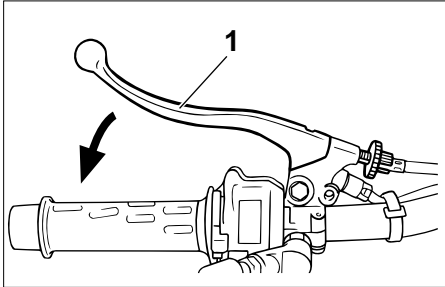

1. Clutch lever

EAU00152

## Clutch lever

The clutch lever is located on the left handlebar, and the ignition circuit cut-off system is incorporated in the clutch lever holder. Pull the clutch lever to the handlebar to disengage the clutch, and release the lever to engage the clutch. The lever should be pulled rapidly and released slowly for smooth clutch operation. (Refer to the engine starting procedures for a description of the ignition circuit cut-off system.)

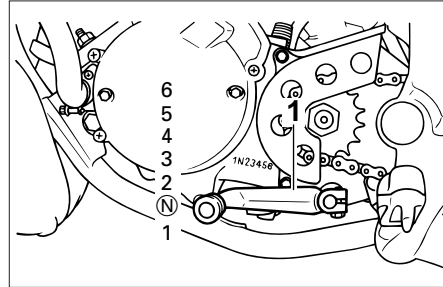

1. Shift pedal  
N. Neutral

EAU00157

## Shift pedal

This motorcycle is equipped with a constant-mesh 6-speed transmission. The shift pedal is located on the left side of the engine and is used in combination with the clutch when shifting.

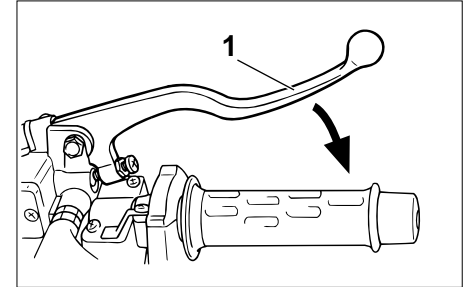

1. Front brake lever

EAU00158

## Front brake lever

The front brake lever is located on the right handlebar. Pull it toward the handlebar to apply the front brake.

# INSTRUMENT AND CONTROL FUNCTIONS

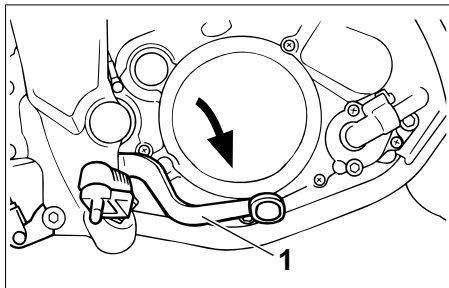

1. Rear brake pedal

EAU00162

## Rear brake pedal

The rear brake pedal is on the right side of the motorcycle. Press down on the brake pedal to apply the rear brake.

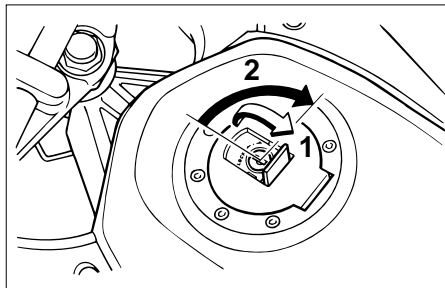

1. Open
2. Unlock

EAU02935

## Fuel tank cap

### To open

Open the lock cover. Insert the key and turn it 1/4 turn clockwise. The lock will be released and the cap can be opened.

### To close

Push the tank cap into position with the key inserted. To remove the key, turn it counterclockwise to the original position. Then, close the lock cover.

### NOTE:

This tank cap cannot be closed unless the key is in the lock. The key cannot be removed if the cap is not locked properly.

EW000023

### **WARNING**

**Be sure the cap is properly installed and locked in place before riding the motorcycle.**



# INSTRUMENT AND CONTROL FUNCTIONS

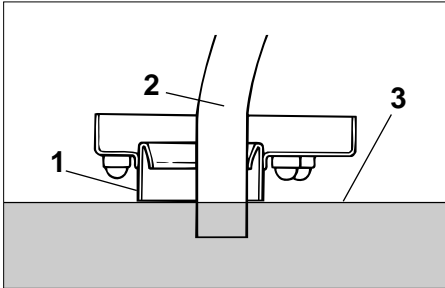

1. Filler tube
2. Filling nozzle
3. Fuel level

EAU01183

## Fuel (except for Switzerland and Austria)

Make sure there is sufficient fuel in the tank. Fill the fuel tank to the bottom of the filler tube as shown in the illustration.

EW000130

### **⚠ WARNING**

Do not overfill the fuel tank. Avoid spilling fuel on the hot engine. Do not fill the fuel tank above the bottom of the filler tube or it may overflow when the fuel heats up later and expands.

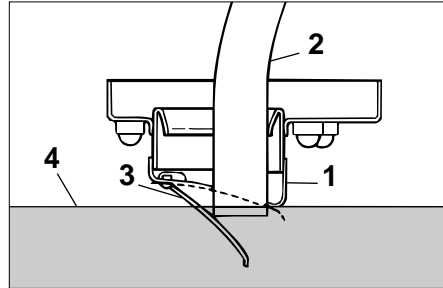

1. Filler tube
2. Filling nozzle
3. Leaf valve
4. Fuel level

EAU01184\*

## (for Switzerland and Austria)

Make sure there is sufficient fuel in the tank. When refueling, be sure to insert the filling nozzle into the filler hole and fill the tank to the bottom of the filler tube as shown in the illustration.

EW000130

### **⚠ WARNING**

Do not overfill the fuel tank. Avoid spilling fuel on the hot engine. Do not fill the fuel tank above the bottom of the filler tube or it may overflow when the fuel heats up later and expands.

EAU00185

### **CAUTION:**

Always wipe off spilled fuel immediately with a dry and clean soft cloth. Fuel may deteriorate painted surfaces or plastic parts.

EAU00191

Recommended fuel:  
Regular unleaded gasoline  
with a research octane  
number of 91 or higher.

Fuel tank capacity:

Total:

11.0 L

Reserve:

2.2 L

**NOTE:** \_\_\_\_\_  
If knocking or pinging occurs, use a  
different brand of gasoline or higher  
octane grade.

---

EAU01084

## Catalyzer (for Switzerland and Austria)

This motorcycle is equipped with a  
catalytic converter in the exhaust  
chamber.

### **⚠ WARNING** \_\_\_\_\_

**The exhaust system is hot during  
and directly after engine operation.  
Make sure the exhaust system has  
cooled down before making any  
adjustment to or lubricating the  
motorcycle.**

---

EW000128

EC000114

### **CAUTION:** \_\_\_\_\_

**The following must be observed to  
prevent a fire hazard or other dam-  
ages.**

- **Use only unleaded gasoline.  
Use of leaded gasoline will  
cause unreparable damage to  
the catalytic converter.**
  - **Never park this motorcycle in  
an area that would cause a fire  
hazard such as grass or other  
materials that may easily burn.**
  - **Do not allow the engine to idle  
for very long.**
-

# INSTRUMENT AND CONTROL FUNCTIONS

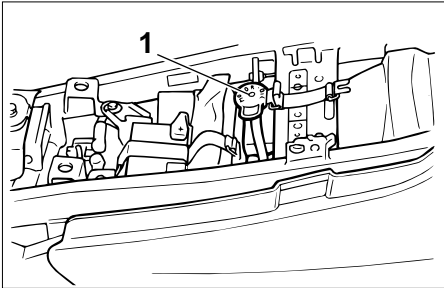

1. Filler cap

EAU02956

## Two-stroke engine oil

Make sure the two-stroke engine oil is at the specified level. Fill with oil as necessary.

Recommended oil:

Yamalube 2 or 2-stroke engine oil (JASO FC grade or ISO EG-C, EG-D grade)

Oil quantity:

1.2 L

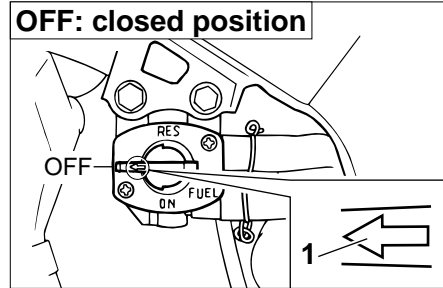

1. Arrow mark pointing to "OFF"

EAU03050

## Fuel cock

The fuel cock supplies fuel from the tank to the carburetor while filtering it also.

The fuel cock has three positions:

### OFF

With the lever in this position, fuel will not flow. Always return the lever to this position when the engine is not running.

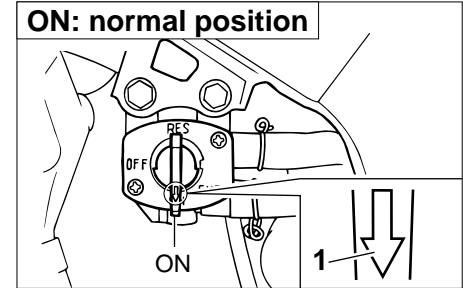

1. Arrow mark pointing to "ON"

### ON

With the lever in this position, fuel flows to the carburetor. Normal riding is done with the lever in this position.

# INSTRUMENT AND CONTROL FUNCTIONS

**RES: reserve position**

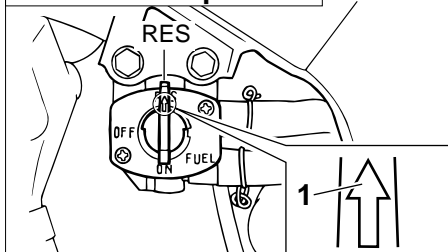

1. Arrow mark pointing to “RES”

## RES

This indicates reserve. If you run out of fuel while riding, move the lever to this position. Fill the tank at the first opportunity. Be sure to set the lever back to “ON” after refueling!

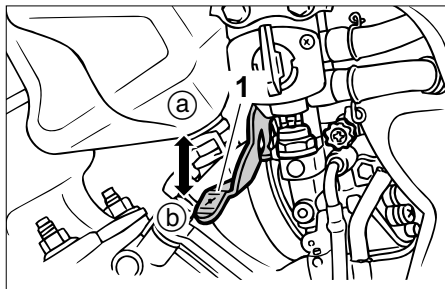

1. Starter(choke) “|↘|”

EAU02976

## Starter (choke) “|↘|”

Starting a cold engine requires a richer air-fuel mixture. A separate starter circuit supplies this mixture.

Move in direction ① to turn on the starter (choke).

Move in direction ② to turn off the starter (choke).

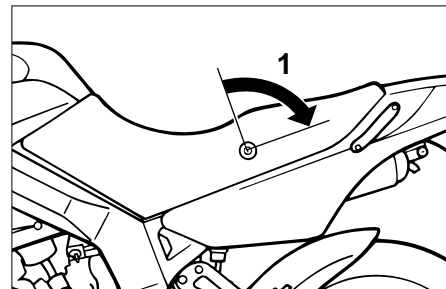

1. Unlock

EAU01619

## Seat

### To remove

Insert the key into the lock and turn it clockwise.

# INSTRUMENT AND CONTROL FUNCTIONS

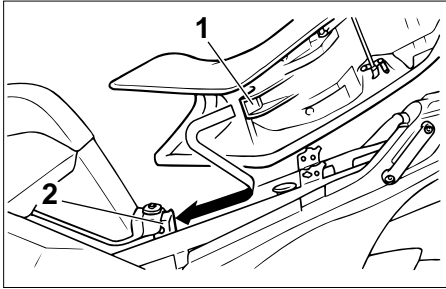

1. Projection
2. Seat holder

## To install

Insert the projection on the front of the seat into the seat holder. Push down on the seat and remove the key.

## NOTE:

Make sure that the seat is securely fitted.

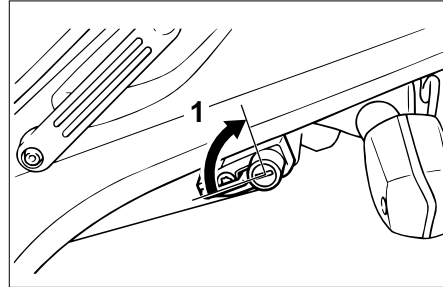

1. Open

## Helmet holder

To open the helmet holder, insert the key in the lock and turn it as shown. To lock the helmet holder, replace the holder in its original position.

EAU00260

EW000030

## **⚠ WARNING**

**Never ride with a helmet in the helmet holder. The helmet may hit objects, causing loss of control and possibly an accident.**

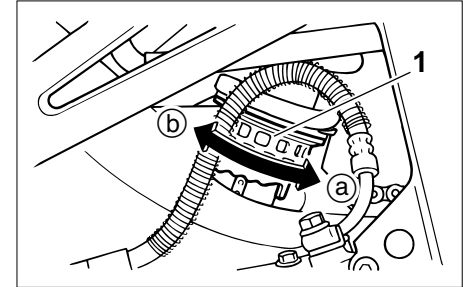

1. Adjusting ring

## Rear shock absorber adjustment

This shock absorber is equipped with a spring preload adjusting ring. Adjust spring preload as follows.

Turn the adjusting ring in direction (a) to increase spring preload and in direction (b) to decrease spring preload.

Make sure that the appropriate notch in the adjusting ring is aligned with the position indicator on the rear shock absorber.

EAU00295

# INSTRUMENT AND CONTROL FUNCTIONS

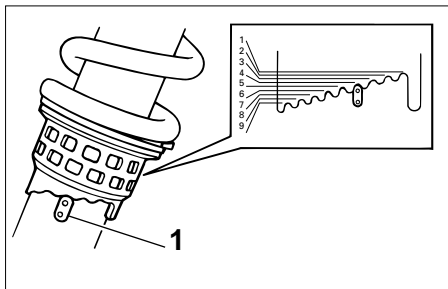

1. Position indicator

	Hard					Stan- dard	Soft		
Adjusting Position	9	8	7	6	5	4	3	2	1

## **⚠ WARNING**

EAU00315

This shock absorber contains highly pressurized nitrogen gas. Read and understand the following information before handling the shock absorber. The manufacturer cannot be held responsible for property damage or personal injury that may result from improper handling.

- Do not tamper with or attempt to open the cylinder assembly.
- Do not subject the shock absorber to an open flame or other high heat source. This may cause the unit to explode due to excessive gas pressure.
- Do not deform or damage the cylinder in any way. Cylinder damage will result in poor damping performance.
- Take your shock absorber to a Yamaha dealer for any service.

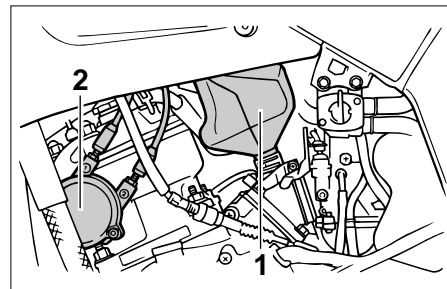

1. Y.E.I.S.
2. Y.P.V.S.

EAU00325

## **Note on handling of the Yamaha Energy Induction System (Y.E.I.S.)**

Handle the air chamber and hose with special care. Improper installation or damaged parts will result in poor performance. Replace any cracked or damaged parts immediately. No modification of this system in any form can be made.

EC000022

## **CAUTION:**

**Never attempt to modify the Yamaha Energy Induction System.**

EAU00326

## Y.P.V.S. (Yamaha Power Valve System)

The Y.P.V.S. is a vital part of the engine and requires very sophisticated adjustment. Adjustment should be left to a Yamaha dealer who has the professional knowledge and experience to do so.

EC000023

### CAUTION:

**The Y.P.V.S. was set at the Yamaha factory after many tests. If the settings are disturbed by someone without sufficient technical knowledge, poor engine performance and damage may result.**

The Y.P.V.S. operation can be heard in the following instances:

- When the main switch is turned on and the engine is started.
- When the engine stalls while the main switch is on.

EC000024

### CAUTION:

**If the Y.P.V.S. does not operate, ask a Yamaha dealer to inspect the vehicle.**

EAU00330

## Sidestand

This model is equipped with an ignition circuit cut-off system. The motorcycle must not be ridden when the sidestand is down. The sidestand is located on the left side of the frame. (Refer to page 5-1 for an explanation of this system.)

# INSTRUMENT AND CONTROL FUNCTIONS

## **⚠ WARNING**

EW000044

This motorcycle must not be operated with the sidestand in the down position. If the stand is not properly retracted, it could contact the ground and distract the operator, resulting in a possible loss of control. Yamaha has designed into this motorcycle a lockout system to assist the operator in fulfilling the responsibility of retracting the sidestand. Please check carefully the operating instructions listed below and if there is any indication of a malfunction, return the motorcycle to a Yamaha dealer immediately for repair.

## **Sidestand/clutch switch operation check**

EAU00031

Check the operation of the sidestand switch and clutch switch against the information below.

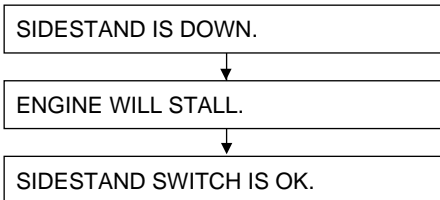
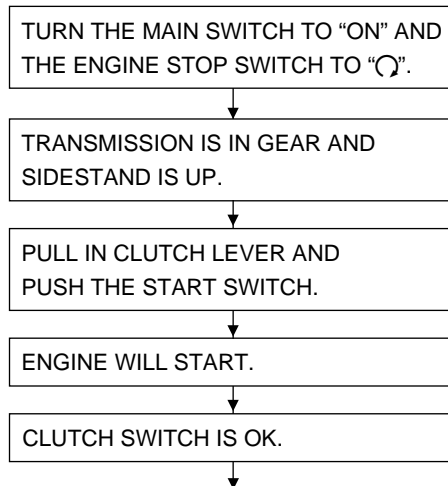

## **⚠ WARNING**

EW000045

If improper operation is noted, consult a Yamaha dealer immediately.



Pre-operation check list .....4-1

# PRE-OPERATION CHECKS

Owners are personally responsible for their vehicle's condition. Your motorcycle/scooter's vital functions can start to deteriorate quickly and unexpectedly, even if it remains unused (for instance, if it is exposed to the elements). Any damage, fluid leak or loss of tire pressure could have serious consequences. Therefore, it is very important that, in addition to a thorough visual inspection, you check the following points before each ride.

## PRE-OPERATION CHECK LIST

ITEM	CHECKS	PAGE
<b>Front brake</b>	<ul style="list-style-type: none"> <li>• Check operation, free play, fluid level and vehicle for fluid leakage.</li> <li>• Fill with DOT 4 (or DOT 3) brake fluid if necessary.</li> </ul>	3-8~3-9, 6-21 ~ 6-24
<b>Rear brake</b>	<ul style="list-style-type: none"> <li>• Check operation, free play, fluid level and vehicle for fluid leakage.</li> <li>• Fill with DOT 4 brake fluid if necessary.</li> </ul>	
<b>Clutch</b>	<ul style="list-style-type: none"> <li>• Check operation, condition and free play.</li> <li>• Adjust if necessary.</li> </ul>	3-8, 6-20 ~ 6-21
<b>Throttle grip and housing</b>	<ul style="list-style-type: none"> <li>• Check for smooth operation.</li> <li>• Lubricate.</li> <li>• Adjust throttle cable free play if necessary.</li> </ul>	6-17 ~ 6-18, 6-27
<b>Engine oil</b>	<ul style="list-style-type: none"> <li>• Check oil level.</li> <li>• Fill with oil if necessary.</li> </ul>	3-12
<b>Transmission oil</b>	<ul style="list-style-type: none"> <li>• Check oil level.</li> <li>• Fill with oil if necessary.</li> </ul>	6-9 ~ 6-10
<b>Coolant</b>	<ul style="list-style-type: none"> <li>• Check coolant level.</li> <li>• Fill with coolant if necessary.</li> </ul>	6-10 ~ 6-11
<b>Drive chain</b>	<ul style="list-style-type: none"> <li>• Check chain slack and condition.</li> <li>• Adjust if necessary.</li> </ul>	6-25 ~ 6-26
<b>Wheels and tires</b>	<ul style="list-style-type: none"> <li>• Check tire pressure, wear, damage.</li> </ul>	6-18 ~ 6-20
<b>Control and meter cable</b>	<ul style="list-style-type: none"> <li>• Check for smooth operation.</li> <li>• Lubricate if necessary.</li> </ul>	6-27

# PRE-OPERATION CHECKS

ITEM	CHECKS	PAGE
Brake and shift pedal shafts	<ul style="list-style-type: none"><li>• Check for smooth operation.</li><li>• Lubricate if necessary.</li></ul>	6-28
Brake and clutch lever pivots	<ul style="list-style-type: none"><li>• Check for smooth operation.</li><li>• Lubricate if necessary.</li></ul>	
Sidestand pivot	<ul style="list-style-type: none"><li>• Check for smooth operation.</li><li>• Lubricate if necessary.</li></ul>	6-28
Chassis fasteners	<ul style="list-style-type: none"><li>• Make sure that all nuts, bolts, and screws are properly tightened.</li><li>• Tighten if necessary.</li></ul>	—
Fuel tank	<ul style="list-style-type: none"><li>• Check fuel level.</li><li>• Fill with fuel if necessary.</li></ul>	3-9 ~ 3-10
Lights, signals and switches	<ul style="list-style-type: none"><li>• Check for proper operation.</li></ul>	6-32 ~ 6-34

## NOTE:

Pre-operation checks should be made each time the motorcycle is used. Such an inspection can be accomplished in a very short time; and the added safety it assures is more than worth the time involved.

## **⚠ WARNING**

If any item in the Pre-Operation Check is not working properly, have it inspected and repaired before operating the motorcycle.



# OPERATION AND IMPORTANT RIDING POINTS

---

Starting the engine .....	5-1
Starting a warm engine.....	5-4
Shifting.....	5-4
Recommended shift points (for Switzerland only) .....	5-5
Tips for reducing fuel consumption.....	5-5
Engine break-in .....	5-5
Parking .....	5-6

# OPERATION AND IMPORTANT RIDING POINTS

---

## **⚠ WARNING**

EAU00373

- Before riding this motorcycle, become thoroughly familiar with all operating controls and their functions. Consult a Yamaha dealer regarding any control or function that you do not thoroughly understand.
- Never start your engine or let it run for any length of time in a closed area. The exhaust fumes are poisonous and can cause loss of consciousness and death within a short time. Always operate your motorcycle in an area with adequate ventilation.
- Before starting out, always be sure the sidestand is up. Failure to retract the sidestand completely can result in a serious accident when you try to turn a corner.

## Starting the engine

EAU00381

### NOTE:

This motorcycle is equipped with an ignition circuit cut-off system. The engine can be started only under the following conditions:

- The transmission is in neutral.
- The sidestand is up, the transmission is in gear and the clutch is disengaged

The motorcycle must not be ridden when the sidestand is down.

## **⚠ WARNING**

EW000054

Before going through the following steps, check the function of the sidestand switch and clutch switch. (Refer to page 3-17.)

# OPERATION AND IMPORTANT RIDING POINTS

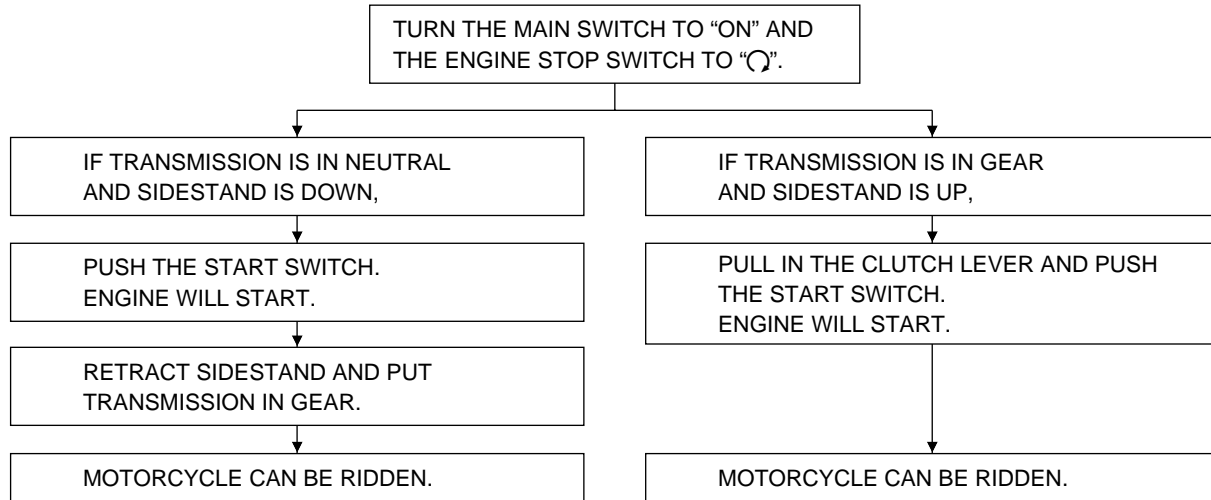

# OPERATION AND IMPORTANT RIDING POINTS

---

1. Turn the fuel cock to “ON”.
2. Turn the main switch to “ON” and the engine stop switch to “

**NOTE:** \_\_\_\_\_  
When the transmission is in neutral, the neutral indicator light should be on. If the light does not come on, ask a Yamaha dealer to inspect it.

---

4. Turn on the starter (choke) and completely close the throttle grip.
5. Start the engine by pushing the start switch.

**NOTE:** \_\_\_\_\_  
If the engine fails to start, release the start switch, wait a few seconds, then try again. Each attempt should be as short as possible to preserve the battery. Do not crank the engine more than 10 seconds on any one attempt.

---

EC000034

**CAUTION:** \_\_\_\_\_

**The oil level indicator light should come on when the start switch is pushed and should go off when the start switch is released. If the indicator light flickers or remains on, immediately stop the engine and check the engine oil level and for oil leakage. If necessary, fill the engine with oil and check to see that the oil level indicator light goes off. If the light does not go off even with sufficient oil in the crankcase or the light does not come on when pushing the start switch, consult a Yamaha dealer.**

---

6. After starting the engine, move the starter (choke) halfway back.

**NOTE:** \_\_\_\_\_  
For maximum engine life, never accelerate hard with a cold engine!

---

7. After the engine is warm, turn off the starter (choke) completely.

**NOTE:** \_\_\_\_\_  
The engine is warm when it responds normally to the throttle with the starter (choke) turned off.

---



## Starting a warm engine

EAU01258

The starter (choke) is not required when the engine is warm.

EC000046

### CAUTION:

See the “Engine break-in” section prior to operating the motorcycle for the first time.

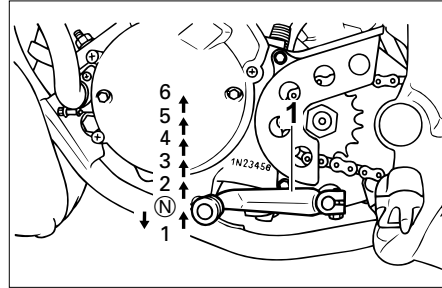

- 1. Shift pedal
- N. Neutral

EAU00423

## Shifting

The transmission lets you control the amount of power you have available at a given speed for starting, accelerating, climbing hills, etc. The use of the shift pedal is shown in the illustration.

To shift into neutral, depress the shift pedal repeatedly until it reaches the end of its travel, then raise the pedal slightly.

EC000048

### CAUTION:

- Do not coast for long periods with the engine off, and do not tow the motorcycle a long distance. Even with gears in neutral, the transmission is only properly lubricated when the engine is running. Inadequate lubrication may damage the transmission.
- Always use the clutch when changing gears. The engine, transmission, and driveline are not designed to withstand the shock of forced shifting and can be damaged by shifting without using the clutch.

## Recommended shift points (for Switzerland only)

The recommended shift points are shown in the table below.

	Acceleration shift point km/h
1st → 2nd	20
2nd → 3rd	30
3rd → 4th	40
4th → 5th	50
5th → 6th	60

### NOTE:

When shifting two gears down from 5th to 3rd, bring your motorcycle to a speed of 35 km/h.

## Tips for reducing fuel consumption

Your motorcycle's fuel consumption depends to a large extent on your riding style. The following tips can help reduce fuel consumption:

- Warm up the engine before riding.
- Turn off the starter (choke) as soon as possible.
- Shift up swiftly and avoid high engine speeds during acceleration.
- Do not double-clutch or rev the engine while shifting down and avoid high engine speeds with no load on the engine.
- Turn off the engine instead of letting it idle for an extended length of time, i.e. in traffic jams, at traffic lights or railroad crossings.

## Engine break-in

There is never a more important period in the life of your motorcycle than the period between zero and 1,000 km. For this reason we ask that you carefully read the following material. Because the engine is brand new, you must not put an excessive load on it for the first 1,000 km. The various parts in the engine wear and polish themselves to the correct operating clearances. During this period, prolonged full throttle operation, or any condition which might result in excessive heating of the engine, must be avoided.

# OPERATION AND IMPORTANT RIDING POINTS

## 0 ~ 500 km

EAU00453

Avoid operation above 6,000 r/min. Stop the engine and let it cool for 5 to 10 minutes after every hour of operation. Vary the speed of the motorcycle from time to time. Do not operate it at one set throttle position.

## 500 ~ 1,000 km

Avoid prolonged operation above 7,000 r/min. Rev the motorcycle freely through the gears, but do not use full throttle at any time.

EC000060

### **CAUTION:** \_\_\_\_\_

After 1,000 km of operation, be sure to replace the transmission oil.

---

## 1,000 km and beyond

Full throttle can be used.

EC000053

### **CAUTION:** \_\_\_\_\_

- Never let engine speeds enter the red zone.
  - If any engine trouble should occur during the break-in period, consult a Yamaha dealer immediately.
- 

## Parking

EAU00458

When parking the motorcycle, stop the engine and remove the ignition key. Turn the fuel cock to “OFF” whenever stopping the engine.

EW000058

### **⚠WARNING** \_\_\_\_\_

The exhaust system is hot. Park the motorcycle in a place where pedestrians or children are not likely to touch the motorcycle. Do not park the motorcycle on a slope or soft ground; the motorcycle may overturn.

---

EC000062

### **CAUTION:** \_\_\_\_\_

Never park this motorcycle in an area that would cause a fire hazard such as grass or other materials that may easily burn.

---



# PERIODIC MAINTENANCE AND MINOR REPAIR

Tool kit .....	6-1	Drive chain lubrication.....	6-25
Periodic maintenance and lubrication .....	6-3	Cable inspection and lubrication .....	6-25
Cowling and panel removal and installation.....	6-6	Throttle cable and grip lubrication .....	6-26
Cowling A, B .....	6-7	Autolube pump adjustment .....	6-26
Panel A .....	6-7	Brake and shift pedal lubrication .....	6-26
Spark plug inspection.....	6-8	Brake and clutch lever lubrication .....	6-27
Transmission oil .....	6-9	Sidestand lubrication.....	6-27
Cooling system .....	6-10	Rear suspension lubrication.....	6-27
Changing the coolant.....	6-11	Front fork inspection .....	6-28
Air filter .....	6-13	Steering inspection .....	6-28
Carburetor adjustment .....	6-15	Wheel bearings .....	6-29
Idle speed adjustment.....	6-15	Battery.....	6-29
Throttle cable free play adjustment.....	6-16	Fuse replacement .....	6-30
Tires .....	6-17	Headlight bulb replacement .....	6-31
Wheels.....	6-19	Taillight bulb replacement .....	6-32
Clutch lever free play adjustment.....	6-19	Turn signal light bulb replacement .....	6-32
Front brake lever free play adjustment .....	6-20	Front wheel removal .....	6-33
Rear brake pedal height adjustment .....	6-20	Front wheel installation .....	6-34
Brake light switch adjustment .....	6-21	Rear wheel removal .....	6-34
Checking the front and rear brake pads.....	6-21	Rear wheel installation .....	6-35
Inspecting the brake fluid level.....	6-22	Troubleshooting .....	6-36
Brake fluid replacement .....	6-23	Troubleshooting chart .....	6-37
Drive chain slack check .....	6-23		
Drive chain slack adjustment .....	6-24		

# PERIODIC MAINTENANCE AND MINOR REPAIR

EAU00464

Periodic inspection, adjustment and lubrication will keep your motorcycle in the safest and most efficient condition possible. Safety is an obligation of the motorcycle owner. The maintenance and lubrication schedule chart should be considered strictly as a guide to general maintenance and lubrication intervals.

YOU MUST TAKE INTO CONSIDERATION THAT WEATHER, TERRAIN, GEOGRAPHICAL LOCATIONS, AND A VARIETY OF INDIVIDUAL USES ALL TEND TO DEMAND THAT EACH OWNER ALTER THIS TIME SCHEDULE TO SHORTER INTERVALS TO MATCH THE ENVIRONMENT. The most important points of motorcycle inspection, adjustment, and lubrication are explained in the following pages.

EW000060

## **⚠ WARNING**

**If you are not familiar with motorcycle service, this work should be done by a Yamaha dealer.**

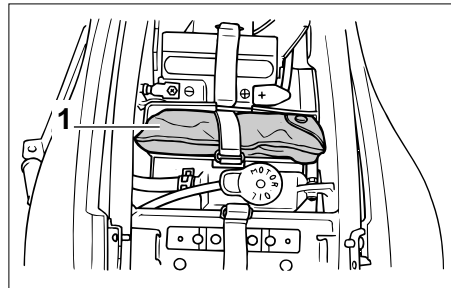

1. Tool kit

EAU00469

## **Tool kit**

The service information included in this manual is intended to provide you, the owner, with the necessary information for completing some of your own preventive maintenance and minor repairs.

The tools provided in the owner's tool kit are to assist you in the performance of periodic maintenance. However, some other tools such as a torque wrench are also necessary to perform the maintenance correctly.

# PERIODIC MAINTENANCE AND MINOR REPAIR

---

**NOTE:** \_\_\_\_\_

If you do not have necessary tools required during a service operation, take your motorcycle to a Yamaha dealer for service.

---

EW000063

**⚠ WARNING** \_\_\_\_\_

**Modifications to this motorcycle not approved by Yamaha may cause loss of performance, and render it unsafe for use. Consult a Yamaha dealer before attempting any changes.**

---

# PERIODIC MAINTENANCE AND MINOR REPAIR

EAU00473

## PERIODIC MAINTENANCE AND LUBRICATION

No.	ITEM	CHECKS AND MAINTENANCE JOBS	Initial (1,000 km)	EVERY	
				6,000 km or 6 months (Whichever comes first)	12,000 km or 12 months (Whichever comes first)
1 *	Fuel line	<ul style="list-style-type: none"> <li>• Check fuel hoses for cracks or damage.</li> <li>• Replace if necessary.</li> </ul>		√	√
2	Spark plug	<ul style="list-style-type: none"> <li>• Check condition.</li> <li>• Clean, regap or replace if necessary.</li> </ul>	√	√	√
3	Air filter	<ul style="list-style-type: none"> <li>• Clean or replace if necessary.</li> </ul>		√	√
4	Clutch	<ul style="list-style-type: none"> <li>• Check operation.</li> <li>• Adjust or replace cable.</li> </ul>	√	√	√
5 *	Front brake	<ul style="list-style-type: none"> <li>• Check operation, fluid level and vehicle for fluid leakage. (See NOTE on page 6-5.)</li> <li>• Correct accordingly.</li> <li>• Replace brake pads if necessary.</li> </ul>	√	√	√
6 *	Rear brake	<ul style="list-style-type: none"> <li>• Check operation, fluid level and vehicle for fluid leakage. (See NOTE on page 6-5.)</li> <li>• Correct accordingly.</li> <li>• Replace brake pads if necessary.</li> </ul>	√	√	√
7 *	Wheels	<ul style="list-style-type: none"> <li>• Check balance, runout and for damage.</li> <li>• Rebalance or replace if necessary.</li> </ul>		√	√
8 *	Tires	<ul style="list-style-type: none"> <li>• Check tread depth and for damage.</li> <li>• Replace if necessary.</li> <li>• Check air pressure.</li> <li>• Correct if necessary.</li> </ul>		√	√
9 *	Wheel bearings	<ul style="list-style-type: none"> <li>• Check bearing for looseness or damage.</li> <li>• Replace if necessary.</li> </ul>		√	√

6



# PERIODIC MAINTENANCE AND MINOR REPAIR

No.	ITEM	CHECKS AND MAINTENANCE JOBS	Initial (1,000 km)	EVERY	
				6,000 km or 6 months (Whichever comes first)	12,000 km or 12 months (Whichever comes first)
10 *	Swingarm	<ul style="list-style-type: none"> <li>• Check swingarm pivoting point for play.</li> <li>• Correct if necessary.</li> <li>• Lubricate with lithium soap base grease every 24,000 km or 24 months (whichever comes first).</li> </ul>		√	√
11	Drive chain	<ul style="list-style-type: none"> <li>• Check chain slack.</li> <li>• Adjust if necessary. Make sure that the rear wheel is properly aligned.</li> <li>• Clean and lubricate.</li> </ul>	Every 1,000 km and after washing the motorcycle or riding in the rain		
12 *	Steering bearings	<ul style="list-style-type: none"> <li>• Check bearing play and steering for roughness.</li> <li>• Correct accordingly.</li> <li>• Lubricate with lithium soap base grease every 24,000 km or 24 months (whichever comes first).</li> </ul>		√	√
13 *	Chassis fasteners	<ul style="list-style-type: none"> <li>• Make sure that all nuts, bolts and screws are properly tightened.</li> <li>• Tighten if necessary.</li> </ul>		√	√
14	Sidestand	<ul style="list-style-type: none"> <li>• Check operation.</li> <li>• Lubricate and repair if necessary.</li> </ul>		√	√
15 *	Sidestand switch	<ul style="list-style-type: none"> <li>• Check operation.</li> <li>• Replace if necessary.</li> </ul>	√	√	√
16 *	Front fork	<ul style="list-style-type: none"> <li>• Check operation and for oil leakage.</li> <li>• Correct accordingly.</li> </ul>		√	√
17 *	Rear shock absorber assembly	<ul style="list-style-type: none"> <li>• Check operation and shock absorber for oil leakage.</li> <li>• Replace shock absorber assembly if necessary.</li> </ul>		√	√
18 *	Rear shock absorber assembly pivoting points	<ul style="list-style-type: none"> <li>• Check operation.</li> <li>• Lubricate with lithium grease every 24,000 km or 24 months (whichever comes first).</li> </ul>		√	√
19 *	Carburetor	<ul style="list-style-type: none"> <li>• Check engine idling speed and starter operation.</li> <li>• Adjust if necessary.</li> </ul>	√	√	√

# PERIODIC MAINTENANCE AND MINOR REPAIR

No.	ITEM	CHECKS AND MAINTENANCE JOBS	Initial (1,000 km)	EVERY	
				6,000 km or 6 months (Whichever comes first)	12,000 km or 12 months (Whichever comes first)
20	* Autolube pump	<ul style="list-style-type: none"> <li>• Check operation.</li> <li>• Correct if necessary.</li> <li>• Bleed if necessary.</li> </ul>	√	√	√
21	Transmission oil	<ul style="list-style-type: none"> <li>• Check oil level and vehicle for oil leakage.</li> <li>• Correct accordingly.</li> <li>• Change oil at initial 1,000 km and thereafter every 24,000 km or 24 months (whichever comes first).</li> </ul>	√	√	√
22	* Cooling system	<ul style="list-style-type: none"> <li>• Check coolant level and vehicle for coolant leakage.</li> <li>• Correct if necessary.</li> <li>• Change coolant every 24,000 km or 24 months (whichever comes first).</li> </ul>		√	√

\* Since these items require special tools, data and technical skills, they should be serviced by a Yamaha dealer.

EAU02970

## NOTE

- The air filter needs more frequent service if you are riding in unusually wet or dusty areas.
- Hydraulic brake system
  - When disassembling the master cylinder or caliper, always replace the brake fluid. Check the brake fluid level regularly and fill as required.
  - Replace the oil seals on the inner parts of the master cylinder and caliper every two years.
  - Replace the brake hoses every four years or if cracked or damaged.

# PERIODIC MAINTENANCE AND MINOR REPAIR

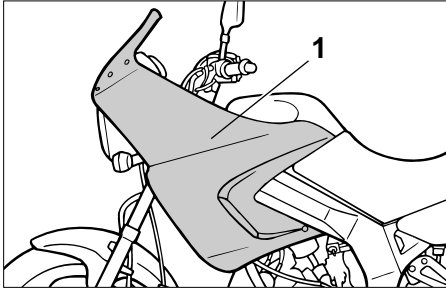

1. Cowling A

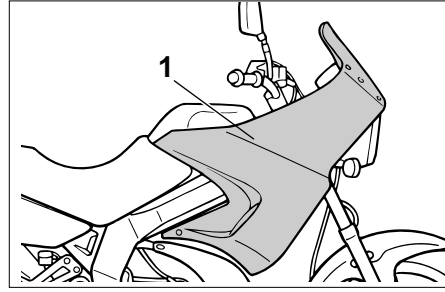

1. Cowling B

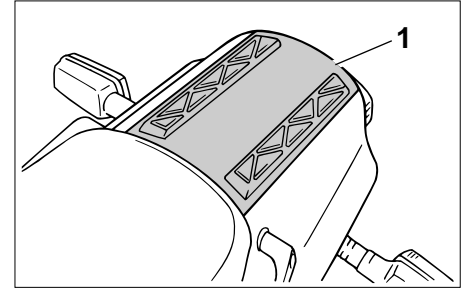

1. Panel A

EAU01139

## Cowling and panel removal and installation

The cowlings and panels illustrated need to be removed to perform some of the maintenance described in this chapter.

Refer to this section each time a cowling or panel has to be removed or reinstalled.

# PERIODIC MAINTENANCE AND MINOR REPAIR

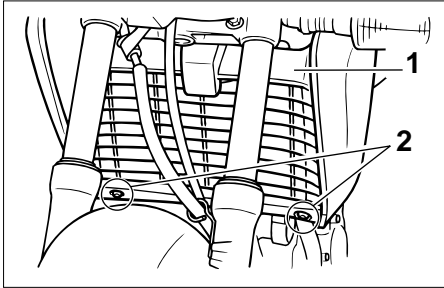

1. Radiator cover
2. Screw (×2)

EAU01088

## Cowling A, B

### To remove

1. Remove the seat.
2. Remove the radiator cover screws and the radiator cover.

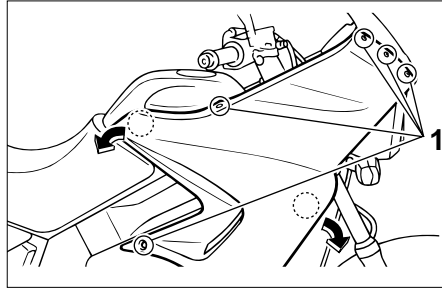

1. Screw (×10)
3. Remove the screws and pull outward on the areas shown.

### To install

1. Place the cowling in the original position and install the screws.
2. Place the radiator cover in the original position and install the screws.
3. Install the seat.

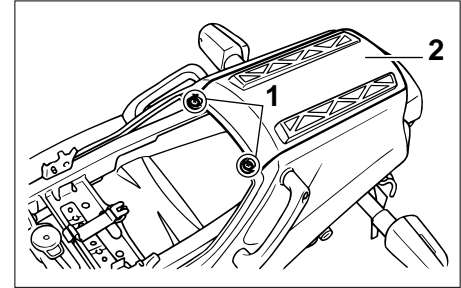

1. Screw (×2)
2. Panel A

EAU01691

## Panel A

### To remove

1. Remove the seat. (See page 3-13 for removal and installation procedures.)
2. Remove the screw.

### To install

1. Place the panel in the original position and install the screw.
2. Install the seat.

# PERIODIC MAINTENANCE AND MINOR REPAIR

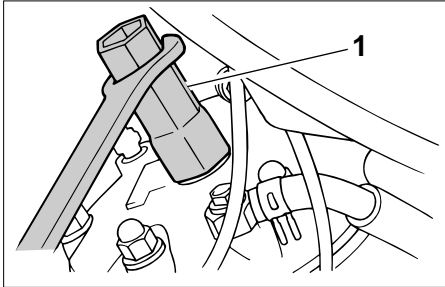

1. Spark plug wrench

EAU01651

## Spark plug inspection

The spark plug is an important engine component and should be inspected periodically, preferably by a Yamaha dealer. The condition of the spark plug can indicate the condition of the engine. The ideal color on the white insulator around the center electrode is a medium-to-light tan color for a motorcycle that is being ridden normally. Do not attempt to diagnose any problems yourself. Instead, take the motorcycle to a Yamaha dealer. The spark plug should be periodically removed and inspected because heat and deposits

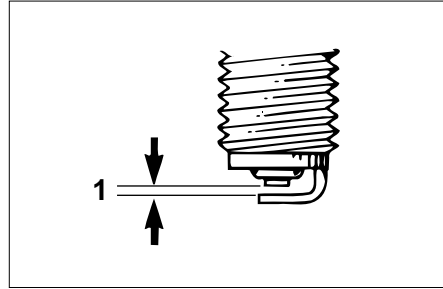

1. Spark plug gap

will cause the spark plug to slowly break down and erode. If electrode erosion becomes excessive, or if carbon and other deposits are excessive, the spark plug should be replaced with the specified plug.

Specified spark plug:  
BR9ES (NGK)

Before installing the spark plug, measure the electrode gap with a wire thickness gauge and adjust it to specification.

Spark plug gap:  
0.7 ~ 0.8 mm

When installing the plug, the gasket surface should always be cleaned and a new gasket used. Any grime should be wiped off from the threads and the spark plug tightened to the specified torque.

Tightening torque:  
Spark plug:  
20 Nm (2.0 m·kg)

**NOTE:** \_\_\_\_\_  
If a torque wrench is not available when installing a spark plug, a good estimate of the correct torque is 1/4 to 1/2 turn past finger tight. The spark plug should be tightened to the specified torque as soon as possible.

# PERIODIC MAINTENANCE AND MINOR REPAIR

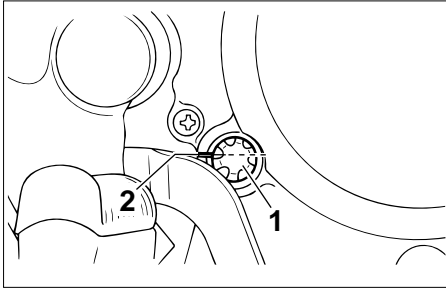

1. Level window
2. Minimum level

EAU01080

## Transmission oil Oil level measurement

1. Place the motorcycle on a level place and hold it an upright position. Warm up the engine for several minutes.

**NOTE:** \_\_\_\_\_

Be sure the motorcycle is positioned straight up when checking the oil level. A slight tilt toward the side can result in false readings.

2. With the engine stopped, check the oil level through the level window located at the right side crankcase cover.

**NOTE:** \_\_\_\_\_

Wait a few minutes until the oil level settles before checking.

3. The oil level should be above the minimum level mark on the level window. If the level is low, add sufficient oil to raise it to the proper level.

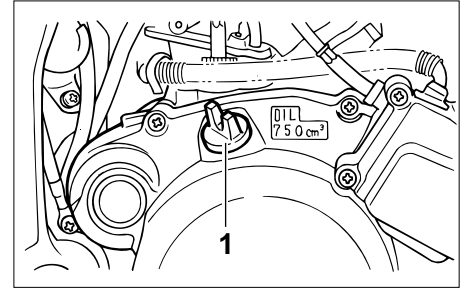

1. Transmission oil filler cap

## Transmission oil replacement

1. Warm up the engine for several minutes.
2. Stop the engine. Place an oil pan under the engine and remove the oil filler cap.

# PERIODIC MAINTENANCE AND MINOR REPAIR

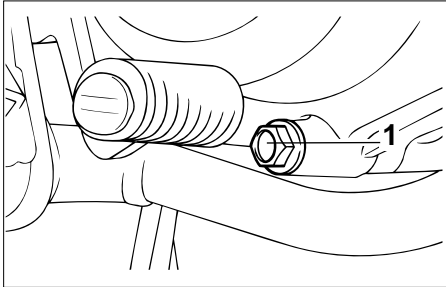

1. Drain bolt

3. Remove the drain bolt and drain the oil.
4. Reinstall the drain bolt and tighten it to the specified torque.

Tightening torque:  
Drain bolt:  
15 Nm (1.5 m·kg)

5. Fill the engine with oil. Install the oil filler cap and tighten it.

Recommended oil:  
See page 8-1  
Oil quantity:  
Total amount: 0.8 L  
Periodic oil change: 0.75 L

EC000078

## CAUTION:

- **Do not put in any chemical additives. Transmission oil also lubricates the clutch and additives could cause clutch slippage.**
- **Be sure no foreign material enters the crankcase.**

6. Start the engine and warm up for a few minutes. While warming up, check for oil leakage. If oil leakage is found, stop the engine immediately and check for cause.

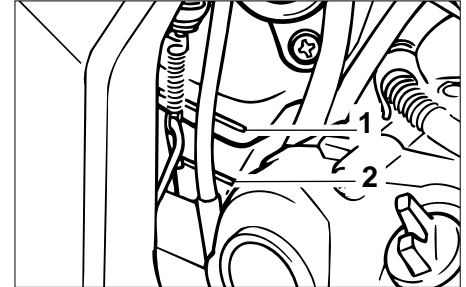

1. Maximum level mark
2. Minimum level mark

EAU01621\*

## Cooling system

1. Check the coolant level in the reservoir tank when the engine is cold as the coolant level will vary with engine temperature. The coolant level should be between the minimum and maximum marks on the tank.
2. If the coolant level is at or below the minimum mark, fill with tap water (soft water) to bring the level up to the specified level. Change the coolant every two years.
3. If your motorcycle overheats, see page 6-38 for details.

# PERIODIC MAINTENANCE AND MINOR REPAIR

## **⚠ WARNING**

EW000067

Do not remove the radiator cap when the engine is hot.

## **CAUTION:**

EC000080

Hard water or salt water is harmful to the engine. You may use distilled water if you can't get soft water.

## Changing the coolant

EAU01622\*

1. Put the motorcycle on a level place.
2. Remove the seat (See page 3-13 for seat removal procedures.)
3. Remove cowling B and radiator cover. (See page 6-7 for removal and installation procedures.)

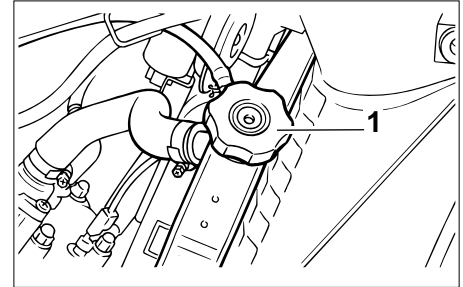

1. Radiator cap

4. Remove the radiator cap.



# PERIODIC MAINTENANCE AND MINOR REPAIR

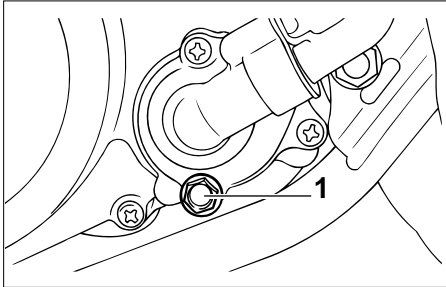

1. Drain bolt

5. Place a container under the engine and remove the coolant drain bolt.

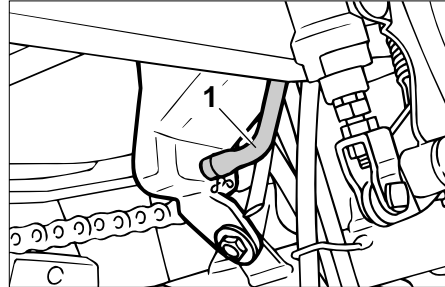

1. Reservoir tank hose

6. Disconnect the reservoir tank hose on the reservoir tank side and drain the coolant from the reservoir tank.
7. After draining the coolant, thoroughly flush the cooling system with clean tap water.
8. Replace the coolant drain bolt washer if it is damaged and tighten the coolant drain bolt to the specified torque.

Tightening torque:

Coolant drain bolt:

8 Nm (0.8 m·kg)

9. Install the reservoir tank hose.
10. Pour the recommended coolant into the radiator until it is full.

Recommended antifreeze:

High quality ethylene glycol antifreeze containing corrosion inhibitors for aluminum engines

Antifreeze and water mixing ratio:

1:1

Total amount:

1.05 L

Reservoir tank capacity:

0.35 L

EC000080

**CAUTION:** \_\_\_\_\_

**Hard water or salt water is harmful to the engine. You may use distilled water if you can't get soft water.**

# PERIODIC MAINTENANCE AND MINOR REPAIR

11. Install the radiator cap.
12. Run the engine several minutes. Stop the engine and recheck the coolant level in the radiator. If it is low, add more coolant until it reaches the top of the radiator.

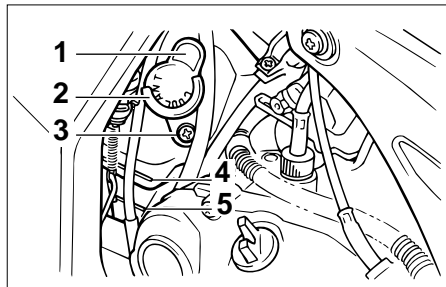

1. Reservoir tank cap
2. Stopper
3. Stopper bolt
4. Maximum level mark
5. Minimum level mark

13. Fill the reservoir tank with coolant up to specified level.
14. Install the reservoir tank cap and check for coolant leakage.

**NOTE:** \_\_\_\_\_

If any leakage is found, ask a Yamaha dealer to inspect the cooling system.

\_\_\_\_\_

15. Install the cowling, radiator cover and the seat.

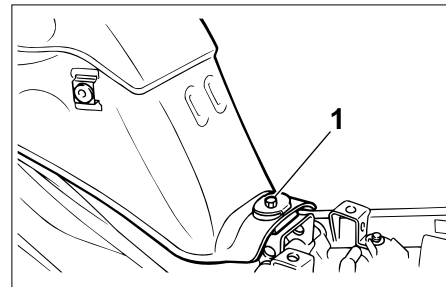

1. Bolt

EAU01476\*

## Air filter

The air filter should be cleaned at the specified intervals. It should be cleaned more frequently if you are riding in unusually wet or dusty areas.

1. Remove the seat.
2. Remove cowling A and B. (See page 6-7 for cowling removal and installation steps.)
3. Remove the fuel tank bolt.
4. Lift the front of the fuel tank upward and position it away from the air filter case. (Do not remove the fuel hoses.)

# PERIODIC MAINTENANCE AND MINOR REPAIR

## ⚠ WARNING

EW000071

- Support the fuel tank carefully during this procedure.
- Do not tilt the fuel tank too much or pull it too hard because the fuel hose connections may become loose causing fuel leakage.

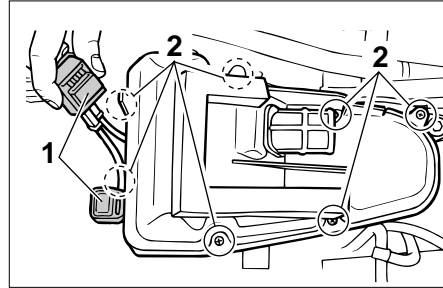

1. Relay (×2)
2. Screw (×7)

5. Remove the relays and the screws holding the air filter case cover.

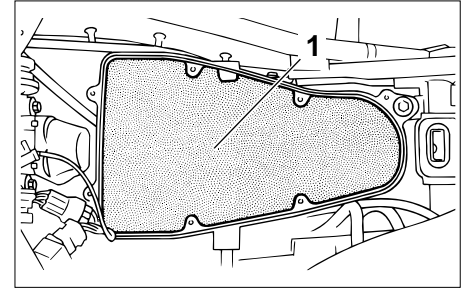

1. Air filter

6. Remove the air filter element from its case and clean it with solvent. After cleaning, remove the remaining solvent by squeezing the air filter.
7. Apply recommended oil to the entire surface of the air filter and squeeze out the excess oil. The air filter should be wet but not dripping.

Recommended oil:  
2-stroke engine oil

8. Install the air filter element in its case.
9. Reinstall the parts removed for access.

# PERIODIC MAINTENANCE AND MINOR REPAIR

## CAUTION:

EC000082

- Make sure the air filter is properly seated in the air filter case.
- The engine should never be run without the air filter installed. Excessive piston and/or cylinder wear may result.

## WARNING

EW000131

Make sure that the fuel hoses and vacuum hose are properly connected, in place and not pinched. If a hose is damaged, be sure to replace it.

## Carburetor adjustment

EAU00629

The carburetor is a vital part of the engine and requires very sophisticated adjustment. Most adjustments should be left to a Yamaha dealer who has the professional knowledge and experience to do so. However, the following may be serviced by the owner as part of routine maintenance.

## CAUTION:

EC000094

The carburetor was set at the Yamaha factory after many tests. If the settings are changed, poor engine performance and damage may result.

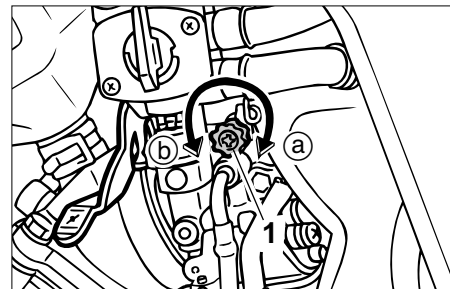

1. Throttle stop screw

EAU00632

## Idle speed adjustment

1. Start the engine and warm it up for a few minutes at approximately 1,000 to 2,000 r/min. Occasionally rev the engine to 4,000 to 5,000 r/min. The engine is warm when it quickly responds to the throttle.
2. Set the idle to the specified engine speed by adjusting the throttle stop screw. Turn the screw in direction (a) to increase engine speed and in direction (b) to decrease engine speed.

# PERIODIC MAINTENANCE AND MINOR REPAIR

Standard idle speed:  
1,300 ~ 1,500 r/min  
1,400 ~ 1,500 r/min  
(A, CH only)

## NOTE:

If the specified idle speed cannot be obtained by performing the above adjustment, consult a Yamaha dealer.

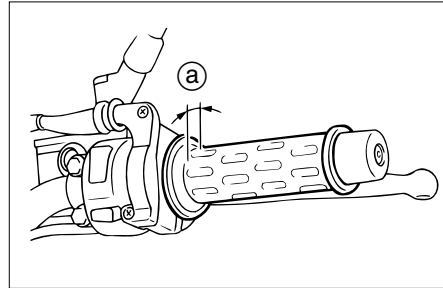

a. Free play

EAU00634

## Throttle cable free play adjustment

### NOTE:

Before checking the throttle cable free play, the engine idling speed should be adjusted.

Adjust the throttle cable by turning the adjusting nut so that specified free play at the throttle grip is obtained.

Free play:  
3 ~ 5 mm

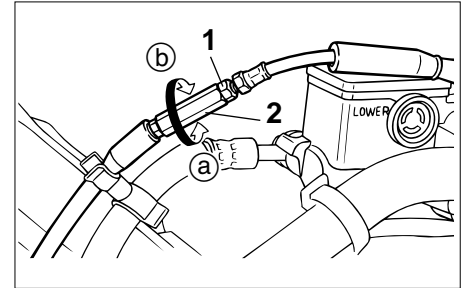

1. Locknut
2. Adjusting nut

1. Loosen the locknut.
2. Turn the adjusting nut in direction (a) to increase free play and in direction (b) to decrease free play.
3. Tighten the locknut.

# PERIODIC MAINTENANCE AND MINOR REPAIR

## Tires

EAU00647

To ensure maximum performance, long service, and safe operation, note the following:

### Tire air pressure

Always check and adjust the tire pressure before operating the motorcycle.

EW000082

#### **⚠WARNING**

Tire inflation pressure should be checked and adjusted when the temperature of the tire equals the ambient air temperature. Tire inflation pressure must be adjusted according to total weight of cargo, rider, passenger, and accessories (fairing, saddlebags, etc. if approved for this model), and vehicle speed.

Maximum load*	180 kg 179 kg (CH, A)	
Cold tire pressure	Front	Rear
Up to 90 kg load*	175 kPa (1.75 kg/cm <sup>2</sup> , 1.75 bar)	200 kPa (2.00 kg/cm <sup>2</sup> , 2.00 bar)
90 kg load ~ Maximum load*	175 kPa (1.75 kg/cm <sup>2</sup> , 1.75 bar)	225 kPa (2.25 kg/cm <sup>2</sup> , 2.25 bar)

\* Load is the total weight of cargo, rider, passenger and accessories.

EW000083

#### **⚠WARNING**

Proper loading of your motorcycle is important for several characteristics of your motorcycle, such as handling, braking, performance and safety. Do not carry loosely packed items that can shift. Securely pack your heaviest items close to the center of the motorcycle, and distribute the weight evenly from side to side. Properly adjust the suspension for your load, and check the condition and pressure of your tires. NEVER OVERLOAD YOUR MOTORCYCLE. Make sure the total weight of the cargo, rider, passenger, and accessories (fairing, saddlebags, etc. if approved for this model) does not exceed the maximum load of the motorcycle. Operation of an overloaded motorcycle could cause tire damage, an accident, or even injury.

# PERIODIC MAINTENANCE AND MINOR REPAIR

EAU00683

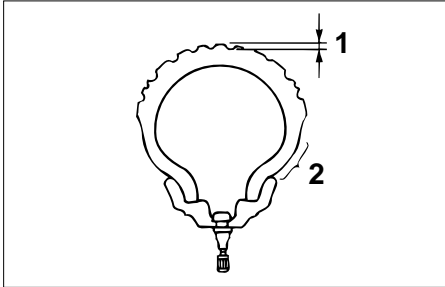

1. Tread depth
2. Side wall

## Tire inspection

Always check the tires before operating the motorcycle. If center tread depth reaches the limit as shown, if the tire has a nail or glass fragments in it, or if the side wall is cracked, contact a Yamaha dealer immediately and have the tire replaced.

## FRONT

Manufacturer	Size	Type
BRIDGESTONE	100/90-18 56P	TW53
DUNLOP	100/90-18 56P	D602F

## REAR

Manufacturer	Size	Type
BRIDGESTONE	130/80-17 65P	TW54
DUNLOP	130/80-17 65P	D602

Minimum tire tread depth (front and rear)	0.8 mm
----------------------------------------------	--------

## NOTE:

These limits may be different by regulation from country to country. If so, conform to the limits specified by the regulations of your own country.

## **WARNING**

Operating the motorcycle with excessively worn tires decrease riding stability and can lead to loss of control. Have excessively worn tires replaced by a Yamaha dealer immediately. Brakes, tires, and related wheel parts replacement should be left to a Yamaha Service Technician.

# PERIODIC MAINTENANCE AND MINOR REPAIR

## Wheels

EAU00687

To ensure maximum performance, long service, and safe operation, note the following:

- Always inspect the wheels before a ride. Check for cracks, bends, or warpage of the wheels. If any abnormal condition exists in a wheel, consult a Yamaha dealer. Do not attempt even small repairs to the wheel. If a wheel is deformed or cracked, it must be replaced.
- Tires and wheels should be balanced whenever either one is changed or replaced. Failure to have a wheel balanced can result in poor performance, adverse handling characteristics, and shortened tire life.
- Ride at moderate speeds after changing a tire since the tire surface must first be broken in for it to develop its optimal characteristics.

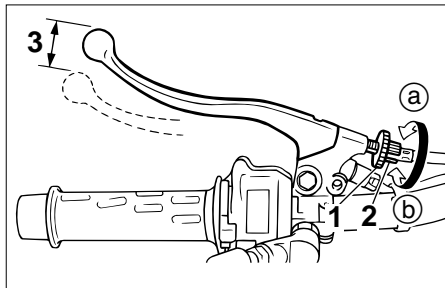

1. Locknut
2. Adjusting bolt
3. Free play

EAU00694

## Clutch lever free play adjustment

The clutch lever free play should be adjusted to 10 ~ 15 mm.

1. Loosen the locknut at the clutch lever.
2. Turn the adjusting bolt at the clutch lever in direction (a) to increase free play or in direction (b) to decrease free play.
3. Tighten the locknut at the clutch lever.

If the specified free play cannot be obtained, proceed with the following steps.

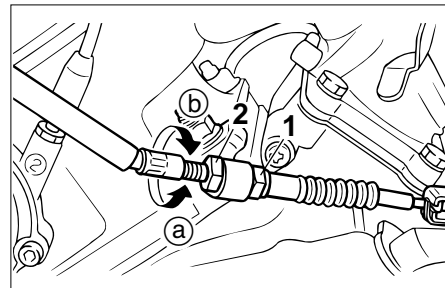

1. Locknut
2. Adjusting nut

4. Loosen the locknut at the clutch lever.
5. Turn the adjusting bolt at the clutch lever in direction (a) to loosen the cable.
6. Loosen the locknut at the crankcase side.
7. Turn the adjusting nut at the crankcase in direction (a) to increase free play or in direction (b) to decrease free play.
8. Tighten the locknut at the crankcase and the clutch lever.



# PERIODIC MAINTENANCE AND MINOR REPAIR

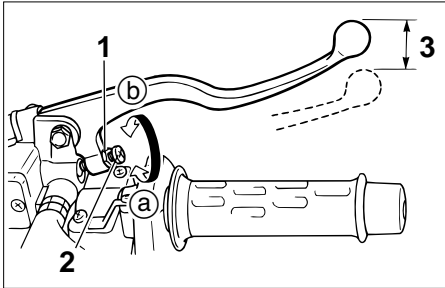

1. Locknut
2. Adjusting bolt
3. Free play

EAU00696

## Front brake lever free play adjustment

The free play at the front brake lever should be 2 ~ 5 mm.

1. Loosen the locknut.
2. Turn the adjusting bolt in direction (a) to increase free play or in direction (b) to decrease free play.
3. After adjusting, tighten the locknut.

EW000099

## ⚠ WARNING

- Check the brake lever free play. Be sure the brake is working properly.
- A soft or spongy feeling in the brake lever can indicate the presence of air in the brake system. This air must be removed by bleeding the brake system before the motorcycle is operated. Air in the system will cause greatly diminished braking capability and can result in loss of control and an accident. Have a Yamaha dealer inspect and bleed the system if necessary.

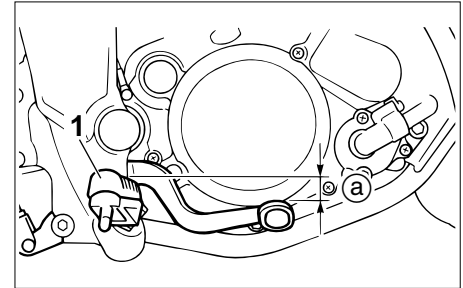

1. Footrest
- a. Pedal height

EAU00712

## Rear brake pedal height adjustment

The top of the brake pedal should be positioned 23 mm below the top of the footrest. If not, ask a Yamaha dealer to adjust it.

# PERIODIC MAINTENANCE AND MINOR REPAIR

## **⚠ WARNING**

EW000109

A soft or spongy feeling in the brake pedal can indicate the presence of air in the brake system. This air must be removed by bleeding the brake system before the motorcycle is operated. Air in the system will cause greatly diminished braking capability and can result in loss of control and an accident. Have a Yamaha dealer inspect and bleed the system if necessary.

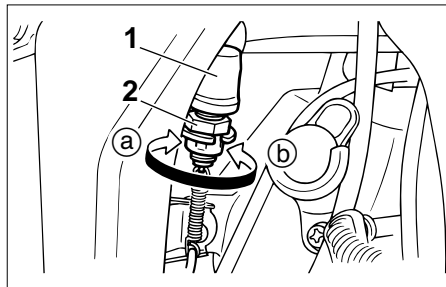

1. Brake light switch
2. Adjusting nut

EAU00713

## **Brake light switch adjustment**

The rear brake light switch is activated by the brake pedal and is properly adjusted when the brake light comes on just before braking takes effect. To adjust the rear brake light switch, hold the switch body so it does not rotate while turning the adjusting nut. Turn the adjusting nut in direction Ⓐ to make the brake light come on earlier.

Turn the adjusting nut in direction Ⓑ to make the brake light come on later.

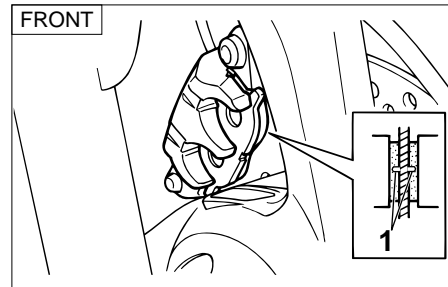

1. Wear indicator groove

EAU00721

## **Checking the front and rear brake pads**

EAU00725

### **Front brake**

A wear indicator groove is provided on each brake pad. This indicator allows checking of brake pad wear without disassembling the brake. Inspect the groove. If the groove has almost disappeared, ask a Yamaha dealer to replace the pads.

# PERIODIC MAINTENANCE AND MINOR REPAIR

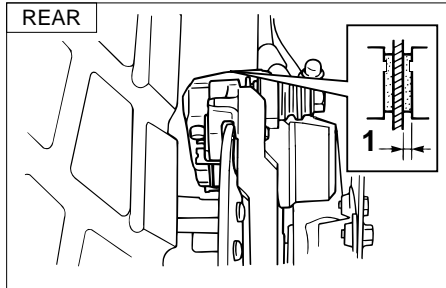

1. Wear limit: 0.8 mm

EAU00730

## Rear brake

Inspect the pads through the window as shown.

If the thickness is less than the specified value, have a Yamaha dealer replace the pads.

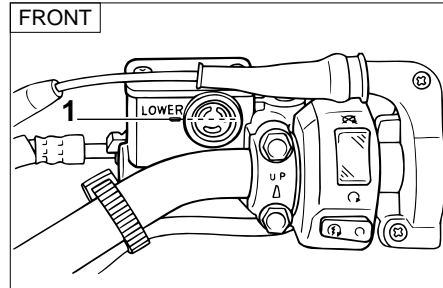

1. Minimum level mark

EAU00733

## Inspecting the brake fluid level

Insufficient brake fluid may let air enter the brake system, possibly causing the brakes to become ineffective.

Before riding, check that the brake fluid is above the minimum level and replenish when necessary.

Observe these precautions:

- When checking the fluid level, make sure the top of the master cylinder is level by turning the handlebars.

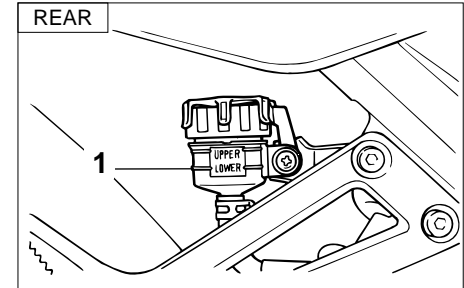

1. Minimum level mark

- Use only the designated quality brake fluid. Otherwise, the rubber seals may deteriorate, causing leakage and poor brake performance.

Recommended fluid:  
DOT 4

## NOTE:

If DOT 4 is not available, DOT 3 can be used for the front brake only.

# PERIODIC MAINTENANCE AND MINOR REPAIR

- Refill with the same type of brake fluid. Mixing fluids may result in a harmful chemical reaction and lead to poor brake performance.
- Be careful that water does not enter the master cylinder when refilling. Water will significantly lower the boiling point of the fluid and may result in vapor lock.
- Brake fluid may deteriorate painted surfaces or plastic parts. Always clean up spilled fluid immediately.
- Have a Yamaha dealer check the cause if the brake fluid level goes down.

## Brake fluid replacement

EAU00742

The brake fluid should be replaced only by trained Yamaha service personnel. Have the Yamaha dealer replace the following components during periodic maintenance or when they are damaged or leaking:

- oil seals (every two years)
- brake hoses (every four years)

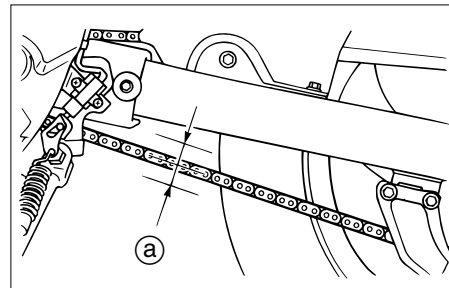

a. Chain slack

## Drive chain slack check

EAU00744

### NOTE:

Spin the wheel several times and find the tightest position of the chain. Check and/or adjust the chain slack while it's in this tightest position.

# PERIODIC MAINTENANCE AND MINOR REPAIR

To check the chain slack the motorcycle must be held straight up with both wheels on the ground and without rider. Check the slack at the position shown in the illustration. Normal slack is approximately 25 ~ 40 mm. If the slack exceeds 40 mm, adjust.

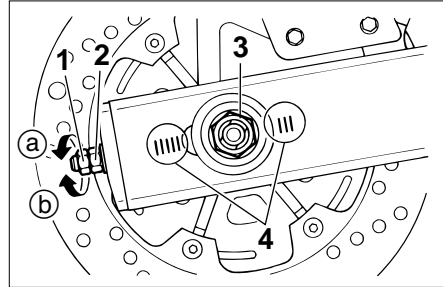

1. Locknut
2. Adjusting nut
3. Axle nut
4. Alignment marks

EAU00762

## Drive chain slack adjustment

1. Loosen the axle nut.
2. Loosen the locknuts on each side. To tighten the chain, turn the chain adjusting nuts in direction (a). To loosen the chain, turn the adjusting nuts in direction (b) and push the wheel forward.

Turn each adjusting nut exactly the same amount to maintain correct axle alignment. There are marks on each side of the swingarm. Use these marks to align the rear wheel.

EC000096

### CAUTION:

**Too little chain slack will overload the engine and other vital parts. Keep the slack within the specified limits.**

3. After adjusting, tighten the locknuts. Then tighten the axle nut to the specified torque.

Tightening torque:

Axle nut:

104 Nm (10.4 m·kg)

# PERIODIC MAINTENANCE AND MINOR REPAIR

---

EAU03006

## Drive chain lubrication

The chain consists of many parts which work with each other. If the chain is not maintained properly, it will wear out quickly. Therefore, the chain must be serviced regularly. This service is especially necessary when riding in dusty areas. This motorcycle is equipped with a sealed type chain. Steam cleaning, high-pressure washers, and solvents can damage the drive chain, so do not use these for cleaning it. Use only kerosene to clean the drive chain. Wipe it dry, and thoroughly lubricate it with SAE 30 ~ 50W motor oil. Do not use any other lubricants on the drive chain. They may contain solvents that could damage the sealed chain.

EC000097

### **CAUTION:**

**Be sure to oil the chain after washing the motorcycle or riding in the rain.**

---

EAU02962

## Cable inspection and lubrication

EW000112

### **⚠ WARNING**

**Damage to the outer housing of cables may lead to internal rusting and interfere with the cable movement. Replace damaged cables as soon as possible to prevent unsafe conditions.**

---

Lubricate the cables and cable ends. If a cable does not operate smoothly, ask a Yamaha dealer to replace it.

Recommended lubricant:  
Engine oil

EAU00773

## Throttle cable and grip lubrication

The throttle twist grip assembly should be greased at the time that the cable is lubricated, since the grip must be removed to get at the end of the throttle cable. After removing the screws, hold the end of the cable up in the air and put in several drops of lubricant. With the throttle grip disassembled, coat the metal surface of the grip assembly with a suitable all-purpose grease.

# PERIODIC MAINTENANCE AND MINOR REPAIR

---

EAU00774

## **Autolube pump adjustment**

The autolube pump is a vital part of the engine and requires very sophisticated adjustment.

Adjusting should be left to a Yamaha dealer who has the professional knowledge and experience to do so.

EAU02984

## **Brake and shift pedal lubrication**

Lubricate the pivoting parts.

Recommended lubricant:  
Engine oil

EAU02985

## **Brake and clutch lever lubrication**

Lubricate the pivoting parts.

Recommended lubricant:  
Engine oil

# PERIODIC MAINTENANCE AND MINOR REPAIR

## Sidestand lubrication

EAU02986

Lubricate the sidestand pivoting point and metal-to-metal contact surfaces. Check that the sidestand moves up and down smoothly.

Recommended lubricant:  
Engine oil

EW000113

### **⚠WARNING**

If the sidestand does not move smoothly, consult a Yamaha dealer.

## Rear suspension lubrication

EAU00791

Lubricate the pivoting parts.

Recommended lubricant:  
Lithium soap base grease

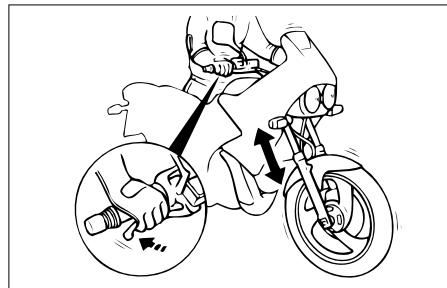

## Front fork inspection

EAU02939

### Visual check

EW000115

### **⚠WARNING**

Securely support the motorcycle so there is no danger of it falling over.

Check for scratches or damage on the inner tube and excessive oil leakage from the front fork.



# PERIODIC MAINTENANCE AND MINOR REPAIR

## Operation check

1. Place the motorcycle on a level place.
2. Hold the motorcycle in an upright position and apply the front brake.
3. Push down hard on the handlebars several times and check if the fork rebounds smoothly.

EC000098

## CAUTION:

**If any damage or unsmooth movement is found with the front fork, consult a Yamaha dealer.**

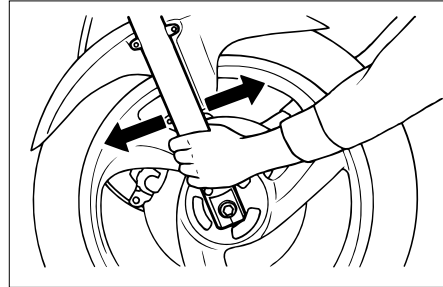

EAU00794

## Steering inspection

Periodically inspect the condition of the steering. Worn out or loose steering bearings may be dangerous. Place a stand under the engine to raise the front wheel off the ground. Hold the lower end of the front forks and try to move them forward and backward. If any free play can be felt, ask a Yamaha dealer to inspect and adjust the steering. Inspection is easier if the front wheel is removed.

EW000115

## WARNING

**Securely support the motorcycle so there is no danger of it falling over.**

# PERIODIC MAINTENANCE AND MINOR REPAIR

---

## Wheel bearings

EAU001144

If there is play in the front or rear wheel hub or if the wheel does not turn smoothly, have a Yamaha dealer inspect the wheel bearings.

## Battery

EAU00800

This motorcycle is equipped with a sealed-type battery. Therefore it is not necessary to check the electrolyte or fill the battery with distilled water.

- If the battery seems to have discharged, consult a Yamaha dealer.
- If the motorcycle is equipped with optional electrical accessories, the battery tends to discharge more quickly, so be sure to recharge it periodically.

EC000101

### **CAUTION:**

**Never try to remove the sealing caps of the battery cells. The battery will be damaged.**

---

EW000116

### **⚠ WARNING**

**Battery electrolyte is poisonous and dangerous, causing severe burns, etc. It contains sulfuric acid. Avoid contact with skin, eyes or clothing.**

#### **ANTIDOTE:**

- **EXTERNAL:** Flush with water.
- **INTERNAL:** Drink large quantities of water or milk. Follow with milk of magnesia, beaten egg, or vegetable oil. Call a physician immediately.
- **EYES:** Flush with water for 15 minutes and get prompt medical attention.

**Batteries produce explosive gases. Keep sparks, flame, cigarettes etc., away. Ventilate when charging or using in an enclosed space. Always shield your eyes when working near batteries.**

**KEEP OUT OF REACH OF CHILDREN.**

---

# PERIODIC MAINTENANCE AND MINOR REPAIR

## Battery storage

When the motorcycle is not used for a month or longer, remove the battery, fully charge it and store it in a cool, dry place.

EC000102

### CAUTION:

- Completely recharge the battery before storing. Storing a discharged battery can cause permanent battery damage.
- Use a battery charger designed for a sealed-type (MF) battery. Using a conventional battery charger will cause battery damage. If you do not have a sealed-type battery charger, contact your Yamaha dealer.
- Always make sure the connections are correct when reinstalling the battery.

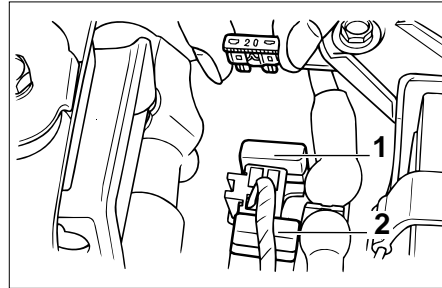

1. Main fuse
2. Spare fuse

EAU00806

## Fuse replacement

The fuse box is located under the seat.

If the fuse is blown, turn off the main switch and the switch of the circuit in question. Install a new fuse of specified amperage. Turn on the switches and see if the electrical device operates. If the fuse immediately blows again, consult a Yamaha dealer.

EC000103

### CAUTION:

Do not use fuses of higher amperage rating than those recommended. Substitution of a fuse of improper rating can cause extensive electrical system damage and possibly a fire.

Specified fuse:  
20A

# PERIODIC MAINTENANCE AND MINOR REPAIR

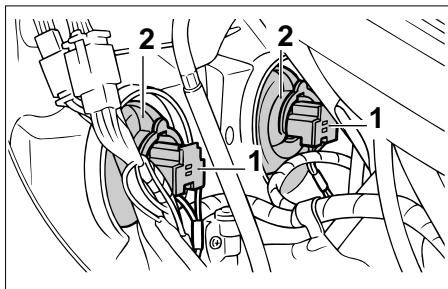

1. Headlight connector
2. Bulb holder cover

EAU01079\*

## Headlight bulb replacement

If the headlight bulb burns out, replace the bulb as follows:

1. Remove cowling A and B. (See page 6-7 for removal and installation procedures.)
2. Disconnect the headlight connector and remove the bulb holder cover.
3. Remove the bulb holder.

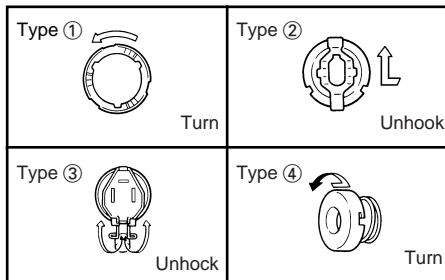

### NOTE:

Removal procedure is different depending on the bulb holder type. Remove your bulb holder by referring to the above illustration.

4. Remove the defective bulb.

EW000119

### **WARNING**

**Keep flammable products and your hands away from a bulb while it is on, as it is hot. Do not touch a bulb until it cools down.**

5. Put a new bulb into position and secure it in place with the bulb holder.

EC000105

### **CAUTION:**

**Avoid touching the glass part of a bulb. Keep it free from oil; otherwise, the transparency of the glass, life of the bulb, and luminous flux will be adversely affected. If oil gets on a bulb, thoroughly clean it with a cloth moistened with alcohol or lacquer thinner.**

6. Install the bulb holder cover.
7. Install the headlight connector and the cowling.

If the headlight beam adjustment is necessary, ask a Yamaha dealer to make adjustment.

# PERIODIC MAINTENANCE AND MINOR REPAIR

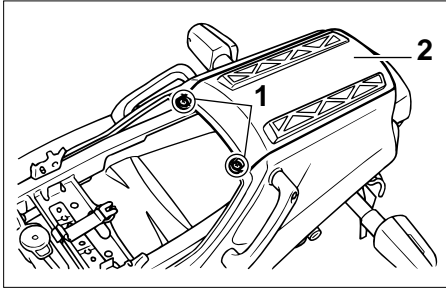

1. Screw (x2)
2. Panel A

EAU01078

## Taillight bulb replacement

1. Remove the seat.
2. Remove panel A. (See page 6-7 for panel removal and installation procedures.)
3. To remove the socket, turn it counterclockwise.

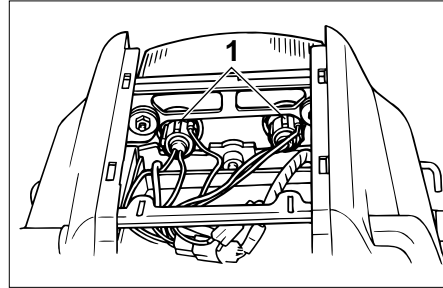

1. Socket

4. To remove the defective bulb, turn it counterclockwise.
5. Push a new bulb into the socket and turn it clockwise.
6. Install the socket and turn it clockwise.
7. Install the panel and the seat.

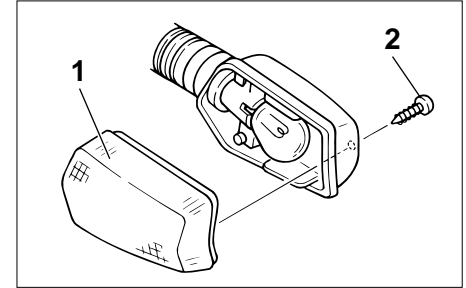

1. Lens
2. Screw

EAU01095

## Turn signal light bulb replacement

1. Remove the screw and the lens.
2. Remove the defective bulb by pushing it inward and turning it counterclockwise.

# PERIODIC MAINTENANCE AND MINOR REPAIR

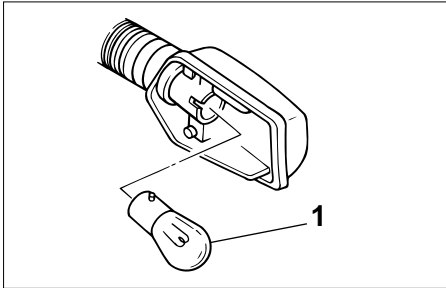

1. Bulb

3. Install a new bulb by pushing it inward and turning it clockwise.
4. Install the lens and tighten the screw.

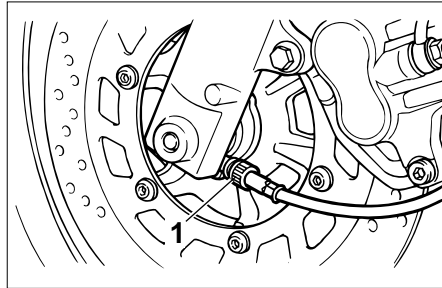

1. Speedometer cable

EAU00894

EW000122

## Front wheel removal

### **WARNING**

- It is advisable to have a Yamaha dealer service the wheel.
- Securely support the motorcycle so there is no danger of it falling over.

1. Remove the speedometer cable from the front wheel side.

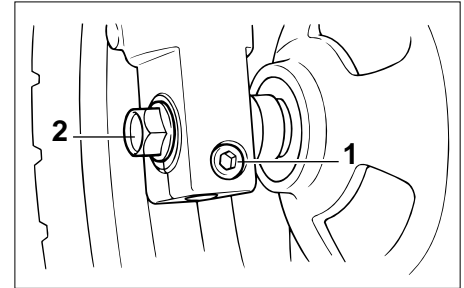

1. Pinch bolt  
2. Wheel axle

2. Loosen the pinch bolt and wheel axle.
3. Elevate the front wheel by placing a suitable stand under the engine.
4. Remove the wheel axle and the front wheel.

### **NOTE:**

Do not depress the brake lever when the disc and caliper are separated.

# PERIODIC MAINTENANCE AND MINOR REPAIR

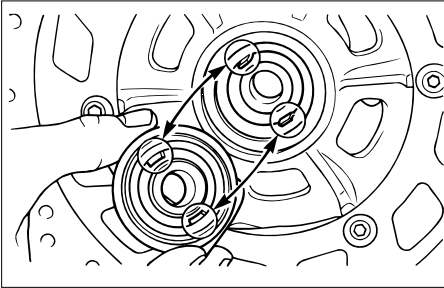

EAU01394

## Front wheel installation

1. Install the speedometer gear unit into the wheel hub. Make sure the wheel hub and the speedometer gear unit are installed with the projections meshed into the slots.
2. Lift up the wheel between the front fork legs and guide the brake disc between the brake pads. Make sure the slot in the speedometer gear unit fits over the stopper on the front fork outer tube.

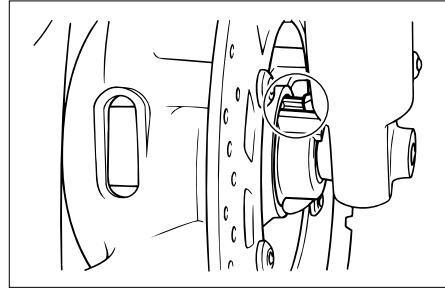

3. Install the wheel axle and let the motorcycle down.
4. Push down hard on the handlebars several times to check for proper fork operation.
5. Tighten the wheel axle to the specified torque.
6. Install the pinch bolt and tighten it to the specified torque.

Tightening torque:

Wheel axle:

59 Nm (5.9 m·kg)

Pinch bolt:

20 Nm (2.0 m·kg)

7. Install the speedometer cable.

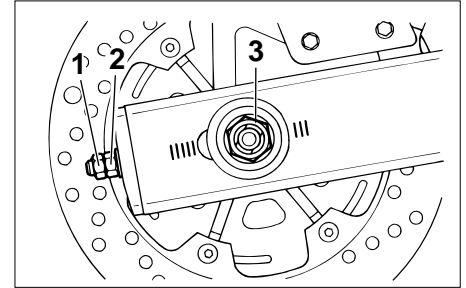

1. Locknut
2. Adjusting nut
3. Axle nut

EAU01618

## Rear wheel removal

EW000122

### **⚠ WARNING**

- It is advisable to have a Yamaha dealer service the wheel.
- Securely support the motorcycle so there is no danger of it falling over.

1. Loosen the axle nut.

# PERIODIC MAINTENANCE AND MINOR REPAIR

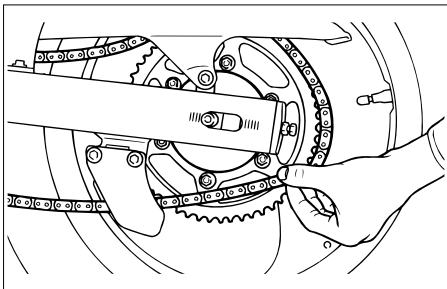

## NOTE:

- Do not depress the brake pedal when the disc and caliper are separated.
- You do not have to disassemble the chain in order to remove or install the rear wheel.

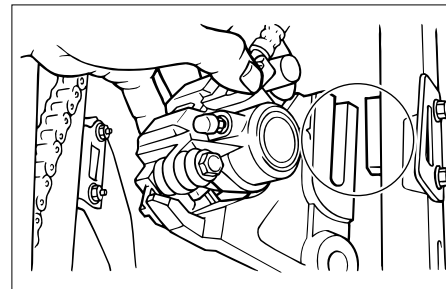

EAU01620

2. Elevate the rear wheel by placing a suitable stand under the engine.
3. Remove the axle nut.
4. Loosen the locknuts and chain adjusting nuts on each side.
5. Push the wheel forward and remove the drive chain.
6. While supporting the brake caliper, pull out the wheel axle.
7. Remove the wheel assembly.

## Rear wheel installation

1. Install the rear brake caliper. Make sure the slot in the caliper bracket is fit over the stopper on the swingarm.
2. Install the rear wheel and chain. Guide the brake disc between the brake pads. Make sure there is enough gap between the brake pads before inserting the brake disc.
3. Install the wheel axle and axle nut, and let the motorcycle down.



4. Adjust the drive chain. (See page 6-24 for adjusting the drive chain slack.)
5. Tighten the axle nut to the specified torque.

Tightening torque:

Axle nut:

104 Nm (10.4 m·kg)

## Troubleshooting

EAU01008

Although Yamaha motorcycles receive a rigid inspection before shipment from the factory, trouble may occur during operation.

Any problem in the fuel, compression, or ignition systems can cause poor starting and loss of power. The troubleshooting chart describes a quick, easy procedure for making checks.

If your motorcycle requires any repair, bring it to a Yamaha dealer. The skilled technicians at a Yamaha dealership have the tools, experience, and know-how to properly service your motorcycle. Use only genuine Yamaha parts on your motorcycle. Imitation parts may look like Yamaha parts, but they are often inferior. Consequently, they have a shorter service life and can lead to expensive repair bills.

# PERIODIC MAINTENANCE AND MINOR REPAIR

## Troubleshooting chart

EAU01581

EW000125

### **⚠WARNING**

**Never check the fuel system while smoking or in the vicinity of an open flame.**

### 1. Fuel

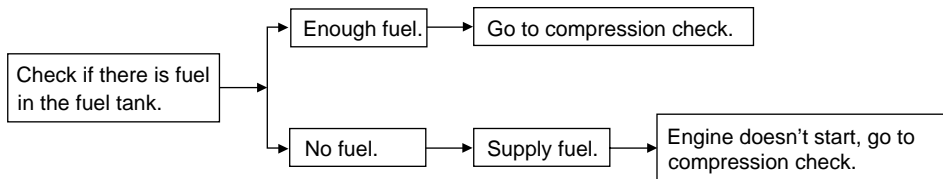

### 2. Compression

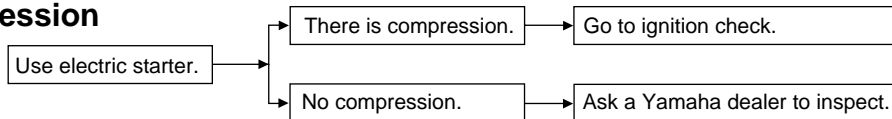

### 3. Ignition

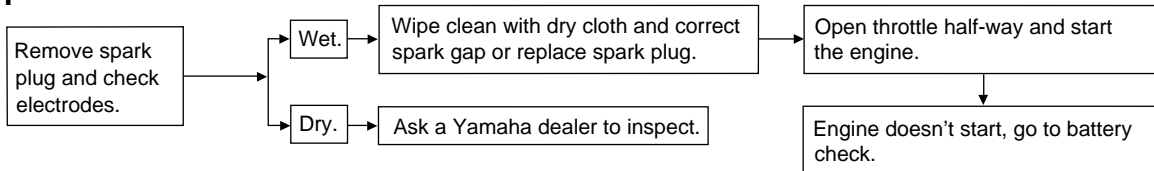

### 4. Battery

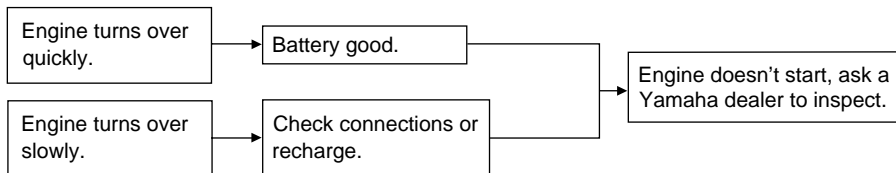

# PERIODIC MAINTENANCE AND MINOR REPAIR

## 5. Engine overheating

### **⚠ WARNING**

Do not remove the radiator cap when the engine and radiator are hot. Scalding hot fluid and steam may be blown out under pressure, which could cause serious injury. Open the radiator cap as follows. Wait until the engine has cooled. Remove the radiator cap stopper by removing the screw. Place a thick rag like a towel over the radiator cap and slowly rotate the cap counterclockwise to the detent. This procedure allows any residual pressure to escape. When the hissing sound has stopped, press down on the cap while turning counterclockwise and remove it.

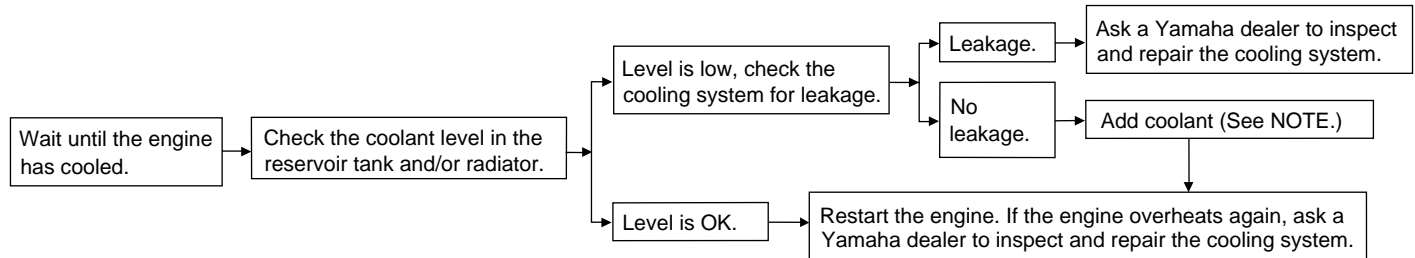

### **NOTE:**

If it is difficult to get the recommended coolant, tap water can be temporarily used, provided that it is changed to the recommended coolant as soon as possible.



# MOTORCYCLE CARE AND STORAGE

---

---

Care.....	7-1
Storage.....	7-4

# MOTORCYCLE CARE AND STORAGE

---

## Care

The exposure of its technology makes a motorcycle charming but also vulnerable. Although high-quality components are used, they are not all rust-resistant. While a rusty exhaust pipe may remain unnoticed on a car, it does look unattractive on a motorcycle. Frequent and proper care, however, will keep your motorcycle looking good, extend its life and maintain its performance. Moreover, the warranty states that the vehicle must be properly taken care of. For all these reasons, it is recommended that you observe the following cleaning and storing precautions.

## Before cleaning

1. Cover up the muffler outlet with a plastic bag.
2. Make sure that all caps and covers as well as all electrical couplers and connectors, including the spark plug cap, are tightly installed.
3. Remove extremely stubborn dirt, like oil burnt onto the crankcase, with a degreasing agent and a tooth or bottle brush, but never apply such products onto seals, gaskets, sprockets, the drive chain and wheel axles. Always rinse the dirt and degreaser off with water.

## Cleaning

### After normal use

Remove dirt with warm water, a neutral detergent and a soft clean sponge, then rinse with plenty of clean water. Use a brush for hard-to-reach parts. Tougher dirt and insects will come off more easily if the area is covered with a wet cloth for a few minutes before cleaning.

ECA00010

### **CAUTION:** \_\_\_\_\_

- **Avoid using strong acidic wheel cleaners, especially on spoked wheels. If you do use such products for hard-to-remove dirt, do not leave it on any longer than instructed, then thoroughly rinse it off with water, immediately dry the area and apply a corrosion protection spray.**

# MOTORCYCLE CARE AND STORAGE

---

- Improper cleaning can damage windshields, cowlings, panels and other plastic parts. Use only a soft, clean cloth or sponge with mild detergent and water to clean plastic.
  - Do not use any harsh chemical products on plastic parts. Be sure to avoid using cloths or sponges which have been in contact with strong or abrasive cleaning products, solvent or thinner, fuel (gasoline), rust removers or inhibitors, brake fluid, antifreeze or electrolyte.
  - Do not use high-pressure washers or steam-jet cleaners since they cause water seepage and deterioration in the following areas: seals (of wheel bearings, swingarm bearings, forks and brakes), electric components (couplers, connectors, instruments, switches and lights), breather hoses and vents.
  - For motorcycles equipped with a windshield: Do not use strong cleaners or hard sponges as they will cause dulling or scratching. Some cleaning compounds for plastic may leave scratches on the windshield. Test the product on a small hidden part of the windshield to make sure they do not leave any marks. If the windshield is scratched, use a quality plastic polishing compound after washing.
- 

After riding in the rain, near the sea or on salt-sprayed roads

Since sea salt or salt sprayed on the roads in the winter are extremely corrosive in combination with water, carry out the following steps after each ride in the rain, near the sea or on salt-sprayed roads. (Salt sprayed in the winter may remain on the roads well into spring.)

1. Clean your motorcycle with cold water and soap after the engine has cooled down.

ECA00012

**CAUTION:** \_\_\_\_\_

**Do not use warm water since it increases the corrosive action of the salt.**

---

2. Be sure to apply a corrosion protection spray on all (even chrome- and nickel-plated) metal surfaces to prevent corrosion.

# MOTORCYCLE CARE AND STORAGE

---

## After cleaning

1. Dry the motorcycle with a chamois or an absorbing cloth.
2. Immediately dry the drive chain and lubricate it to prevent it from rusting.
3. Use a chrome polish to shine chrome, aluminum and stainless-steel parts, including the exhaust system. (Even the thermally induced discoloring of stainless-steel exhaust systems can be removed through polishing.)
4. To prevent corrosion, it is recommended to apply a corrosion protection spray on all (even chrome- and nickel-plated) metal surfaces.
5. Use spray oil as a universal cleaner to remove any remaining dirt.
6. Touch up minor paint damage caused by stones, etc.
7. Wax all painted surfaces.
8. Let the motorcycle dry completely before storing it or covering it.

EWA00001

### **⚠ WARNING**

**Make sure that there is no oil or wax on the brakes and tires. If necessary, clean the brake discs and linings with a regular brake disc cleaner or acetone, and wash the tires with warm water and mild soap. Then, carefully test the motorcycle for its braking performance and cornering behavior.**

---

ECA000013

### **CAUTION:**

- **Apply spray oil and wax sparingly and wipe off any excess.**
  - **Never apply oil or wax on rubber and plastic parts, but treat them with a suitable care product.**
  - **Avoid using abrasive polishing compounds as they wear away the paint.**
- 

### **NOTE:**

Consult a Yamaha dealer for advice on what products to use.

---



## Storage

### Short-term

Always store your motorcycle in a cool, dry place and, if necessary, protect it against dust with a porous cover.

ECA00014

### CAUTION:

- **Storing the motorcycle in a poorly ventilated room or covering it with a tarp while it is still wet will allow water and humidity to seep in and cause rust.**
- **To prevent corrosion, avoid damp cellars, stables (because of the presence of ammonia) and areas where strong chemicals are stored.**

### Long-term

Before storing your motorcycle for several months:

1. Follow all the instructions in the “Care” section of this chapter.
2. Drain the carburetor float chamber by loosening the drain bolt; this will prevent fuel deposits from building up. Pour the drained fuel into the fuel tank.
3. Only for motorcycles equipped with a fuel cock which has an “OFF” position: Turn the fuel cock to “OFF”.
4. Fill up the fuel tank and add fuel stabilizer (if available) to prevent the fuel tank from rusting and the fuel from deteriorating.
5. Perform the following steps to protect the cylinder, piston rings, etc. from corrosion.

- a. Remove the spark plug cap and spark plug.
- b. Pour a teaspoonful of engine oil into the spark plug bore.
- c. Install the spark plug cap onto the spark plug and place the spark plug on the cylinder head so that the electrodes are grounded. (This will limit sparking during the next step.)
- d. Turn the engine over several times with the starter. (This will coat the cylinder wall with oil.)
- e. Remove the spark plug cap from the spark plug, install the spark plug and then the spark plug cap.

EWA00003

### **WARNING**

**When turning the engine over, be sure to ground the spark plug electrodes to prevent damage or injury from sparking.**

# MOTORCYCLE CARE AND STORAGE

---

6. Lubricate all control cables and the pivoting points of all levers and pedals as well as of the sidestand/centerstand.
7. Check and, if necessary, correct the tire air pressure, then raise the motorcycle so that both of its wheels are off the ground. Alternatively, turn the wheels a little every month in order to prevent the tires from becoming degraded in one spot.
8. Cover up the muffler outlet with a plastic bag to prevent moisture from entering.
9. Remove the battery and fully charge it. Store it in a cool, dry place and recharge it once a month. Do not store the battery in an excessively cold or warm place (less than 0°C or more than 30°C). For more information, see “Battery storage” in the chapter “PERIODIC MAINTENANCE AND MINOR REPAIRS”.

**NOTE:** \_\_\_\_\_  
Make any necessary repairs before storing the motorcycle.  
\_\_\_\_\_

Specifications .....	8-1
How to use the conversion table .....	8-5

# SPECIFICATIONS

## Specifications

<b>Model</b>	<b>TDR125</b>
<b>Dimensions</b>	
Overall length	2,120 mm (F, GB, IRL, B, P, GR, E) 2,185 mm (S, SF, D, CH, A)
Overall width	840 mm
Overall height	1,295 mm
Seat height	850 mm
Wheel base	1,405 mm
Ground clearance	270 mm
Minimum turning radius	2,200 mm
<b>Basic weight (with oil and full fuel tank)</b>	135 kg 136 kg (CH, A)
<b>Engine</b>	
Engine type	Liquid cooled 2-stroke, gasoline
Cylinder arrangement	Forward inclined single cylinder
Displacement	125 cm <sup>3</sup>
Bore × Stroke	56.0 × 50.7 mm
Compression ratio	6.6:1
Starting system	Electric starter
Lubrication system	Separate lubrication (Yamaha Autolube)

<b>Engine oil (2-cycle)</b>	
Type	Yamaha oil 2T or equivalent 2-stroke engine oil
Capacity	
Total amount	1.2 L
<b>Transmission oil</b>	
Type	SAE 10W30 SE motor oil
Capacity	
Periodic oil change	0.75 L
Total amount	0.8 L
<b>Radiator capacity</b>	
(Including all routes)	1.05 L
<b>Air filter</b>	Wet type element
<b>Fuel</b>	
Type	Regular unleaded gasoline
Fuel tank capacity	11 L
Reserve amount	2.2 L
<b>Carburetor</b>	
Type/quantity	TM28SS/1
Manufacturer	MIKUNI

## Spark plug

Type/Manufacturer	BR9ES/NGK
Spark plug gap	0.7 ~ 0.8 mm

## Clutch type

Wet, multiple-disc

## Transmission

Primary reduction system	Helical gear
Primary reduction ratio	71/22 (3.227)
Secondary reduction system	Chain drive
Secondary reduction ratio	57/16 (3.563)
Transmission type	Constant mesh 6-speed
Operation	Left foot operation
Gear ratio	1st 2.833
	2nd 1.875
	3rd 1.412
	4th 1.143
	5th 0.957
	6th 0.818

## Chassis

Frame type	Semi double cradle
Caster angle	26°
Trail	116 mm

## Tire

Type	Tubeless
Front	
Size	100/90-18 56P
Manufacturer/ model	BRIDGESTONE/TW53 DUNLOP/D602F
Rear	
Size	130/80-17 65P
Manufacturer/ model	BRIDGESTONE/TW54 DUNLOP/D602
Maximum load*	180 kg 179 kg (CH, A)
Air pressure (cold tire)	
up to 90 kg load*	
Front	175 kPa (1.75 kg/cm <sup>2</sup> , 1.75 bar)
Rear	200 kPa (2.00 kg/cm <sup>2</sup> , 2.00 bar)
90 kg load ~ Maximum load*	
Front	175 kPa (1.75 kg/cm <sup>2</sup> , 1.75 bar)
Rear	225 kPa (2.25 kg/cm <sup>2</sup> , 2.25 bar)

\* Load is total weight of cargo, rider, passenger and accessories.

# SPECIFICATIONS

---

---

## Wheels

### Front

Type	Cast wheel
Size	18 × MT2.15

### Rear

Type	Cast wheel
Size	17 × MT2.50

## Brakes

### Front

Type	Single disc brake
Operation	Right hand operation
Fluid	DOT 3 or DOT 4

### Rear

Type	Single disc brake
Operation	Right foot operation
Fluid	DOT 4

## Suspension

### Front

Type	Telescopic fork
------	-----------------

### Rear

Type	Swingarm (Monocross)
------	----------------------

## Shock absorber

### Front

Type	Coil spring/oil damper
------	------------------------

### Rear

Type	Coil-gas spring/oil damper
------	----------------------------

## Wheel travel

Front	180 mm
-------	--------

Rear	180 mm
------	--------

## Electrical

Ignition system	C.D.I.
-----------------	--------

### Charging system

Type	C.D.I. magneto
Standard output	14 V, 12A @5,000 r/min

### Battery

Type	YTX5L-BS
Voltage, capacity	12 V, 4 AH

## Headlight bulb type

Halogen bulb

## Bulb voltage, wattage × quantity

Headlight	12 V, 60/55W × 2
	12 V, 35/35W × 2 (GB, IRL only)

Stop/tail light	12 V, 21/5W × 2
Front flasher light	12 V, 21W × 2
Rear flasher light	12 V, 21W × 2
Auxiliary light	12 V, 4W × 2
	12 V, 3.4W × 2 (GB, IRL only)
Meter light	12 V, 3.4W × 3
Neutral indicator light	12 V, 3.4W × 1
High beam indicator light	12 V, 3.4W × 1
Oil level indicator light	12 V, 3.4W × 1
Turn indicator light	12 V, 3.4W × 1
<b>Fuse</b>	
Main	20A

# SPECIFICATIONS

EAU01064

## HOW TO USE THE CONVERSION TABLE

All specification data in this manual are listed in SI and METRIC UNITS.

Use this table to convert METRIC unit data to IMPERIAL unit data.

Ex.

METRIC		MULTIPLIER	=	IMPERIAL
** mm	×	0.03937	=	** in
2 mm	×	0.03937	=	0.08 in

## CONVERSION TABLE

METRIC TO IMPERIAL			
	Metric unit	Multiplier	Imperial unit
Torque	m • kg	7.233	ft • lb
	m • kg	86.794	in • lb
	cm • kg	0.0723	ft • lb
	cm • kg	0.8679	in • lb
Weight	kg	2.205	lb
	g	0.03527	oz
Speed	km/hr	0.6214	mph
Distance	km	0.6214	mi
	m	3.281	ft
	m	1.094	yd
	cm	0.3937	in
	mm	0.03937	in
Volume/ Capacity	cc (cm <sup>3</sup> )	0.03527	oz (IMP liq.)
	cc (cm <sup>3</sup> )	0.06102	cu • in
	lt (liter)	0.8799	qt (IMP liq.)
	lt (liter)	0.2199	gal (IMP liq.)
Misc.	kg/mm	55.997	lb/in
	kg/cm <sup>2</sup>	14.2234	psi (lb/in <sup>2</sup> )
	Centigrade(°C)	9/5 + 32	Fahrenheit(°F)



Identification number records .....	9-1
Key identification number .....	9-1
Vehicle identification number.....	9-1
Model label .....	9-2

# CONSUMER INFORMATION

EAU02944

## Identification number records

Record the key identification number, vehicle identification number and model label information in the spaces provided for assistance when ordering spare parts from a Yamaha dealer or for reference in case the vehicle is stolen.

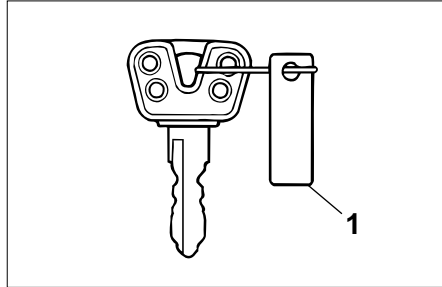

1. Key identification number

EAU01041

### Key identification number

The key identification number is stamped on the key tag. Record this number in the space provided and use it for reference when obtaining a new key.

1. KEY IDENTIFICATION NUMBER:

2. VEHICLE IDENTIFICATION NUMBER:

3. MODEL LABEL INFORMATION:

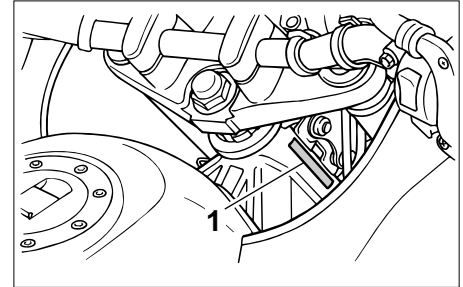

1. Vehicle identification number

EAU01043

### Vehicle identification number

The vehicle identification number is stamped into the steering head pipe. Record this number in the space provided.

**NOTE:** \_\_\_\_\_

The vehicle identification number is used to identify your motorcycle and may be used to register your motorcycle with the licensing authority in your state.

\_\_\_\_\_

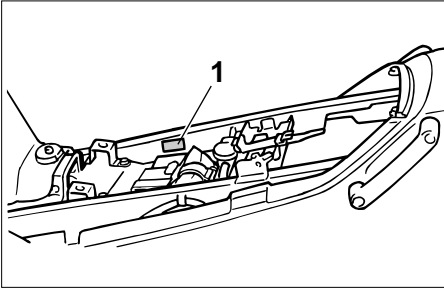

1. Model label

EAU01050

## Model label

The model label is affixed to the frame under the seat. (See page 3-13 for seat removal procedures.)

Record the information on this label in the space provided. This information will be needed to order spare parts from your Yamaha dealer.

# INDEX

- A**  
Air filter .....6-13  
Autolube pump adjustment.....6-26
- B**  
Battery .....6-29  
Brake and clutch lever lubrication .....6-27  
Brake and shift pedal lubrication .....6-26  
Brake fluid replacement.....6-23  
Brake light switch adjustment.....6-21
- C**  
Cable inspection and lubrication .....6-25  
Carburetor adjustment.....6-15  
Care.....7-1  
Catalyzer  
(for Switzerland and Austria) .....3-11  
Checking the front and rear brake  
pads .....6-21  
Clutch lever .....3-8  
Clutch lever free play adjustment .....6-19  
Controls/Instruments .....2-3  
Cooling system.....6-11  
Cowling A, B .....6-7  
Cowling and panel removal and  
installation .....6-6
- D**  
Description .....2-1  
Dimmer switch.....3-5  
Drive chain lubrication .....6-25  
Drive chain slack adjustment.....6-24  
Drive chain slack check.....6-23
- E**  
Engine break-in .....5-5
- Engine stop switch .....3-7  
Engine temperature gauge .....3-5
- F**  
Front brake lever .....3-8  
Front brake lever free play  
adjustment .....6-20  
Front fork inspection.....6-28  
Front wheel installation.....6-34  
Front wheel removal.....6-33  
Fuel .....3-10  
Fuel cock .....3-12  
Fuel tank cap.....3-9  
Fuse replacement.....6-30
- H**  
Handlebar switches .....3-5  
Dimmer switch .....3-5  
Engine stop switch .....3-7  
Headlight beam variation .....3-6  
Horn switch .....3-5  
Lights switch .....3-5  
Start switch .....3-7  
Turn signal switch .....3-5  
Headlight beam variation.....3-6  
Headlight bulb replacement.....6-31  
Helmet holder .....3-14  
High beam indicator light.....3-2  
Horn switch.....3-5  
How to use the conversion table .....8-5
- I**  
Identification number records .....9-1  
Idle speed adjustment .....6-15  
Indicator lights .....3-2  
High beam indicator light .....3-2
- Neutral indicator light .....3-2  
Oil level indicator light.....3-2  
Turn indicator light .....3-2  
Inspecting the brake fluid level .....6-22
- K**  
Key identification number .....9-1
- L**  
Lights switch .....3-5  
Left view .....2-1
- M**  
Main switch/Steering lock.....3-1  
Model level .....9-2
- N**  
Neutral indicator light.....3-2  
Note on handling of the Yamaha  
Energy Induction System (Y.E.I.S.) ....3-15
- O**  
Oil level indicator circuit check .....3-3  
Oil level indicator light .....3-2
- P**  
Panel A .....6-7  
Parking .....5-6  
Periodic maintenance and  
lubrication .....6-3  
Pre-operation check list.....4-1
- R**  
Rear brake pedal.....3-9  
Rear brake pedal height adjustment ....6-20  
Rear shock absorber adjustment .....3-14  
Rear suspension lubrication .....6-27  
Rear wheel installation .....6-35  
Rear wheel removal .....6-34

Recommended shift points (for Switzerland only) .....	5-5
Right view .....	2-2
<b>S</b>	
Seat .....	3-13
Shift pedal .....	3-8
Shifting .....	5-4
Sidestand .....	3-16
Sidestand lubrication .....	6-27
Sidestand/clutch switch operation check .....	3-17
Spark plug inspection .....	6-8
Specifications .....	8-1
Speedometer .....	3-4
Start switch .....	3-7
Starter (choke) "1" .....	3-13
Starting a warm engine .....	5-4
Starting the engine .....	5-1
Steering inspection .....	6-28
Storage .....	7-4
<b>T</b>	
Tachometer .....	3-4
Taillight bulb replacement .....	6-32
Throttle cable and grip lubrication .....	6-25
Throttle cable free play adjustment .....	6-16
Tips for reducing fuel consumption .....	5-5
Tires .....	6-17
Tool kit .....	6-1
Transmission oil .....	6-9
Troubleshooting .....	6-36
Troubleshooting chart .....	6-37
Turn indicator light .....	3-2
Turn signal light bulb replacement .....	6-32

Turn signal switch .....	3-5
Two-stroke engine oil .....	3-12
<b>V</b>	
Vehicle identification number .....	9-1
<b>W</b>	
Wheel bearings .....	6-29
Wheels .....	6-19
<b>Y</b>	
Y.P.V.S. (Yamaha Power Valve System) .....	3-16







PRINTED ON RECYCLED PAPER

PRINTED IN JAPAN  
99-8-0.1×1(E) 