



OWNER'S MANUAL  
MANUEL DU PROPRIÉTAIRE  
BEDIENUNGSANLEITUNG

**PW80**

**PW80(X)**

3RV-28199-8H

PRINTED ON RECYCLED PAPER  
IMPRIMÉ SUR PAPIER RECYCLÉ  
AUF RECYCLINGPAPIER GEDRUCKT



PRINTED IN JAPAN  
2007.4-0.7×1   
(E, F, G)



**OWNER'S MANUAL**

***PW80***

***PW80(X)***

**3RV-28199-8H-E0**



Congratulations on your purchase of the Yamaha PW80(X). This model is the result of Yamaha's vast experience in the production of fine sporting, touring, and pacesetter racing machines. It represents the high degree of craftsmanship and reliability that have made Yamaha a leader in these fields.

This manual will give you an understanding of the operation, inspection, and basic maintenance of this motorcycle. If you have any questions concerning the operation or maintenance of your motorcycle, please consult a Yamaha dealer.

The design and manufacture of this Yamaha motorcycle fully comply with the emissions standards for clean air applicable at the date of manufacture. Yamaha has met these standards without reducing the performance or economy of operation of the motorcycle. To maintain these high standards, it is important that you and your Yamaha dealer pay close attention to the recommended maintenance schedules and operating instructions contained within this manual.

## **AN IMPORTANT SAFETY MESSAGE:**

- READ THIS MANUAL CAREFULLY AND COMPLETELY BEFORE OPERATING THIS MOTORCYCLE. MAKE SURE YOU UNDERSTAND ALL INSTRUCTIONS.
- PAY CLOSE ATTENTION TO THE WARNING AND CAUTION LABELS ON THE MOTORCYCLE.
- NEVER OPERATE A MOTORCYCLE WITHOUT PROPER TRAINING OR INSTRUCTION.
- WEIGHT OF THE RIDER SHOULD NOT EXCEED 40 kg (88 lb).

## **AN IMPORTANT NOTE TO PARENTS:**

This motorcycle is not a toy. Before you let your child ride this motorcycle, you should understand the instructions and warnings in this Owner's Manual. Then be sure your child understands and will follow them. Children differ in skills, physical abilities, and judgment. Some children may not be able to operate a motorcycle safely. Parents should supervise their child's use of the motorcycle at all times. Parents should permit continued use only if they determine that the child has the ability to operate the motorcycle safely.

Your motorcycle was delivered with a removable power reduction plate. Yamaha recommends that all beginners start off with the power reduction plate installed to limit the engine power available while they learn. Parents should decide when to remove the power reduction plate from the motorcycle for more power as their youngster's riding skills improve. Once the rider can operate with skill at the top speed permitted by power reduction plate installed, the power reduction plate can be removed.

# **INTRODUCTION**

---

---

**MOTORCYCLES ARE SINGLE TRACK VEHICLES. THEIR SAFE USE AND OPERATION ARE DEPENDENT UPON THE USE OF PROPER RIDING TECHNIQUES AS WELL AS THE EXPERTISE OF THE OPERATOR. EVERY OPERATOR SHOULD KNOW THE FOLLOWING REQUIREMENTS BEFORE RIDING THIS MOTORCYCLE.**



HE OR SHE SHOULD:

- OBTAIN THOROUGH INSTRUCTIONS FROM A COMPETENT SOURCE ON ALL ASPECTS OF MOTORCYCLE OPERATION.
- OBSERVE THE WARNINGS AND MAINTENANCE REQUIREMENTS IN THE OWNER'S MANUAL.
- OBTAIN QUALIFIED TRAINING IN SAFE AND PROPER RIDING TECHNIQUES.
- OBTAIN PROFESSIONAL TECHNICAL SERVICE AS INDICATED BY THE OWNER'S MANUAL AND/OR WHEN MADE NECESSARY BY MECHANICAL CONDITIONS.

# IMPORTANT MANUAL INFORMATION

EAU41090

Particularly important information is distinguished in this manual by the following notations:

	<b>The Safety Alert Symbol means ATTENTION! BECOME ALERT! YOUR SAFETY IS INVOLVED!</b>
	<b>Failure to follow WARNING instructions <u>could result in severe injury or death</u> to the motorcycle operator, a bystander or a person inspecting or repairing the motorcycle.</b>
<b>CAUTION:</b>	<b>A CAUTION indicates special precautions that must be taken to avoid damage to the motorcycle.</b>
<b>NOTE:</b>	A NOTE provides key information to make procedures easier or clearer.

**NOTE:**

- This manual should be considered a permanent part of this motorcycle and should remain with it even if the motorcycle is subsequently sold.
- Yamaha continually seeks advancements in product design and quality. Therefore, while this manual contains the most current product information available at the time of printing, there may be minor discrepancies between your motorcycle and this manual. If you have any questions concerning this manual, please consult your Yamaha dealer.

# IMPORTANT MANUAL INFORMATION

---

---

EWA10030

## **WARNING**

**PLEASE READ THIS MANUAL CAREFULLY AND COMPLETELY BEFORE OPERATING THIS MOTORCYCLE.**

---

EWA14350

## **WARNING**

**THIS MOTORCYCLE IS DESIGNED AND MANUFACTURED FOR OFF-ROAD USE ONLY. IT IS ILLEGAL TO OPERATE THIS MOTORCYCLE ON ANY PUBLIC STREET, ROAD OR HIGHWAY. SUCH USE IS PROHIBITED BY LAW. THIS MOTORCYCLE COMPLIES WITH ALMOST ALL STATE OFF-HIGHWAY NOISE LEVEL AND SPARK ARRESTER LAWS AND REGULATIONS. PLEASE CHECK YOUR LOCAL RIDING LAWS AND REGULATIONS BEFORE OPERATING THIS MOTORCYCLE.**

---

\*Product and specifications are subject to change without notice.



# IMPORTANT MANUAL INFORMATION

---

EAU10200

**PW80(X)  
OWNER'S MANUAL  
©2007 by Yamaha Motor Co., Ltd.  
1st edition, March 2007  
All rights reserved.  
Any reprinting or unauthorized use  
without the written permission of  
Yamaha Motor Co., Ltd.  
is expressly prohibited.  
Printed in Japan.**

# TABLE OF CONTENTS

---

---

<b>SAFETY INFORMATION</b> .....	1-1	<b>OPERATION AND IMPORTANT</b>	
Safe riding .....	1-1	<b>RIDING POINTS</b> .....	5-1
Location of important labels .....	1-4	Starting and warming up a cold engine .....	5-1
<b>DESCRIPTION</b> .....	2-1	Starting a warm engine .....	5-2
Left view .....	2-1	Shifting .....	5-2
Right view .....	2-2	Engine break-in .....	5-3
Controls and instruments .....	2-3	Parking .....	5-4
<b>INSTRUMENT AND CONTROL</b>		<b>PERIODIC MAINTENANCE AND</b>	
<b>FUNCTIONS</b> .....	3-1	<b>MINOR REPAIR</b> .....	6-1
Handlebar switch .....	3-1	Owner's tool kit .....	6-1
Power reduction plate .....	3-1	Periodic maintenance and lubrication chart .....	6-2
Shift pedal .....	3-1	Checking the spark plug .....	6-5
Brake lever .....	3-2	Removing the power reduction plate .....	6-6
Brake pedal .....	3-2	Transmission oil .....	6-7
Fuel tank cap .....	3-2	Cleaning the air filter element .....	6-8
Fuel .....	3-3	Cleaning the spark arrester .....	6-9
Fuel tank breather hose .....	3-4	Adjusting the carburetor .....	6-10
2-stroke engine oil .....	3-4	Adjusting the engine idling speed .....	6-11
Fuel cock .....	3-5	Adjusting the throttle cable free play .....	6-11
Starter (choke) lever "1" .....	3-6	Tires .....	6-12
Kickstarter .....	3-6	Spoke wheels .....	6-13
Seat .....	3-6	Accessories and replacement parts .....	6-14
Shock absorber .....	3-7	Adjusting the brake lever free play .....	6-14
<b>PRE-OPERATION CHECKS</b> .....	4-1	Adjusting the brake pedal free play .....	6-15
Pre-operation check list .....	4-2	Checking the front and rear brake shoes .....	6-16
		Drive chain slack .....	6-16
		Cleaning and lubricating the drive chain .....	6-18
		Checking and lubricating the cables .....	6-19
		Checking and lubricating the throttle grip and cable .....	6-19
		Adjusting the Autolube pump .....	6-19
		Checking and lubricating the brake and shift pedals .....	6-20
		Checking and lubricating the brake lever .....	6-20
		Checking and lubricating the sidestand .....	6-21
		Checking the front fork .....	6-21
		Checking the steering .....	6-22
		Checking the wheel bearings .....	6-22
		Supporting the motorcycle .....	6-23
		Front wheel .....	6-23
		Rear wheel .....	6-26
		Troubleshooting .....	6-27
		Troubleshooting chart .....	6-28
		<b>MOTORCYCLE CARE AND</b>	
		<b>STORAGE</b> .....	7-1
		Matte color caution .....	7-1
		Care .....	7-1

# TABLE OF CONTENTS

---

---

Storage .....	7-3
<b>SPECIFICATIONS</b> .....	8-1
<b>CONSUMER INFORMATION</b> .....	9-1
Identification numbers .....	9-1

# SAFETY INFORMATION

EAU41211

## Safe riding

- Always make pre-operation checks. Careful checks may help prevent an accident.
- This motorcycle is designed for off-road use only, therefore, it is illegal to operate it on public streets, roads, or highways, even a dirt or gravel one. Off-road use on public lands may be illegal. Please check local regulations before riding.
- This motorcycle is designed to carry the operator only. No passengers.
- Many accidents involve inexperienced operators.
  - Make sure that the operator is qualified and that you only lend your motorcycle to other qualified operators.
  - Know your skills and limits. Staying within your limits may help you to avoid an accident.
- Many accidents have been caused by error of the motorcycle operator. A typical error made by the operator is veering wide on a turn due to EXCESSIVE SPEED or un-

dercornering (insufficient lean angle for the speed). Never travel faster than warranted by conditions.

- Ride cautiously in unfamiliar areas. You may encounter hidden obstacles that could cause an accident.
- The posture of the operator is important for proper control. The operator should keep both hands on the handlebar and both feet on the operator footrests during operation to maintain control of the motorcycle.
- Never ride under the influence of alcohol or other drugs.
- Be sure the transmission is in neutral before starting the engine.

## Protective apparel

The majority of fatalities from motorcycle accidents are the result of head injuries. The use of a safety helmet is the single most critical factor in the prevention or reduction of head injuries.

- Always wear an approved helmet.
- Wear a face shield or goggles.

Wind in your unprotected eyes could contribute to an impairment of vision that could delay seeing a hazard.

- The use of a jacket, heavy boots, trousers, gloves, etc., is effective in preventing or reducing abrasions or lacerations.
- Never wear loose-fitting clothes, otherwise they could catch on the control levers, footrests, or wheels and cause injury or an accident.
- Never touch the engine or exhaust system during or after operation. They become very hot and can cause burns. Always wear protective clothing that covers your legs, ankles, and feet.

## Modifications

Modifications made to this motorcycle not approved by Yamaha, or the removal of original equipment, may render the motorcycle unsafe for use and may cause severe personal injury. Modifications may also make your motorcycle illegal to use.

## Loading and accessories

Adding accessories to your motorcycle can adversely affect stability and handling if the weight distribution of the motorcycle is changed. To avoid the possibility of an accident, use extreme caution when adding accessories to your motorcycle. Use extra care when riding a motorcycle that has added accessories. Here are some general guidelines to follow if adding accessories to your motorcycle:

### Loading

- The weight of the operator must not exceed 40 kg (88 lb).
- Accessory weight should be kept as low and close to the motorcycle as possible. Make sure to distribute the weight as evenly as possible on both sides of the motorcycle to minimize imbalance or instability.
- Shifting weights can create a sudden imbalance. Make sure that accessories are securely attached to the motorcycle before riding. Check accessory mounts fre-

quently.

- Never attach any large or heavy items to the handlebar, front fork, or front fender.

### Accessories

Genuine Yamaha accessories have been specifically designed for use on this motorcycle. Since Yamaha cannot test all other accessories that may be available, you must personally be responsible for the proper selection, installation and use of non-Yamaha accessories. Use extreme caution when selecting and installing any accessories.

Keep these guidelines in mind for mounting accessories in addition to those provided under “Loading”.

- Never install accessories or that would impair the performance of your motorcycle. Carefully inspect the accessory before using it to make sure that it does not in any way reduce ground clearance or cornering clearance, limit suspension travel, steering travel or control operation.

- Accessories fitted to the handlebar or the front fork area can create instability due to improper weight distribution or aerodynamic changes. If accessories are added to the handlebar or front fork area, they must be as lightweight as possible and should be kept to a minimum.
- Bulky or large accessories may seriously affect the stability of the motorcycle due to aerodynamic effects. Wind may attempt to lift the motorcycle, or the motorcycle may become unstable in cross winds.
- Certain accessories can displace the operator from his or her normal riding position. This improper position limits the freedom of movement of the operator and may limit control ability, therefore, such accessories are not recommended.
- Use caution when adding electrical accessories. If electrical accessories exceed the capacity of the motorcycle’s electrical system an

# SAFETY INFORMATION

---

electric failure could result, which could cause a dangerous loss of engine power.

## 1 Gasoline and exhaust gas

- GASOLINE IS HIGHLY FLAMMABLE:
  - Always turn the engine off when refueling.
  - Take care not to spill any gasoline on the engine or exhaust pipe/muffler when refueling.
  - Never refuel while smoking or in the vicinity of an open flame.
- Never start the engine or let it run for any length of time in a closed area. The exhaust fumes are poisonous and may cause loss of consciousness and death within a short time. Always operate your motorcycle in an area that has adequate ventilation.
- Always turn the engine off before leaving the motorcycle unattended. When parking the motorcycle, note the following:
  - The engine and exhaust pipe/muffler may be hot, therefore,

park the motorcycle in a place where pedestrians or children are not likely to touch these hot areas.

- Do not park the motorcycle on a slope or soft ground, otherwise it may fall over.
- Do not park the motorcycle near a flammable source (e.g., a kerosene heater, or near an open flame), otherwise it could catch fire.
- When transporting the motorcycle in another vehicle, make sure that it is kept upright and that the fuel cock is turned to “OFF”. If the motorcycle should lean over, gasoline may leak out of the carburetor or fuel tank.
- If you should swallow any gasoline, inhale a lot of gasoline vapor, or allow gasoline to get into your eyes, see your doctor immediately. If any gasoline spills on your skin or clothing, immediately wash the affected area with soap and water and change your clothes.

## Location of important labels

Please read the following important labels carefully before operating this vehicle.

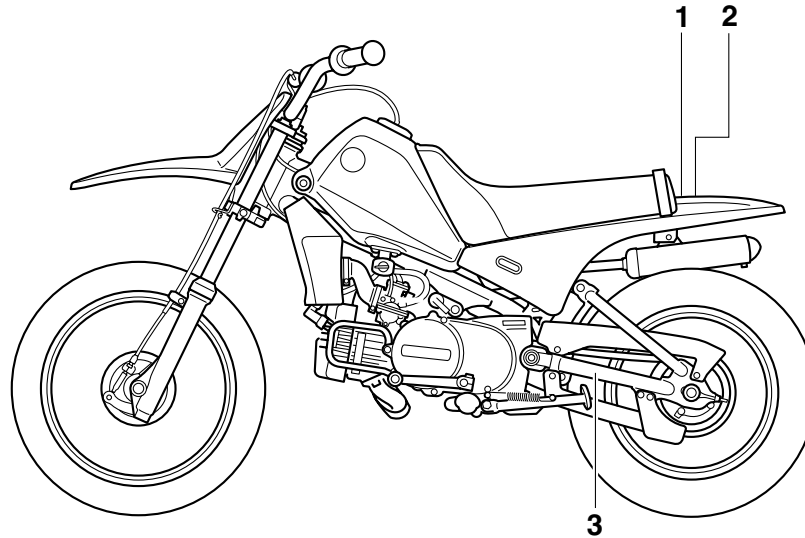

 **SAFETY INFORMATION**

---

1

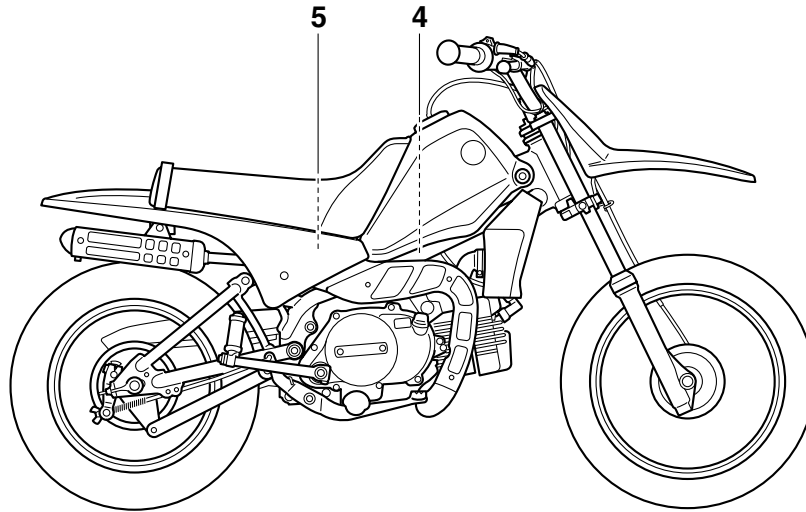





1



2

	
<ul style="list-style-type: none"><li>• Before you operate this vehicle, read the owner's manual.</li><li>• Prima di usare il veicolo, leggete il manuale di istruzioni.</li><li>• Lire le manuel du propriétaire avant d'utiliser ce véhicule.</li><li>• Lesen Sie die Bedienungsanleitung bevor Sie dieses Fahrzeug fahren.</li><li>• Antes de conducir este vehículo, lea el Manual del Propietario.</li></ul>	
<small>5PA-21568-00</small>	

3

<b>TIRE INFORMATION</b>
Cold tire normal pressure should be set as follows.
<b>FRONT</b> : 100 kPa, {1.00 kgf/cm <sup>2</sup> }, 15 psi
<b>REAR</b> : 100 kPa, {1.00 kgf/cm <sup>2</sup> }, 15 psi
<small>3RV-21688-A0</small>

4

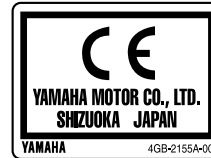

5



1

# DESCRIPTION

EAU10410

## Left view

2

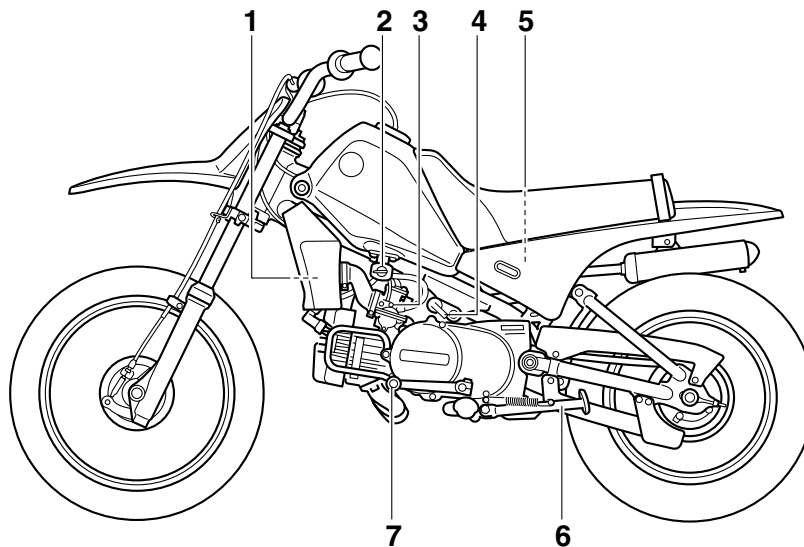

1. Air filter element (page 6-8)
2. Fuel cock (page 3-5)
3. Throttle stop screw (page 6-11)
4. Starter (choke) lever (page 3-6)
5. 2-stroke engine oil tank (page 3-4)
6. Sidestand (page 6-21)
7. Shift pedal (page 3-1)

## Right view

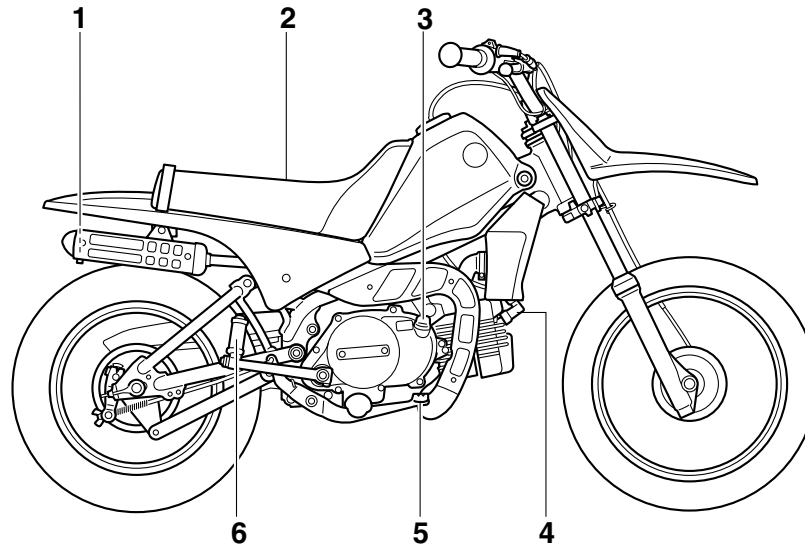

1. Spark arrester (page 6-9)
2. Seat (page 3-6)
3. Transmission oil filler cap (page 6-7)
4. Spark plug cap (page 6-5)
5. Brake pedal (page 3-2)
6. Kickstarter (page 3-6)

# DESCRIPTION

---

---

EAU10430

## Controls and instruments

2

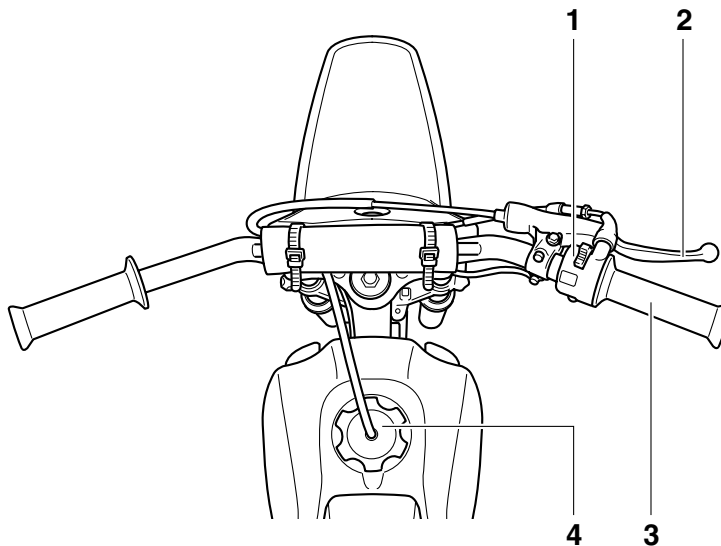

1. Right handlebar switch (page 3-1)
2. Brake lever (page 3-2)
3. Throttle grip (page 6-11)
4. Fuel tank cap (page 3-2)

# INSTRUMENT AND CONTROL FUNCTIONS

EAU40660

## Handlebar switch

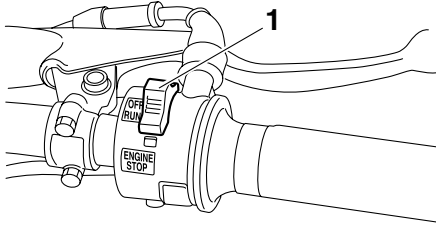

1. Engine stop switch "ENGINE STOP"

EAU41130

## Engine stop switch "ENGINE STOP"

Set this switch to "RUN" before starting the engine. Set this switch to "OFF" to stop the engine.

EAU41590

## Power reduction plate

Your motorcycle was delivered with a power reduction plate. Yamaha recommends that all beginning riders start off with the power reduction plate installed to limit the amount of power available while they learn.

Parents should decide when to adjust the motorcycle for more power as their youngster's riding skills improve. Once the rider can operate with skill at the top speed with the power reduction plate installed, the power reduction plate can be removed. (See page 6-6.)

EAU39850

## Shift pedal

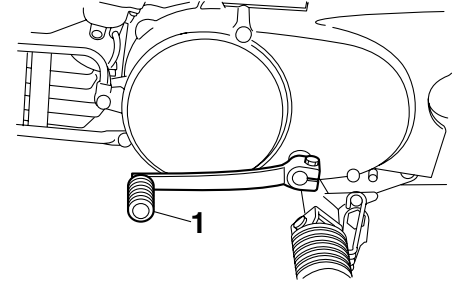

1. Shift pedal

This motorcycle is equipped with a constant-mesh 3-speed transmission. The shift pedal is located on the left side of the engine. Neutral is at the bottom position.

# INSTRUMENT AND CONTROL FUNCTIONS

## Brake lever

EAU12890

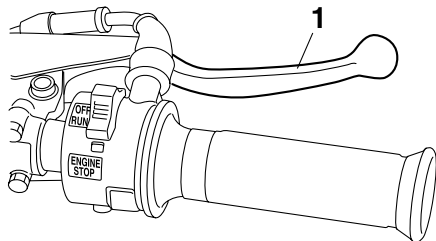

1. Brake lever

The brake lever is located at the right handlebar grip. To apply the front brake, pull the lever toward the handlebar grip.

## Brake pedal

EAU12941

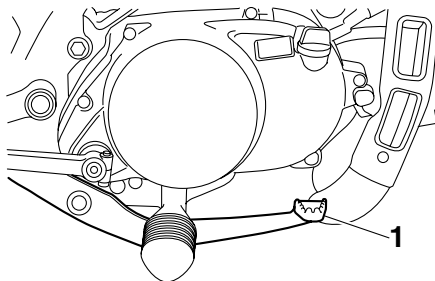

1. Brake pedal

The brake pedal is on the right side of the motorcycle. To apply the rear brake, press down on the brake pedal.

## Fuel tank cap

EAU13181

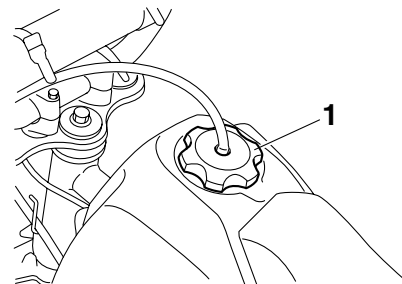

1. Fuel tank cap

To remove the fuel tank cap, turn it counterclockwise, and then pull it off. To install the fuel tank cap, insert it into the tank opening, and then turn it clockwise.

EWA11090

### **WARNING**

**Make sure that the fuel tank cap is properly closed before riding.**

# INSTRUMENT AND CONTROL FUNCTIONS

## Fuel

EAU13220

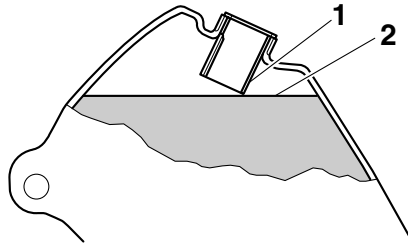

1. Fuel tank filler tube
2. Fuel level

Make sure that there is sufficient fuel in the tank. When refueling, be sure to insert the pump nozzle into the fuel tank filler hole and to fill the tank to the bottom of the filler tube as shown.

EWA10880

### WARNING

- Do not overfill the fuel tank, otherwise it may overflow when the fuel warms up and expands.
- Avoid spilling fuel on the hot engine.

ECA10070

### CAUTION:

Immediately wipe off spilled fuel with a clean, dry, soft cloth, since fuel may deteriorate painted surfaces or plastic parts.

EAU41960

### Recommended fuel:

For Europe: REGULAR UNLEADED GASOLINE ONLY

Except for Europe: UNLEADED GASOLINE ONLY

### Fuel tank capacity:

4.9 L (1.29 US gal) (1.08 Imp.gal)

### Fuel reserve amount:

1.0 L (0.26 US gal) (0.22 Imp.gal)

ECA15590

### CAUTION:

Use only unleaded gasoline. The use of leaded gasoline will cause severe damage to internal engine parts, such as the piston rings as well as to the exhaust system.

Your Yamaha engine has been designed to use regular unleaded gasoline with a research octane number of

91 or higher. If knocking (or pinging) occurs, use a gasoline of a different brand or premium unleaded fuel. Use of unleaded fuel will extend spark plug life and reduce maintenance costs.

# INSTRUMENT AND CONTROL FUNCTIONS

EAU13412

## Fuel tank breather hose

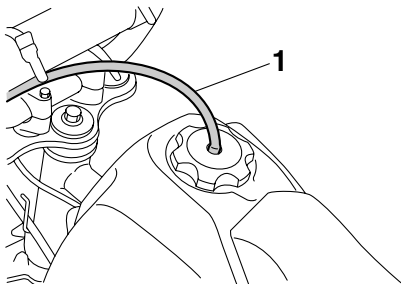

1. Fuel tank breather hose

Before operating the motorcycle:

- Check the fuel tank breather hose connection.
- Check the fuel tank breather hose for cracks or damage, and replace it if damaged.
- Make sure that the fuel tank breather hose is not blocked, and clean it if necessary.

EAU41201

## 2-stroke engine oil

Make sure that there is sufficient oil in the 2-stroke engine oil tank. If the 2-stroke engine oil is at or below the minimum level as shown in the illustration, add a sufficient amount of the recommended 2-stroke engine oil as follows.

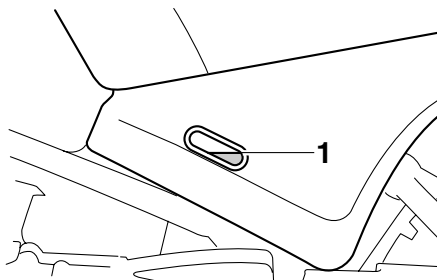

1. Minimum level

**NOTE:** \_\_\_\_\_  
Make sure that the motorcycle is positioned straight up when checking the 2-stroke engine oil level. A slight tilt to the side can result in a false reading.

1. Remove the seat. (See page 3-6.)
2. Remove the 2-stroke engine oil

tank cap and add the recommended oil.

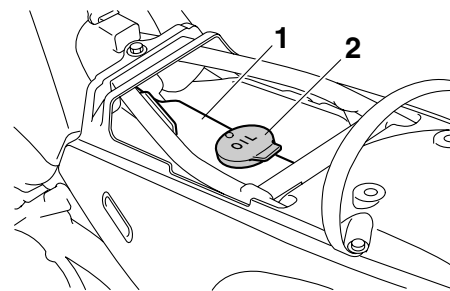

1. 2-stroke engine oil tank
2. 2-stroke engine oil tank cap

### Recommended oil:

See page 8-1.

### Oil quantity:

0.95 L (1.00 US qt) (0.84 Imp.qt)

3. Install the 2-stroke engine oil tank cap.

**NOTE:** \_\_\_\_\_  
Make sure that the 2-stroke engine oil tank cap is properly closed.

4. Install the seat.



# INSTRUMENT AND CONTROL FUNCTIONS

EAU13561

## Fuel cock

The fuel cock supplies fuel from the tank to the carburetor while filtering it also.

The fuel cock has three positions:

### OFF

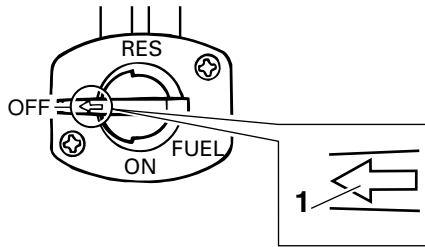

1. Arrow mark positioned over "OFF"

With the lever in this position, fuel will not flow. Always return the lever to this position when the engine is not running.

### ON

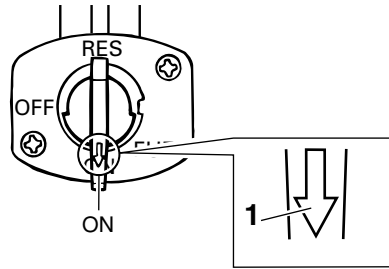

1. Arrow mark positioned over "ON"

With the lever in this position, fuel flows to the carburetor. Normal riding is done with the lever in this position.

### RES

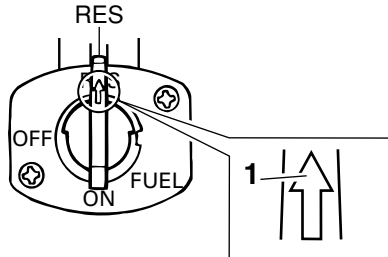

1. Arrow mark positioned over "RES"

This indicates reserve. If you run out of fuel while riding, move the lever to this position. Fill the tank at the first opportunity. Be sure to set the lever back to "ON" after refueling!

# INSTRUMENT AND CONTROL FUNCTIONS

EAU13590

## Starter (choke) lever “

1. Starter (choke) lever “

Starting a cold engine requires a richer air-fuel mixture, which is supplied by the starter (choke). Move the lever in direction (a) to turn on the starter (choke). Move the lever in direction (b) to turn off the starter (choke).

EAU13680

## Kickstarter

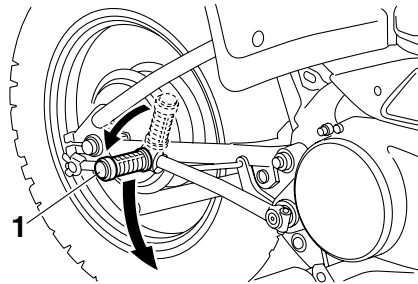

1. Kickstarter

To start the engine, fold out the kickstarter lever, move it down lightly with your foot until the gears engage, and then push it down smoothly but forcefully.

EAU41140

## Seat

### To remove the seat

Remove the nuts, and then pull the seat off.

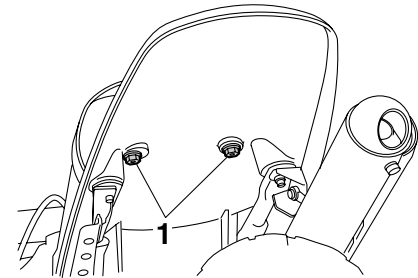

1. Nut

### To install the seat

1. Insert the projection on the front of the seat into the seat holder as shown.

EAU15090

EWA10220

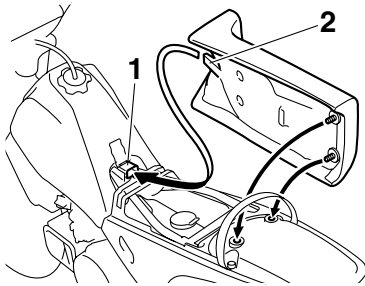

1. Seat holder
2. Projection

2. Place the seat in the original position, and then tighten the nuts.

**NOTE:** \_\_\_\_\_  
Make sure that the seat is properly secured before riding.

---

## Shock absorber

### **⚠ WARNING**

This shock absorber contains highly pressurized nitrogen gas. For proper handling, read and understand the following information before handling the shock absorber. The manufacturer cannot be held responsible for property damage or personal injury that may result from improper handling.

- Do not tamper with or attempt to open the gas cylinder.
  - Do not subject the shock absorber to an open flame or other high heat sources, otherwise it may explode due to excessive gas pressure.
  - Do not deform or damage the gas cylinder in any way, as this will result in poor damping performance.
  - Always have a Yamaha dealer service the shock absorber.
-

# PRE-OPERATION CHECKS

---

---

EAU15593

The condition of a vehicle is the owner's responsibility. Vital components can start to deteriorate quickly and unexpectedly, even if the vehicle remains unused (for example, as a result of exposure to the elements). Any damage, fluid leakage or loss of tire air pressure could have serious consequences. Therefore, it is very important, in addition to a thorough visual inspection, to check the following points before each ride.

**NOTE:** \_\_\_\_\_

Pre-operation checks should be made each time the vehicle is used. Such an inspection can be accomplished in a very short time; and the added safety it assures is more than worth the time involved.

---

EWA11150

** WARNING** \_\_\_\_\_

4

**If any item in the Pre-operation check list is not working properly, have it inspected and repaired before operating the vehicle.**

---

# PRE-OPERATION CHECKS

EAU15605

## Pre-operation check list

ITEM	CHECKS	PAGE
<b>Fuel</b>	<ul style="list-style-type: none"><li>• Check fuel level in fuel tank.</li><li>• Refuel if necessary.</li><li>• Check fuel line for leakage.</li></ul>	3-3
<b>2-stroke engine oil</b>	<ul style="list-style-type: none"><li>• Check oil level in oil tank.</li><li>• If necessary, add recommended oil to specified level.</li><li>• Check vehicle for oil leakage.</li></ul>	3-4
<b>Transmission oil</b>	<ul style="list-style-type: none"><li>• Check oil level in transmission case.</li><li>• If necessary, add recommended oil to specified level.</li></ul>	6-7
<b>Front brake</b>	<ul style="list-style-type: none"><li>• Check operation.</li><li>• Lubricate cable if necessary.</li><li>• Check lever free play.</li><li>• Adjust if necessary.</li></ul>	6-14, 6-16
<b>Rear brake</b>	<ul style="list-style-type: none"><li>• Check operation.</li><li>• Check pedal free play.</li><li>• Adjust if necessary.</li></ul>	6-15, 6-16
<b>Throttle grip</b>	<ul style="list-style-type: none"><li>• Make sure that operation is smooth.</li><li>• Check cable free play.</li><li>• If necessary, have Yamaha dealer adjust cable free play and lubricate cable and grip housing.</li></ul>	6-11, 6-19
<b>Control cables</b>	<ul style="list-style-type: none"><li>• Make sure that operation is smooth.</li><li>• Lubricate if necessary.</li></ul>	6-19
<b>Drive chain</b>	<ul style="list-style-type: none"><li>• Check chain slack.</li><li>• Adjust if necessary.</li><li>• Check chain condition.</li><li>• Lubricate if necessary.</li></ul>	6-16, 6-18
<b>Wheels and tires</b>	<ul style="list-style-type: none"><li>• Check for damage.</li><li>• Check tire condition and tread depth.</li><li>• Check air pressure.</li><li>• Correct if necessary.</li></ul>	6-12, 6-13

# PRE-OPERATION CHECKS

ITEM	CHECKS	PAGE
<b>Brake and shift pedals</b>	<ul style="list-style-type: none"><li>• Make sure that operation is smooth.</li><li>• Lubricate pedal pivoting points if necessary.</li></ul>	6-20
<b>Brake lever</b>	<ul style="list-style-type: none"><li>• Make sure that operation is smooth.</li><li>• Lubricate lever pivoting point if necessary.</li></ul>	6-20
<b>Sidestand</b>	<ul style="list-style-type: none"><li>• Make sure that operation is smooth.</li><li>• Lubricate pivot if necessary.</li></ul>	6-21
<b>Chassis fasteners</b>	<ul style="list-style-type: none"><li>• Make sure that all nuts, bolts and screws are properly tightened.</li><li>• Tighten if necessary.</li></ul>	—
<b>Engine stop switch</b>	<ul style="list-style-type: none"><li>• Check operation.</li></ul>	3-1

# OPERATION AND IMPORTANT RIDING POINTS

EAU41680

EWA14620

## **WARNING**

- This model is designed for off-road use only. Become thoroughly familiar with all operating controls and their functions before riding. Consult a Yamaha dealer regarding any control or function that you do not thoroughly understand.
- Never start the engine or operate it in a closed area for any length of time. Exhaust fumes are poisonous, and inhaling them can cause loss of consciousness and death within a short time. Always make sure that there is adequate ventilation.
- Before starting out, make sure that the sidestand is up. If the sidestand is not raised completely, it could contact the ground and distract the operator, resulting in a possible loss of control.

EAU41151

## Starting and warming up a cold engine

1. Turn the fuel cock lever to "ON".
2. Set the engine stop switch to "RUN".
3. Shift the transmission into the neutral position.

EWA14410

## **WARNING**

- Be sure to shift the transmission into neutral before starting the engine.
- Never ride with the sidestand down.

4. Turn the starter (choke) on and completely close the throttle. (See page 3-6.)
5. Start the engine by pushing the kickstarter lever down.
6. After starting the engine, move the starter (choke) back halfway.

ECA11130

## **CAUTION:**

For maximum engine life, always warm the engine up before starting off. Never accelerate hard when the engine is cold!

7. When the engine is warm, turn the starter (choke) off.

## **NOTE:**

The engine is warm when it responds normally to the throttle with the starter (choke) turned off.

# OPERATION AND IMPORTANT RIDING POINTS

EAU16660

## Starting a warm engine

Follow the same procedure as for starting a cold engine with the exception that the starter (choke) is not required when the engine is warm. Instead, start the engine with the throttle slightly open.

### NOTE:

If the engine does not start after several kicks, try again with the throttle 1/4 to 1/2 open.

EAU39901

## Shifting

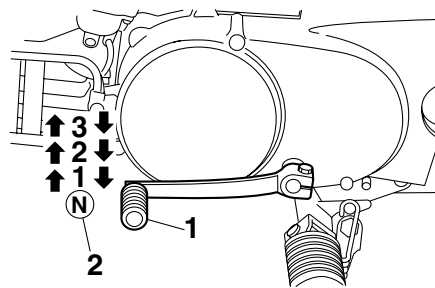

1. Shift pedal
2. Neutral position

This motorcycle has a 3-speed transmission with a centrifugal, automatic clutch. Shifting gears lets you control the amount of engine power available for starting off, accelerating, climbing hills, etc.

The gear positions are shown in the illustration.

### NOTE:

To shift the transmission into the neutral position, press the shift pedal down repeatedly until it reaches the end of its travel.

ECA15441

### CAUTION:

- Even with the transmission in the neutral position, do not coast for long periods of time with the engine off, and do not tow the motorcycle for long distances. The transmission is properly lubricated only when the engine is running. Inadequate lubrication may damage the transmission.
- Always release the throttle grip before changing gears to avoid damaging the engine, transmission, and drive train, which are not designed to withstand the shock of shifting when the throttle grip is open.

EAU39910

### To start out and accelerate

1. Close the throttle.
2. Shift into first gear and release the shift pedal.

ECA15460

### CAUTION:

Always close the throttle before



# OPERATION AND IMPORTANT RIDING POINTS

**shifting gears, otherwise damage to the engine and drive train may result.**

3. Open the throttle gradually.
4. Once the motorcycle has reached a speed high enough to change gears, close the throttle.
5. Shift into second gear and release the shift pedal.
6. Open the throttle gradually.
7. Follow the same procedure when shifting to the next higher gear.

EAU16710

## **To decelerate**

1. Close the throttle and apply both the front and the rear brakes to slow the motorcycle.
2. Downshift through the gears and shift the transmission into the neutral position when the motorcycle is almost completely stopped.

EAU39920

## **Engine break-in**

There is never a more important period in the life of your engine than the first 5 hours of riding. It is also important to acustom the rider to the motorcycle during this time. Please read the following information carefully.

Since the engine is brand new, do not put an excessive load on it for the first 5 hours of operation. The various parts in the engine wear and polish themselves to the correct operating clearances. During this period, prolonged full-throttle operation or any condition that might result in engine overheating must be avoided. However, momentary full-throttle operation under load (i.e., two to three seconds maximum) does not harm the engine. Each full-throttle acceleration should be followed with a substantial rest period for the engine. To allow the engine to cool down from the temporary buildup of heat, cruise at a lower engine speed.

After the first 5 hours of operation, thoroughly check the motorcycle for loose parts, oil leakage and any other problems. Be sure to inspect and make ad-

justments thoroughly, especially cable and drive chain slack and loose spokes. In addition, check all fittings and fasteners for looseness, and tighten if necessary.

ECA10270

## **CAUTION:**

**If any engine trouble should occur during the engine break-in period, immediately have a Yamaha dealer check the vehicle.**

# OPERATION AND IMPORTANT RIDING POINTS

---

---

EAU17190

## Parking

When parking, stop the engine, and then turn the fuel cock lever to “OFF”.

EWA10310

### **WARNING**

- Since the engine and exhaust system can become very hot, park in a place where pedestrians or children are not likely to touch them.
- Do not park on a slope or on soft ground, otherwise the vehicle may overturn.

# PERIODIC MAINTENANCE AND MINOR REPAIR

EAU41950

EAU17320

Safety is an obligation of the owner. Periodic inspection, adjustment and lubrication will keep your vehicle in the safest and most efficient condition possible. The most important points of motorcycle inspection, adjustment, and lubrication are explained on the following pages.

**Maintenance, replacement, or repair of the emission control devices and systems may be performed by any repair establishment or individual that is certified (if applicable).**

EWA10320



**If you are not familiar with maintenance work, have a Yamaha dealer do it for you.**

## Owner's tool kit

The service information included in this manual and the tools provided in the owner's tool kit are intended to assist you in the performance of preventive maintenance and minor repairs. However, additional tools such as a torque wrench may be necessary to perform certain maintenance work correctly.

**NOTE:** \_\_\_\_\_

If you do not have the tools or experience required for a particular job, have a Yamaha dealer perform it for you.

EWA10350



**Modifications not approved by Yamaha may cause loss of performance and render the vehicle unsafe for use. Consult a Yamaha dealer before attempting any changes.**

# PERIODIC MAINTENANCE AND MINOR REPAIR

EAU41763

## Periodic maintenance and lubrication chart

### NOTE:

- From 160 hours, repeat the maintenance intervals starting from 40 hours.
- Items marked with an asterisk should be performed by a Yamaha dealer as they require special tools, data and technical skills.

NO.	ITEM	CHECK OR MAINTENANCE JOB	INITIAL				THEREAFTER EVERY			
			10 hours	20 hours	40 hours	80 hours	40 hours	80 hours	160 hours	
1	*	<b>Fuel line</b>	● Check fuel hoses for cracks or damage. ● Replace if necessary.	√		√		√		
2		<b>Spark plug</b>	● Check condition. ● Adjust gap and clean. ● Replace if necessary.	√	√	√		√		
3		<b>Air filter element</b>	● Clean with solvent. ● Replace if necessary.		√	√	√	√		
4	*	<b>Clutch</b>	● Check operation. ● Adjust if necessary.		√	√		√		
5	*	<b>Front brake</b>	● Check operation. ● Adjust brake lever free play.		√	√		√		
			● Replace brake shoes.	Whenever worn to the limit						
6	*	<b>Rear brake</b>	● Check operation. ● Adjust brake pedal free play.		√	√		√		
			● Replace brake shoes.	Whenever worn to the limit						
7	*	<b>Wheels</b>	● Check runout, spoke tightness and for damage. ● Tighten spokes if necessary.	√	√	√		√		

# PERIODIC MAINTENANCE AND MINOR REPAIR

NO.	ITEM	CHECK OR MAINTENANCE JOB	INITIAL				THEREAFTER EVERY			
			10 hours	20 hours	40 hours	80 hours	40 hours	80 hours	160 hours	
8	*	<b>Tires</b>	<ul style="list-style-type: none"> <li>• Check tread depth and for damage.</li> <li>• Replace if necessary.</li> <li>• Check air pressure.</li> <li>• Correct if necessary.</li> </ul>	√	√	√		√		
9	*	<b>Wheel bearings</b>	<ul style="list-style-type: none"> <li>• Check bearings for smooth operation.</li> <li>• Replace if necessary.</li> </ul>				√	√	√	
10	*	<b>Steering bearings</b>	<ul style="list-style-type: none"> <li>• Check bearing assemblies for looseness.</li> <li>• Moderately repack with lithium-soap-based grease.</li> </ul>				√			√
11		<b>Drive chain</b>	<ul style="list-style-type: none"> <li>• Check chain slack/alignment and condition.</li> <li>• Adjust and lubricate chain with Yamaha chain and cable lube thoroughly.</li> </ul>	Every ride						
			<ul style="list-style-type: none"> <li>• Remove and clean.</li> </ul>			√		√		
12	*	<b>Chassis fasteners</b>	<ul style="list-style-type: none"> <li>• Check all chassis fitting and fasteners.</li> <li>• Correct if necessary.</li> </ul>	√	√	√	√	√		
13		<b>Sidestand pivot</b>	<ul style="list-style-type: none"> <li>• Check operation.</li> <li>• Apply lithium-soap-based grease (all-purpose grease) lightly.</li> </ul>			√			√	
14	*	<b>Front fork</b>	<ul style="list-style-type: none"> <li>• Check operation and for oil leakage.</li> <li>• Replace if necessary.</li> </ul>				√		√	
15	*	<b>Shock absorber assembly</b>	<ul style="list-style-type: none"> <li>• Check operation and for oil leakage.</li> <li>• Replace if necessary.</li> </ul>				√		√	
16	*	<b>Carburetor</b>	<ul style="list-style-type: none"> <li>• Check engine idling speed and starter operation.</li> </ul>		√	√	√		√	
			<ul style="list-style-type: none"> <li>• Clean.</li> <li>• Replace if necessary.</li> </ul>							√

# PERIODIC MAINTENANCE AND MINOR REPAIR

NO.	ITEM	CHECK OR MAINTENANCE JOB	INITIAL				THEREAFTER EVERY		
			10 hours	20 hours	40 hours	80 hours	40 hours	80 hours	160 hours
17	* Autolube pump	<ul style="list-style-type: none"> <li>• Check operation.</li> <li>• Correct if necessary.</li> <li>• Bleed.</li> </ul>	√	√	√		√		
18	Transmission oil	<ul style="list-style-type: none"> <li>• Check for oil leakage.</li> <li>• Correct if necessary.</li> <li>• Change.</li> </ul>		√	√			√	
19	* Control cables	<ul style="list-style-type: none"> <li>• Apply Yamaha chain and cable lube or engine oil 10W-30 lightly.</li> </ul>			√	√		√	
20	* Throttle grip housing and cable	<ul style="list-style-type: none"> <li>• Check operation and free play.</li> <li>• Apply Yamaha chain and cable lube or engine oil 10W-30 lightly.</li> </ul>	√	√	√		√		
21	Brake lever pivot shaft	<ul style="list-style-type: none"> <li>• Apply lithium-soap-based grease (all-purpose grease) lightly.</li> </ul>			√			√	
22	Brake pedal pivot shaft	<ul style="list-style-type: none"> <li>• Apply lithium-soap-based grease (all-purpose grease) lightly.</li> </ul>			√			√	
23	* Cylinder head and exhaust system	<ul style="list-style-type: none"> <li>• Check for leakage.</li> <li>• Tighten if necessary.</li> <li>• Decarbonize if necessary.</li> </ul>			√			√	
24	* Spark arrester	<ul style="list-style-type: none"> <li>• Clean.</li> </ul>			√		√		

## NOTE:

The air filter needs more frequent service if you are riding in unusually wet or dusty areas.

# PERIODIC MAINTENANCE AND MINOR REPAIR

EAU19603

## Checking the spark plug

The spark plug is an important engine component, which is easy to check. Since heat and deposits will cause any spark plug to slowly erode, the spark plug should be removed and checked in accordance with the periodic maintenance and lubrication chart. In addition, the condition of the spark plug can reveal the condition of the engine.

### To remove the spark plug

1. Remove the spark plug cap.

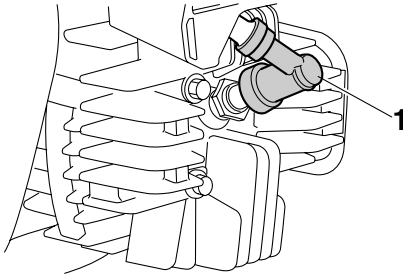

1. Spark plug cap

2. Remove the spark plug as shown, with the spark plug wrench included in the owner's tool kit.

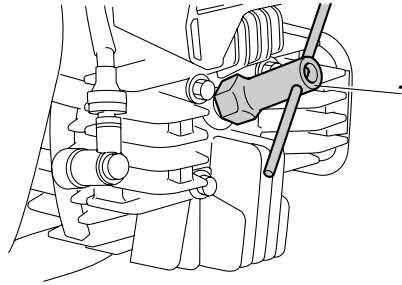

1. Spark plug wrench

### To check the spark plug

1. Check that the porcelain insulator around the center electrode of the spark plug is a medium-to-light tan (the ideal color when the vehicle is ridden normally).

#### NOTE:

If the spark plug shows a distinctly different color, the engine could be operating improperly. Do not attempt to diagnose such problems yourself. Instead, have a Yamaha dealer check the vehicle.

2. Check the spark plug for electrode erosion and excessive carbon or

other deposits, and replace it if necessary.

#### Specified spark plug:

NGK/BP6HS (AUS)(NZL)  
NGK/BPR6HS  
(AUT)(BEL)(CHE)(DEU)(DNK)  
(ESP)(FIN)(FRA)(GBR)(GRC)(IRL)  
(NLD)(NOR)(PRT)(SWE)(ZAF)  
DENSO/W20FP (AUS)(NZL)

### To install the spark plug

1. Measure the spark plug gap with a wire thickness gauge and, if necessary, adjust the gap to specification.

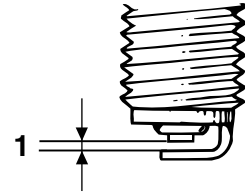

1. Spark plug gap

# PERIODIC MAINTENANCE AND MINOR REPAIR

## Spark plug gap:

0.6–0.7 mm (0.024–0.028 in)

2. Clean the surface of the spark plug gasket and its mating surface, and then wipe off any grime from the spark plug threads.
3. Install the spark plug with the spark plug wrench, and then tighten it to the specified torque.

## Tightening torque:

Spark plug:

25 Nm (2.5 m·kgf, 18.1 ft·lbf)

## NOTE:

If a torque wrench is not available when installing a spark plug, a good estimate of the correct torque is 1/4–1/2 turn past finger tight. However, the spark plug should be tightened to the specified torque as soon as possible.

4. Install the spark plug cap.

## Removing the power reduction plate

To obtain full engine performance capability, removing the power reduction plate is required.



**Always let the exhaust system cool prior to touching exhaust components.**

1. Remove the exhaust manifold by removing the bolts.

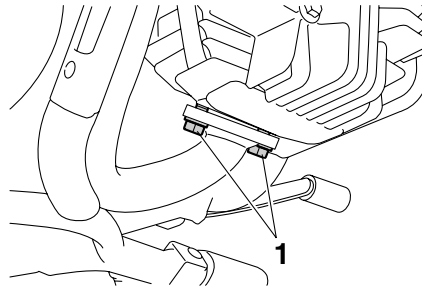

1. Exhaust manifold bolt
2. Remove the gasket.
3. Remove the power reduction plate.

EAU41100

EWA14580

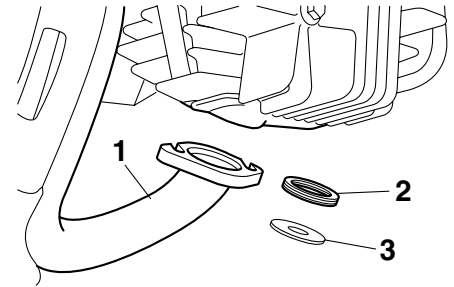

1. Exhaust manifold
2. Gasket
3. Power reduction plate

## NOTE:

Store the power reduction plate with the owner's manual so that it is readily available whenever you want to reduce the engine power.

4. Install the exhaust manifold by installing the bolts.

## Tightening torque:

Exhaust manifold bolt:

18 Nm (1.8 m·kgf, 13.0 ft·lbf)



# PERIODIC MAINTENANCE AND MINOR REPAIR

EAU19942

## Transmission oil

The transmission oil level should be checked before each ride. In addition, the transmission oil must be changed at the intervals specified in the periodic maintenance and lubrication chart.

### To check the transmission oil level

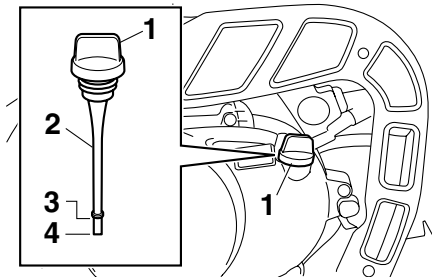

1. Transmission oil filler cap
2. Dipstick
3. Maximum level mark
4. Minimum level mark

1. Place the vehicle on a level surface and hold it in an upright position.

### NOTE:

Make sure that the vehicle is positioned

straight up when checking the oil level. A slight tilt to the side can result in a false reading.

2. Wait a few minutes until the oil settles, remove the oil filler cap, wipe the dipstick clean, insert it back into the oil filler hole (without screwing it in), and then remove it again to check the oil level.

### NOTE:

The transmission oil should be between the minimum and maximum level marks.

3. If the oil is below the minimum level mark, add sufficient oil of the recommended type to raise it to the correct level.
4. Insert the dipstick into the oil filler hole, and then tighten the oil filler cap.

### To change the transmission oil

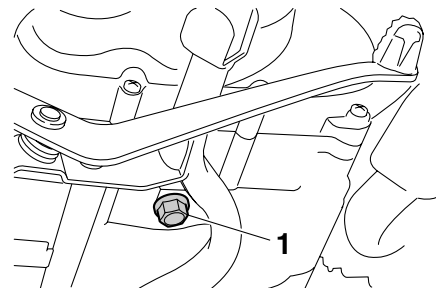

1. Transmission oil drain bolt

1. Place an oil pan under the transmission to collect the used oil.
2. Remove the oil filler cap and drain bolt to drain the oil from the transmission.
3. Install the transmission oil drain bolt, and then tighten it to the specified torque.

### Tightening torque:

Transmission oil drain bolt:  
20 Nm (2.0 m·kgf, 14.5 ft·lbf)

4. Add the specified amount of the recommended transmission oil, and then install and tighten the oil filler cap.

# PERIODIC MAINTENANCE AND MINOR REPAIR

## Recommended transmission oil:

See page 8-1.

## Oil change quantity:

0.65 L (0.69 US qt) (0.57 Imp.qt)

ECA10452

## CAUTION:

- In order to prevent clutch slippage (since the transmission oil also lubricates the clutch), do not mix any chemical additives. Do not use oils with a diesel specification of “CD” or oils of a higher quality than specified. In addition, do not use oils labeled “ENERGY CONSERVING II” or higher.
- Make sure that no foreign material enters the transmission.

5. Start the engine, and then let it idle for several minutes while checking the transmission for oil leakage. If oil is leaking, immediately turn the engine off and check for the cause.

EAU41161

## Cleaning the air filter element

The air filter element should be cleaned at the intervals specified in the periodic maintenance and lubrication chart. Clean the air filter element more frequently if you are riding in unusually wet or dusty areas.

1. Remove the air filter case cover by removing the screws.

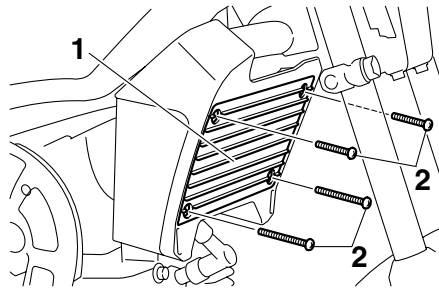

1. Air filter case cover
2. Screw

2. Pull the air filter element out.

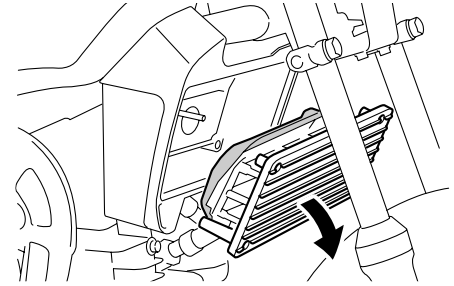

3. Remove the sponge material from the air filter case cover, clean it with solvent, and then squeeze the remaining solvent out.

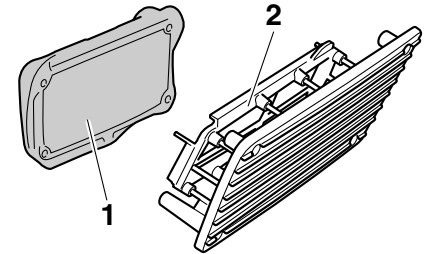

1. Sponge material
2. Air filter case cover

# PERIODIC MAINTENANCE AND MINOR REPAIR

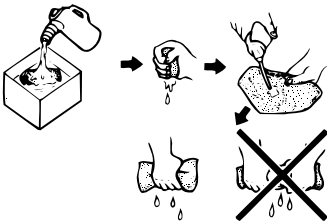

4. Apply oil of the recommended type to the entire surface of the sponge material, and then squeeze the excess oil out.

**NOTE:** \_\_\_\_\_

The sponge material should be wet but not dripping.

**Recommended oil:**

Yamaha foam air filter oil or other quality foam air filter oil

5. Install the sponge material onto the air filter case cover.
6. Insert the air filter element into the air filter case.

EGA10480

**CAUTION:** \_\_\_\_\_

- Make sure that the air filter ele-

ment is properly seated in the air filter case.

- The engine should never be operated without the air filter element installed, otherwise the piston(s) and/or cylinder(s) may become excessively worn.

7. Install the air filter case cover by installing the screws.

EAU41230

## Cleaning the spark arrester

The spark arrester should be cleaned at the intervals specified in the periodic maintenance and lubrication chart.

EWA10980

**WARNING**

- Always let the exhaust system cool prior to touching exhaust components.
- Do not start the engine when cleaning the exhaust system.

**NOTE:** \_\_\_\_\_

Make sure to select a well-ventilated area free of combustible materials to clean the spark arrester.

1. Remove the tailpipe by removing the bolt, and then pulling it out of the muffler.

# PERIODIC MAINTENANCE AND MINOR REPAIR

EAU39930

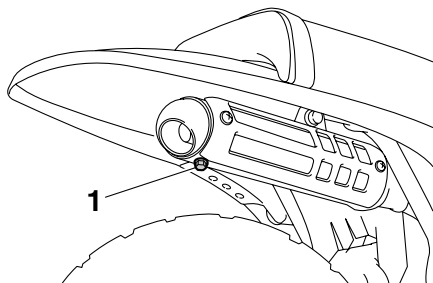

1. Bolt

2. Tap the tailpipe lightly, and then use a wire brush to remove any carbon deposits from the spark arrester portion of the tailpipe and inside of the tailpipe housing.

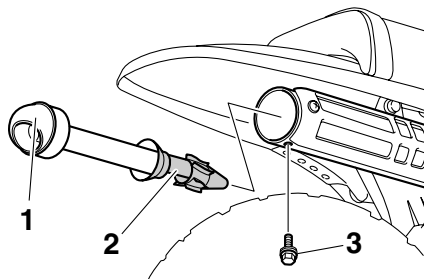

1. Tailpipe
2. Spark arrester
3. Bolt

3. Insert the tailpipe into the muffler, and then install and tighten the bolt.

**NOTE:** \_\_\_\_\_  
Make sure to align the bolt hole when inserting the tailpipe.

## Adjusting the carburetor

The carburetor is an important part of the engine and requires very sophisticated adjustment. Therefore, most carburetor adjustments should be left to a Yamaha dealer, who has the necessary professional knowledge and experience. The adjustment described in the following section, however, may be serviced by the owner as part of routine maintenance.

ECA10550

### **CAUTION:** \_\_\_\_\_

**The carburetor has been set and extensively tested at the Yamaha factory. Changing these settings without sufficient technical knowledge may result in poor performance of or damage to the engine.**

EAU21340

## Adjusting the engine idling speed

The engine idling speed must be checked and, if necessary, adjusted as follows at the intervals specified in the periodic maintenance and lubrication chart.

The engine should be warm before making this adjustment.

### NOTE:

- The engine is warm when it quickly responds to the throttle.
- A diagnostic tachometer is needed to make this adjustment.

1. Attach the tachometer to the spark plug lead.
2. Check the engine idling speed and, if necessary, adjust it to specification by turning the throttle stop screw. To increase the engine idling speed, turn the screw in direction (a). To decrease the engine idling speed, turn the screw in direction (b).

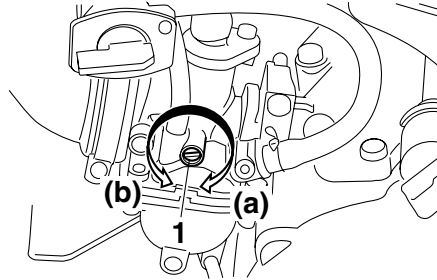

1. Throttle stop screw

**Engine idling speed:**  
1650–1750 r/min

### NOTE:

If the specified idling speed cannot be obtained as described above, have a Yamaha dealer make the adjustment.

EAU21370

## Adjusting the throttle cable free play

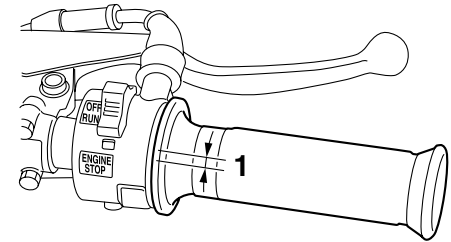

1. Throttle cable free play

The throttle cable free play should measure 3.0–5.0 mm (0.12–0.20 in) at the throttle grip. Periodically check the throttle cable free play and, if necessary, adjust it as follows.

### NOTE:

The engine idling speed must be correctly adjusted before checking and adjusting the throttle cable free play.

1. Loosen the locknut.
2. To increase the throttle cable free play, turn the adjusting nut in direction (a). To decrease the throttle

# PERIODIC MAINTENANCE AND MINOR REPAIR

cable free play, turn the adjusting nut in direction (b).

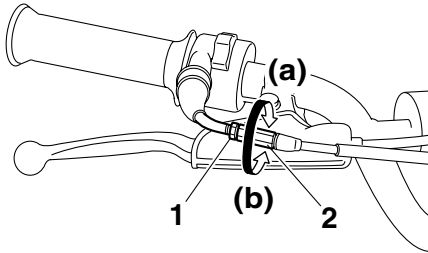

1. Locknut
2. Adjusting nut
3. Tighten the locknut.

6

## Tires

To maximize the performance, durability, and safe operation of your motorcycle, note the following points regarding the specified tires.

## Tire air pressure

The tire air pressure should be checked and, if necessary, adjusted before each ride.

### WARNING

- The tire air pressure must be checked and adjusted on cold tires (i.e., when the temperature of the tires equals the ambient temperature).
- The tire air pressure must be adjusted in accordance with the weight of the rider, the riding speed, and the riding conditions.

### Standard tire air pressure:

Front:  
100 kPa (15 psi) (1.00 kgf/cm<sup>2</sup>)  
Rear:  
100 kPa (15 psi) (1.00 kgf/cm<sup>2</sup>)

EAU39820

EWA14380

## Tire inspection

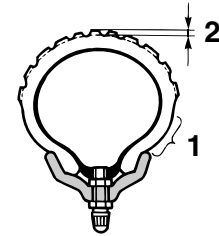

1. Tire sidewall
2. Tire tread depth

The tires must be checked before each ride. If the center tread depth reaches the specified limit, if the tire has a nail or glass fragments in it, or if the sidewall is cracked, have a Yamaha dealer replace the tire immediately.

**Minimum tire tread depth (front and rear):**  
4.0 mm (0.16 in)

## Tire information

This motorcycle is equipped with spoke wheels and tube tires.

# PERIODIC MAINTENANCE AND MINOR REPAIR

EWA10460

## WARNING

- The front and rear tires should be of the same make and design, otherwise the handling characteristics of the vehicle cannot be guaranteed.
- After extensive tests, only the tires listed below have been approved for this model by Yamaha Motor Co., Ltd.

### Front tire:

Size:

2.50-14 4PR

Manufacturer/model:

CHENG SHIN/KNOBBY

### Rear tire:

Size:

3.00-12 4PR

Manufacturer/model:

CHENG SHIN/KNOBBY

EWA14390

## WARNING

- Have a Yamaha dealer replace excessively worn tires. Operating the motorcycle with excessively worn tires decreases riding stability and can lead to

loss of control.

- The replacement of all wheel-and brake-related parts, including the tires, should be left to a Yamaha dealer, who has the necessary professional knowledge and experience.
- It is not recommended to patch a punctured tube. If unavoidable, however, patch the tube very carefully and replace it as soon as possible with a high-quality product.

EAU21940

## Spoke wheels

To maximize the performance, durability, and safe operation of your motorcycle, note the following points regarding the specified wheels.

- The wheel rims should be checked for cracks, bends or warpage, and the spokes for looseness or damage before each ride. If any damage is found, have a Yamaha dealer replace the wheel. Do not attempt even the smallest repair to the wheel. A deformed or cracked wheel must be replaced.
- The wheel should be balanced whenever either the tire or wheel has been changed or replaced. An unbalanced wheel can result in poor performance, adverse handling characteristics, and a shortened tire life.
- Ride at moderate speeds after changing a tire since the tire surface must first be “broken in” for it to develop its optimal characteristics.

# PERIODIC MAINTENANCE AND MINOR REPAIR

## Accessories and replacement parts

EAU40431

EWA14481

### WARNING

The accessories or replacement parts you choose for your vehicle should be designed specifically for this model, and they must be securely mounted to maintain the inherent stability of the original design. Genuine Yamaha Parts and Accessories are designed and tested to be compatible with your vehicle. Yamaha recommends the use of Genuine Yamaha Parts and Accessories before making a purchase. Use of non-Yamaha-approved accessories or replacement parts may cause loss of handling stability and riding safety. Since Yamaha cannot control the quality of accessories or parts manufactured by other companies, Yamaha cannot be held liable for any consequences caused by the use of items which have not been approved by Yamaha.

## Adjusting the brake lever free play

EAU22120

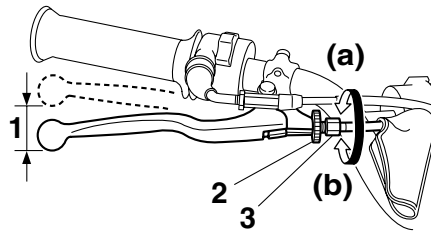

1. Brake lever free play
2. Locknut
3. Adjusting bolt

The brake lever free play should measure 10.0–20.0 mm (0.39–0.79 in) as shown. Periodically check the brake lever free play and, if necessary, adjust it as follows.

1. Loosen the locknut at the brake lever.
2. To increase the brake lever free play, turn the adjusting bolt in direction (a). To decrease the brake lever free play, turn the adjusting bolt in direction (b).

3. If the specified brake lever free play could be obtained as described above, tighten the locknut and skip the rest of the procedure, otherwise proceed as follows.
4. Fully turn the adjusting bolt at the brake lever in direction (a) to loosen the brake cable.
5. Loosen the locknut at the brake shoe plate.
6. To increase the brake lever free play, turn the adjusting nut in direction (a). To decrease the brake lever free play, turn the adjusting nut in direction (b).

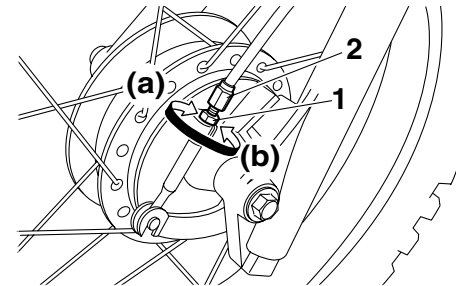

1. Locknut
2. Adjusting nut

7. Tighten the locknut at the brake



# PERIODIC MAINTENANCE AND MINOR REPAIR

shoe plate and at the brake lever.

## Adjusting the brake pedal free play

EAU39811

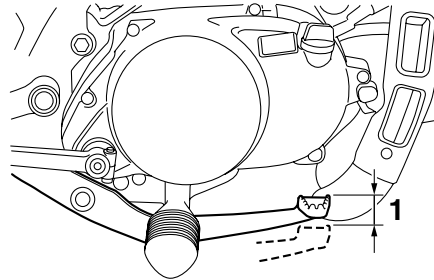

1. Brake pedal free play

The brake pedal free play should measure 10.0–20.0 mm (0.39–0.79 in) at the brake pedal end as shown. Periodically check the brake pedal free play and, if necessary, adjust it as follows.

To increase the brake pedal free play, turn the adjusting nut at the brake rod in direction (a). To decrease the brake pedal free play, turn the adjusting nut in direction (b).

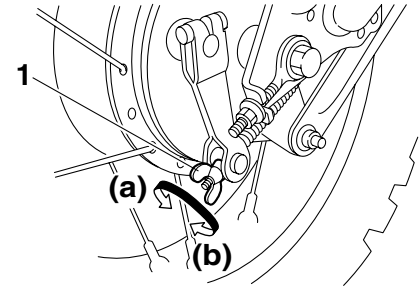

1. Brake pedal free play adjusting nut

# PERIODIC MAINTENANCE AND MINOR REPAIR

EAU41052

## Checking the front and rear brake shoes

The front and rear brake shoes must be checked for wear at the intervals specified in the periodic maintenance and lubrication chart.

### NOTE:

The wheels must be removed to check brake shoe lining thickness.

- To remove the front wheel: See page 6-23.
- To remove the rear wheel: See page 6-26.

## Front

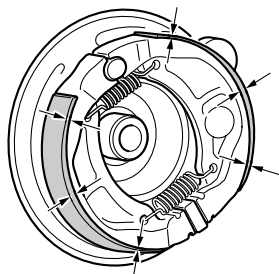

## Rear

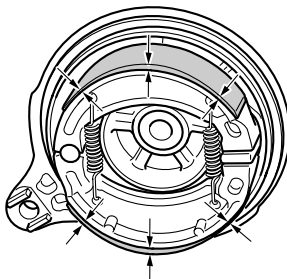

If the lining thickness of a brake shoe is less than 1.5 mm (0.06 in), have a Yamaha dealer replace the brake shoes as a set.

### NOTE:

Be sure to measure the brake lining at the thinnest portion.

EAU22760

## Drive chain slack

The drive chain slack should be checked before each ride and adjusted if necessary.

EAU22773

### To check the drive chain slack

1. Place the motorcycle on the side-stand.

### NOTE:

When checking and adjusting the drive chain slack, there should be no weight on the motorcycle.

2. Shift the transmission into the neutral position.
3. Move the rear wheel by pushing the motorcycle to locate the tightest portion of the drive chain, and then measure the drive chain slack as shown.

### Drive chain slack:

40.0–53.0 mm (1.57–2.09 in)

# PERIODIC MAINTENANCE AND MINOR REPAIR

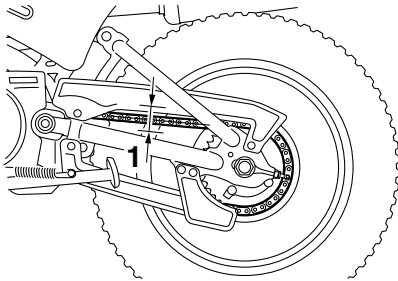

1. Drive chain slack

4. If the drive chain slack is incorrect, adjust it as follows.

## To adjust the drive chain slack

EAU40110

1. Loosen the brake pedal free play adjusting nut, axle nut, and locknut at each end of the swingarm.

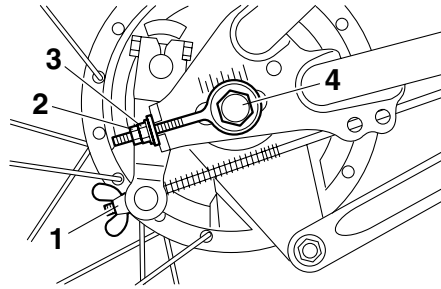

1. Brake pedal free play adjusting nut  
2. Locknut  
3. Drive chain slack adjusting nut  
4. Wheel axle

2. To tighten the drive chain, turn the adjusting nut at each end of the swingarm in direction (a). To loosen the drive chain, turn the adjusting nut at each end of the swingarm in direction (b), and then push the rear wheel forward.

## NOTE:

Using the alignment marks on each side of the swingarm, make sure that both adjusting nuts are in the same position for proper wheel alignment.

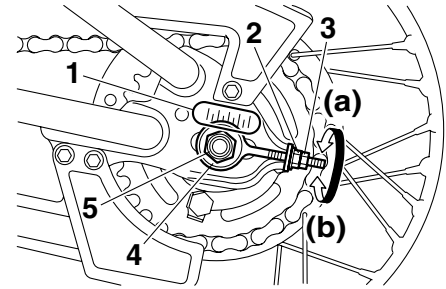

1. Alignment marks  
2. Drive chain slack adjusting nut  
3. Locknut  
4. Washer  
5. Axle nut

## CAUTION:

Improper drive chain slack will overload the engine as well as other vital parts of the motorcycle and can lead to chain slippage or breakage. To prevent this from occurring, keep the drive chain slack within the specified limits.

3. Tighten both locknuts and the axle nut to the specified torques.

ECA10570

# PERIODIC MAINTENANCE AND MINOR REPAIR

## Tightening torques:

Locknut:

6.5 Nm (0.7 m·kgf, 4.7 ft·lbf)

Axle nut:

60 Nm (6.0 m·kgf, 43.4 ft·lbf)

4. Adjust the brake pedal free play.  
(See page 6-15.)

EAU23013

## Cleaning and lubricating the drive chain

The drive chain must be cleaned and lubricated at the intervals specified in the periodic maintenance and lubrication chart, otherwise it will quickly wear out, especially when riding in dusty or wet areas. Service the drive chain as follows.

ECA10581

### CAUTION:

**The drive chain must be lubricated after washing the motorcycle and riding in the rain.**

1. Remove all dirt and mud from the drive chain with a brush or cloth.

### NOTE:

For a thorough cleaning, have a Yamaha dealer remove the drive chain and soak it in solvent.

2. Spray Yamaha Chain and Cable Lube or a high-quality spray-type drive chain lubricant on both sides and on the middle of the chain, making sure that all side plates and rollers have been sufficiently

oiled.

# PERIODIC MAINTENANCE AND MINOR REPAIR

EAU41840

## Checking and lubricating the cables

The operation of all control cables and the condition of the cables should be checked before each ride, and the cables and cable ends should be lubricated if necessary. If a cable is damaged or does not move smoothly, have a Yamaha dealer check or replace it.

### Recommended lubricant:

Yamaha Chain and Cable Lube or engine oil SAE 10W-30 (API SE)

EWA10710



### WARNING

**Damage to the outer housing of cables may result in internal rusting and cause interference with cable movement. Replace damaged cables as soon as possible to prevent unsafe conditions.**

EAU23111

## Checking and lubricating the throttle grip and cable

The operation of the throttle grip should be checked before each ride. In addition, the cable should be lubricated at the intervals specified in the periodic maintenance chart.

EAU23120

## Adjusting the Autolube pump

The Autolube pump is a vital and sophisticated component of the engine, which must be adjusted by a Yamaha dealer at the intervals specified in the periodic maintenance and lubrication chart.

# PERIODIC MAINTENANCE AND MINOR REPAIR

EAU44270

## Checking and lubricating the brake and shift pedals

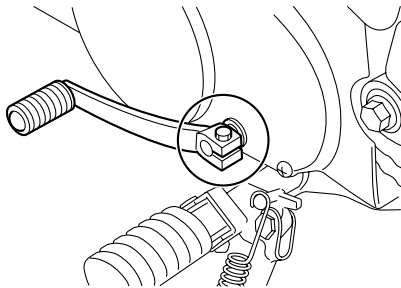
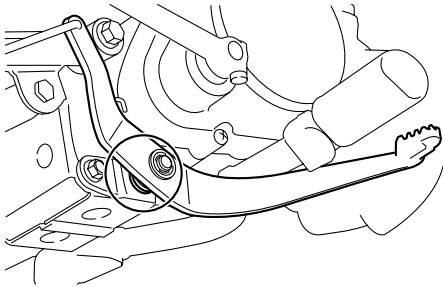

The operation of the brake and shift pedals should be checked before each ride, and the pedal pivots should be lubricated if necessary.

**Recommended lubricant:**  
Lithium-soap-based grease (all-purpose grease)

EAU43620

## Checking and lubricating the brake lever

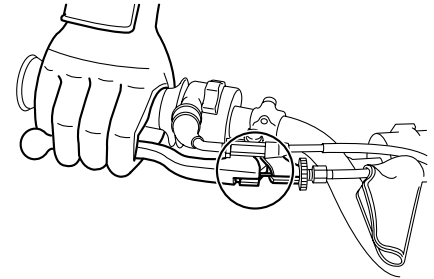

1. Grease nipple

The operation of the brake lever should be checked before each ride, and the lever pivots should be lubricated if necessary.

**Recommended lubricant:**  
Lithium-soap-based grease (all-purpose grease)

## Checking and lubricating the sidestand

EAU23200

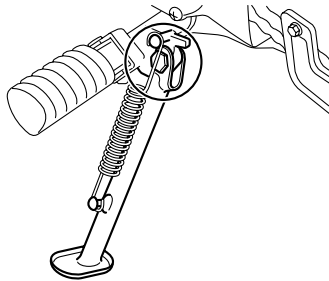

The operation of the sidestand should be checked before each ride, and the sidestand pivot and metal-to-metal contact surfaces should be lubricated if necessary.

EWA10730

### **WARNING**

**If the sidestand does not move up and down smoothly, have a Yamaha dealer check or repair it.**

#### **Recommended lubricant:**

Lithium-soap-based grease (all-purpose grease)

## Checking the front fork

EAU23271

The condition and operation of the front fork must be checked as follows at the intervals specified in the periodic maintenance and lubrication chart.

### To check the condition

EWA10750

#### **WARNING**

**Securely support the vehicle so that there is no danger of it falling over.**

Check the inner tubes for scratches, damage and excessive oil leakage.

### To check the operation

1. Place the vehicle on a level surface and hold it in an upright position.
2. While applying the front brake, push down hard on the handlebars several times to check if the front fork compresses and rebounds smoothly.

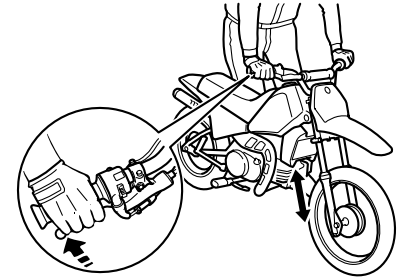

ECA10590

#### **CAUTION:**

**If any damage is found or the front fork does not operate smoothly, have a Yamaha dealer check or repair it.**

# PERIODIC MAINTENANCE AND MINOR REPAIR

EAU23280

## Checking the steering

Worn or loose steering bearings may cause danger. Therefore, the operation of the steering must be checked as follows at the intervals specified in the periodic maintenance and lubrication chart.

1. Place a stand under the engine to raise the front wheel off the ground.

EWA10750

### **WARNING**

**Securely support the vehicle so that there is no danger of it falling over.**

2. Hold the lower ends of the front fork legs and try to move them forward and backward. If any free play can be felt, have a Yamaha dealer check or repair the steering.

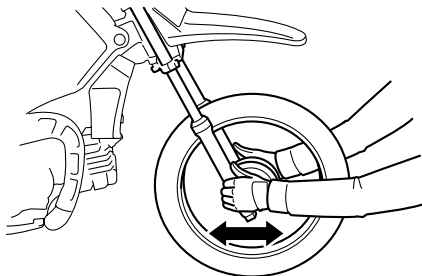

EAU23290

## Checking the wheel bearings

The front and rear wheel bearings must be checked at the intervals specified in the periodic maintenance and lubrication chart. If there is play in the wheel hub or if the wheel does not turn smoothly, have a Yamaha dealer check the wheel bearings.



# PERIODIC MAINTENANCE AND MINOR REPAIR

EAU24350

## Supporting the motorcycle

Since this model is not equipped with a centerstand, follow these precautions when removing the front and rear wheel or performing other maintenance requiring the motorcycle to stand upright. Check that the motorcycle is in a stable and level position before starting any maintenance. A strong wooden box can be placed under the engine for added stability.

## To service the front wheel

1. Stabilize the rear of the motorcycle by using a motorcycle stand or, if an additional motorcycle stand is not available, by placing a jack under the frame in front of the rear wheel.
2. Raise the front wheel off the ground by using a motorcycle stand.

## To service the rear wheel

Raise the rear wheel off the ground by using a motorcycle stand or, if a motorcycle stand is not available, by placing a jack either under each side of the

frame in front of the rear wheel or under each side of the swingarm.

EAU24360

## Front wheel

EAU41530

## To remove the front wheel

EWA10820

### **WARNING**

- It is advisable to have a Yamaha dealer service the wheel.
- Securely support the motorcycle so that there is no danger of it falling over.

1. Remove the brake cable holder by removing the bolt.

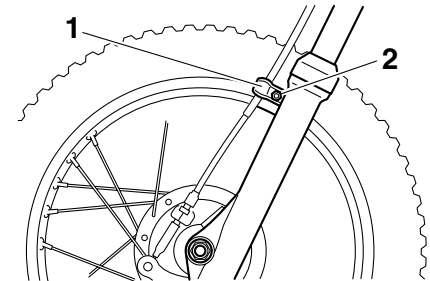

1. Brake cable holder
2. Bolt

2. Loosen the brake cable locknut and the brake cable free play ad-

# PERIODIC MAINTENANCE AND MINOR REPAIR

justing nut at the front wheel hub.

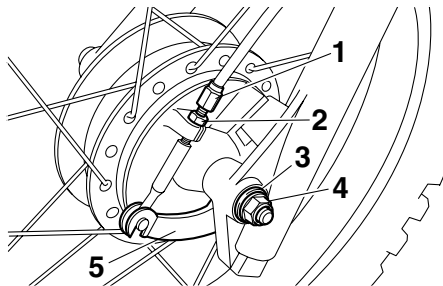

1. Adjusting nut
2. Locknut
3. Washer
4. Axle nut
5. Brake camshaft lever

3. Loosen the locknut at the brake lever, and then turn the adjusting bolt fully in direction (a).

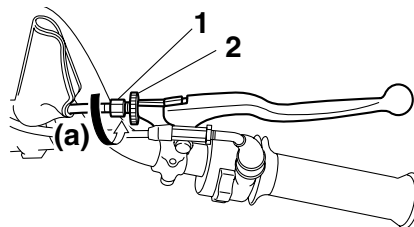

1. Adjusting bolt
2. Locknut

4. Disconnect the brake cable from the front brake lever.
5. Disconnect the brake cable from the brake camshaft lever.
6. Remove the axle nut and washer.

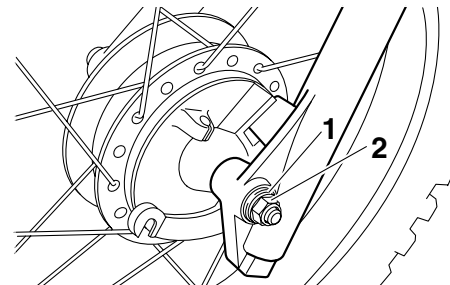

1. Washer
2. Axle nut

7. Lift the front wheel off the ground according to the procedure on page 6-23.
8. Pull the wheel axle out, and then remove the wheel.

## To install the front wheel

1. Install the brake shoe plate into the wheel hub as shown.

EAU41550

# PERIODIC MAINTENANCE AND MINOR REPAIR

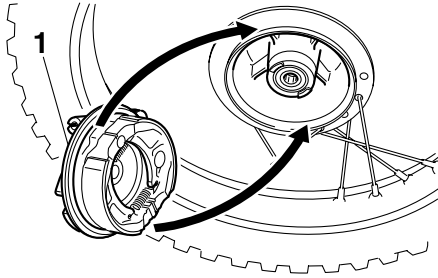

1. Brake shoe plate

2. Lift the wheel up between the fork legs.

**NOTE:** \_\_\_\_\_  
Make sure that the slot in the brake shoe plate fits over the retainer on the fork leg.  
\_\_\_\_\_

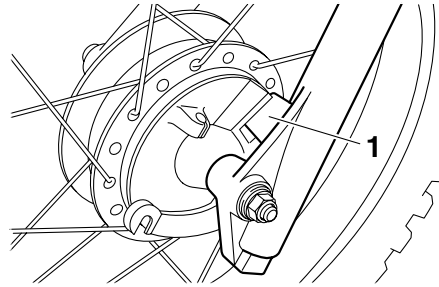

1. Retainer

3. Insert the wheel axle, and then install the washer and axle nut.
4. Lower the front wheel so that it is on the ground.
5. Connect the brake cable at the wheel hub.
6. Connect the brake cable at the front brake lever.
7. Install the brake cable holder by installing the bolt.
8. Tighten the axle nut to the specified torque.

**Tightening torque:**

Axle nut:

35 Nm (3.5 m·kgf, 25.3 ft·lbf)

9. Adjust the brake lever free play.

(See page 6-14.)

10. Push down hard on the handlebar several times to check for proper fork operation.

# PERIODIC MAINTENANCE AND MINOR REPAIR

## Rear wheel

EAU25080

### To remove the rear wheel

EAU41560

EWA10820

#### **WARNING**

- It is advisable to have a Yamaha dealer service the wheel.
- Securely support the motorcycle so that there is no danger of it falling over.

1. Loosen the axle nut.

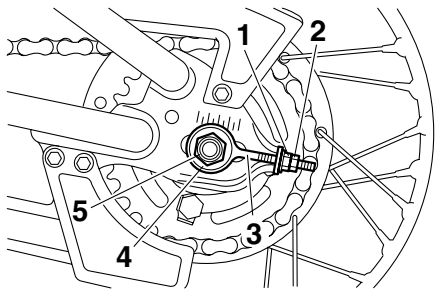

1. Drive chain slack adjusting nut
2. Locknut
3. Chain puller
4. Washer
5. Axle nut

2. Remove the brake pedal free play

adjusting nut, and then disconnect the brake rod from the brake camshaft lever.

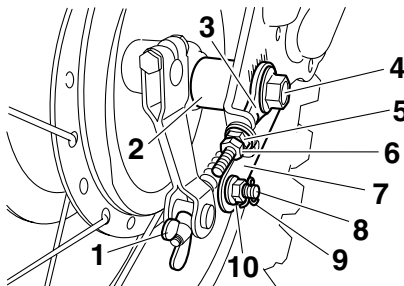

1. Brake pedal free play adjusting nut
2. Spacer
3. Chain puller
4. Wheel axle
5. Drive chain slack adjusting nut
6. Locknut
7. Brake torque rod
8. Brake torque rod bolt
9. Cotter pin
10. Brake torque rod nut

3. Disconnect the brake torque rod from the brake shoe plate by removing the cotter pin, the nut, and the bolt.

4. Loosen the locknut and drive chain adjusting nut on each end of the

swingarm.

5. Lift the rear wheel off the ground according to the procedure on page 6-23.

6. Remove the axle nut and washer, and then pull the wheel axle out.

7. Push the wheel forward, and then remove the drive chain from the rear sprocket.

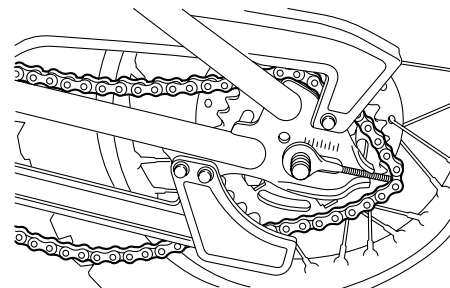

#### **NOTE:**

The drive chain does not need to be disassembled in order to remove and install the wheel.

8. Remove the spacer, chain pullers and wheel by pulling it back.

# PERIODIC MAINTENANCE AND MINOR REPAIR

EAU41570

## To install the rear wheel

1. Install the drive chain onto the rear sprocket.
2. Install the wheel by inserting the chain pullers, spacer and then insert the wheel axle from the right-hand side.
3. Install the brake rod onto the brake camshaft lever, and then install the brake pedal free play adjusting nut onto the brake rod.
4. Connect the brake torque rod onto the brake shoe plate by installing the bolt and nut, and then tighten the nut to the specified torque.

### Tightening torque:

Brake torque rod nut:  
15.5 Nm (1.6 m·kgf, 11.2 ft·lbf)

5. Insert a new cotter pin into the brake torque rod bolt.

EWA10830



## WARNING

**Always use a new cotter pin.**

6. Install the washer and axle nut, and then lower the rear wheel so that it is on the ground.

7. Adjust the drive chain slack. (See page 6-16.)
8. Tighten the axle nut to the specified torque.

### Tightening torque:

Axle nut:  
60 Nm (6.0 m·kgf, 43.4 ft·lbf)

9. Adjust the brake pedal free play. (See page 6-15.)

EAU25850

## Troubleshooting

Although Yamaha motorcycles receive a thorough inspection before shipment from the factory, trouble may occur during operation. Any problem in the fuel, compression, or ignition systems, for example, can cause poor starting and loss of power.

The following troubleshooting chart represents a quick and easy procedure for checking these vital systems yourself. However, should your motorcycle require any repair, take it to a Yamaha dealer, whose skilled technicians have the necessary tools, experience, and know-how to service the motorcycle properly.

Use only genuine Yamaha replacement parts. Imitation parts may look like Yamaha parts, but they are often inferior, have a shorter service life and can lead to expensive repair bills.

# PERIODIC MAINTENANCE AND MINOR REPAIR

EAU25971

## Troubleshooting chart

EWA10840



**WARNING**

Keep away open flames and do not smoke while checking or working on the fuel system.

### 1. Fuel

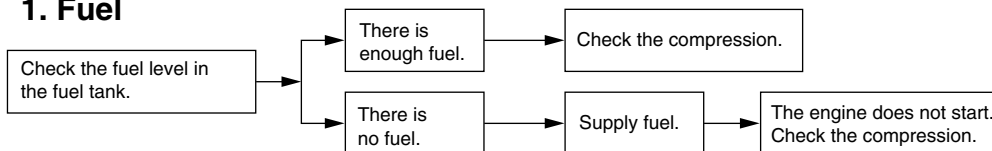

### 2. Compression

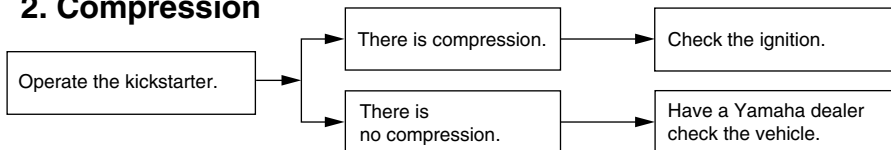

### 3. Ignition

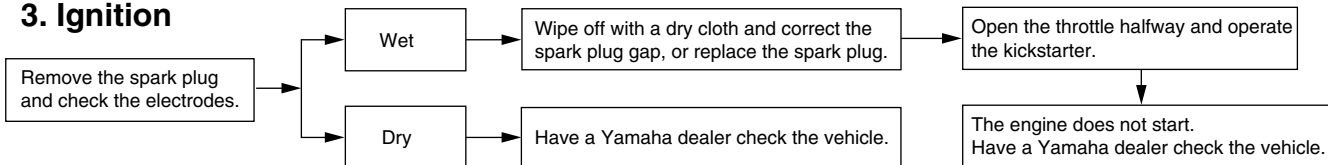

## Matte color caution

EAU37833

ECA15192

### **CAUTION:**

Some models are equipped with matte colored finished parts. Be sure to consult a Yamaha dealer for advice on what products to use before cleaning the vehicle. Using a brush, harsh chemical products or cleaning compounds when cleaning these parts will scratch or damage their surface. Wax also should not be applied to any matte colored finished parts.

## Care

EAU40462

While the open design of a motorcycle reveals the attractiveness of the technology, it also makes it more vulnerable. Rust and corrosion can develop even if high-quality components are used. A rusty exhaust pipe may go unnoticed on a car, however, it detracts from the overall appearance of a motorcycle. Frequent and proper care does not only comply with the terms of the warranty, but it will also keep your motorcycle looking good, extend its life and optimize its performance.

## Before cleaning

1. Cover the muffler outlet with a plastic bag after the engine has cooled down.
2. Make sure that all caps and covers as well as all electrical couplers and connectors, including the spark plug cap, are tightly installed.
3. Remove extremely stubborn dirt, like oil burnt onto the crankcase, with a degreasing agent and a brush, but never apply such prod-

ucts onto seals, gaskets, sprockets, the drive chain and wheel axles. Always rinse the dirt and degreaser off with water.

## Cleaning

ECA10771

### **CAUTION:**

- Avoid using strong acidic wheel cleaners, especially on spoked wheels. If such products are used on hard-to-remove dirt, do not leave the cleaner on the affected area any longer than instructed. Also, thoroughly rinse the area off with water, immediately dry it, and then apply a corrosion protection spray.
- Improper cleaning can damage plastic parts such as cowlings, panels, windshields, headlight lenses, meter lenses, etc. Use only a soft, clean cloth or sponge with mild detergent and water to clean plastic.
- Do not use any harsh chemical products on plastic parts. Be sure to avoid using cloths or sponges which have been in

# MOTORCYCLE CARE AND STORAGE

---

contact with strong or abrasive cleaning products, solvent or thinner, fuel (gasoline), rust removers or inhibitors, brake fluid, antifreeze or electrolyte.

- Do not use high-pressure washers or steam-jet cleaners since they cause water seepage and deterioration in the following areas: seals (of wheel and swing-arm bearings, fork and brakes), electric components (couplers, connectors, instruments, switches and lights), breather hoses and vents.
- For motorcycles equipped with a windshield: Do not use strong cleaners or hard sponges as they will cause dulling or scratching. Some cleaning compounds for plastic may leave scratches on the windshield. Test the product on a small hidden part of the windshield to make sure that it does not leave any marks. If the windshield is scratched, use a quality plastic polishing compound after

## washing.

---

### After normal use

Remove dirt with warm water, a mild detergent, and a soft, clean sponge, and then rinse thoroughly with clean water. Use a toothbrush or bottlebrush for hard-to-reach areas. Stubborn dirt and insects will come off more easily if the area is covered with a wet cloth for a few minutes before cleaning.

### After riding in the rain or near the sea

Since sea salt is extremely corrosive, carry out the following steps after each ride in the rain or near the sea.

1. Clean the motorcycle with cold water and a mild detergent, after the engine has cooled down.

ECA10790

### **CAUTION:**

---

**Do not use warm water since it increases the corrosive action of the salt.**

---

2. Apply a corrosion protection spray on all metal, including chrome- and nickel-plated, surfaces to prevent corrosion.

## After cleaning

1. Dry the motorcycle with a chamois or an absorbing cloth.
2. Immediately dry the drive chain and lubricate it to prevent it from rusting.
3. Use a chrome polish to shine chrome, aluminum and stainless-steel parts, including the exhaust system. (Even the thermally induced discoloring of stainless-steel exhaust systems can be removed through polishing.)
4. To prevent corrosion, it is recommended to apply a corrosion protection spray on all metal, including chrome- and nickel-plated, surfaces.
5. Use spray oil as a universal cleaner to remove any remaining dirt.
6. Touch up minor paint damage caused by stones, etc.
7. Wax all painted surfaces.
8. Let the motorcycle dry completely before storing or covering it.

EWA14500

### **WARNING**

---

- Make sure that there is no oil or



# MOTORCYCLE CARE AND STORAGE

wax on the tires.

- If necessary, wash the tires with warm water and a mild detergent. Before riding at higher speeds, test the motorcycle's braking performance and cornering behavior.

ECA10800

## CAUTION:

- Apply spray oil and wax sparingly and make sure to wipe off any excess.
- Never apply oil or wax to any rubber and plastic parts, but treat them with a suitable care product.
- Avoid using abrasive polishing compounds as they will wear away the paint.

## NOTE:

Consult a Yamaha dealer for advice on what products to use.

EAU40651

## Storage

### Short-term

Always store your motorcycle in a cool, dry place and, if necessary, protect it against dust with a porous cover.

ECA10810

## CAUTION:

- Storing the motorcycle in a poorly ventilated room or covering it with a tarp, while it is still wet, will allow water and humidity to seep in and cause rust.
- To prevent corrosion, avoid damp cellars, stables (because of the presence of ammonia) and areas where strong chemicals are stored.

### Long-term

Before storing your motorcycle for several months:

1. Follow all the instructions in the "Care" section of this chapter.
2. For motorcycles equipped with a fuel cock that has an "OFF" position: Turn the fuel cock lever to

"OFF".

3. Drain the carburetor float chamber by loosening the drain bolt; this will prevent fuel deposits from building up. Pour the drained fuel into the fuel tank.
4. Fill up the fuel tank and add fuel stabilizer (if available) to prevent the fuel tank from rusting and the fuel from deteriorating.
5. Perform the following steps to protect the cylinder, piston rings, etc. from corrosion.
  - a. Remove the spark plug cap and spark plug.
  - b. Pour a teaspoonful of engine oil into the spark plug bore.
  - c. Install the spark plug cap onto the spark plug, and then place the spark plug on the cylinder head so that the electrodes are grounded. (This will limit sparking during the next step.)
  - d. Turn the engine over several times with the starter. (This will coat the cylinder wall with oil.)
  - e. Remove the spark plug cap from the spark plug, and then

# MOTORCYCLE CARE AND STORAGE

---

install the spark plug and the spark plug cap.

EWA10950

## **WARNING**

**To prevent damage or injury from sparking, make sure to ground the spark plug electrodes while turning the engine over.**

---

6. Lubricate all control cables and the pivoting points of all levers and pedals as well as of the sidestand.
7. Check and, if necessary, correct the tire air pressure, and then lift the motorcycle so that both of its wheels are off the ground. Alternatively, turn the wheels a little every month in order to prevent the tires from becoming degraded in one spot.
8. Cover the muffler outlet with a plastic bag to prevent moisture from entering it.

### **NOTE:** \_\_\_\_\_

Make any necessary repairs before storing the motorcycle.

---

EAU2633K

## Dimensions:

- Overall length:  
1540 mm (60.6 in)
- Overall width:  
640 mm (25.2 in)
- Overall height:  
880 mm (34.6 in)
- Seat height:  
635 mm (25.0 in)
- Wheelbase:  
1055 mm (41.5 in)
- Ground clearance:  
185 mm (7.28 in)
- Minimum turning radius:  
1700 mm (66.9 in)

## Weight:

- With oil and fuel:  
61.0 kg (134 lb)

## Engine:

- Engine type:  
Air cooled 2-stroke
- Cylinder arrangement:  
Forward-inclined single cylinder
- Displacement:  
79.0 cm<sup>3</sup>
- Bore × stroke:  
47.0 × 45.6 mm (1.85 × 1.80 in)
- Compression ratio:  
6.60 :1
- Starting system:  
Kickstarter

## Lubrication system:

- Separate lubrication (Yamaha autolube)

## Engine oil:

- Type:  
YAMALUBE 2 or 2-stroke engine oil (JASO FC grade) or (ISO EG-C or EG-D grade)

## Engine oil quantity:

- Quantity:  
0.95 L (1.00 US qt) (0.84 Imp.qt)

## Transmission oil:

- Type:  
YAMALUBE 4 (10W30) or SAE 10W30
- Oil change quantity:  
0.65 L (0.69 US qt) (0.57 Imp.qt)

## Air filter:

- Air filter element:  
Wet element

## Fuel:

- Recommended fuel:  
Regular unleaded gasoline only  
(AUT)(BEL)(CHE)(DEU)(DNK)(ESP)(FIN)  
(FRA)(GBR)(GRC)(IRL)(NLD)(NOR)(PRT)  
(SWE)(ZAF)  
Unleaded gasoline only (AUS)(NZL)
- Fuel tank capacity:  
4.9 L (1.29 US gal) (1.08 Imp.gal)
- Fuel reserve amount:  
1.0 L (0.26 US gal) (0.22 Imp.gal)

## Carburetor:

- Manufacturer:  
MIKUNI
- Type × quantity:  
VM15SC × 1

## Spark plug (s):

- Manufacturer/model:  
NGK/BP6HS (AUS)(NZL)  
NGK/BPR6HS  
(AUT)(BEL)(CHE)(DEU)(DNK)(ESP)(FIN)  
(FRA)(GBR)(GRC)(IRL)(NLD)(NOR)(PRT)  
(SWE)(ZAF)
- Manufacturer/model:  
DENSO/W20FP (AUS)(NZL)
- Spark plug gap:  
0.6–0.7 mm (0.024–0.028 in)

## Clutch:

- Clutch type:  
Wet, multiple-disc automatic

## Transmission:

- Primary reduction system:  
Helical gear
- Primary reduction ratio:  
66/21 (3.143)
- Secondary reduction system:  
Chain drive
- Secondary reduction ratio:  
32/15 (2.133)
- Transmission type:  
Constant mesh 3-speed
- Operation:  
Left foot operation

## Gear ratio:

- 1st:  
39/12 (3.250)
- 2nd:  
29/16 (1.812)

# SPECIFICATIONS

---

3rd:  
22/17 (1.294)

## Chassis:

Frame type:  
Steel tube backbone  
Caster angle:  
26.00 °  
Trail:  
62.0 mm (2.44 in)

## Front tire:

Type:  
With tube  
Size:  
2.50-14 4PR  
Manufacturer/model:  
CHENG SHIN/KNOBBY

## Rear tire:

Type:  
With tube  
Size:  
3.00-12 4PR  
Manufacturer/model:  
CHENG SHIN/KNOBBY

## Loading:

Maximum rider weight:  
40.0 kg (88 lb)  
Maximum load:  
40 kg (88 lb)  
\* (Total weight of rider, cargo and accessories)

## Tire air pressure (measured on cold tires):

Front:  
100 kPa (15 psi) (1.00 kgf/cm<sup>2</sup>)  
Rear:  
100 kPa (15 psi) (1.00 kgf/cm<sup>2</sup>)

## Front wheel:

Wheel type:  
Spoke wheel  
Rim size:  
14x1.40

## Rear wheel:

Wheel type:  
Spoke wheel  
Rim size:  
12x1.60

## Front brake:

Type:  
Drum brake  
Operation:  
Right hand operation

## Rear brake:

Type:  
Drum brake  
Operation:  
Right foot operation

## Front suspension:

Type:  
Telescopic fork  
Spring/shock absorber type:  
Coil spring/oil damper  
Wheel travel:  
110.0 mm (4.33 in)

## Rear suspension:

Type:  
Swingarm (monocross)  
Spring/shock absorber type:  
Coil spring/gas-oil damper  
Wheel travel:  
95.0 mm (3.74 in)

## Electrical system:

Ignition system:  
CDI

EAU40790

EAU26400

EAU26480

## Identification numbers

Record the vehicle identification number and model label information in the spaces provided below for assistance when ordering spare parts from a Yamaha dealer or for reference in case the vehicle is stolen.

VEHICLE IDENTIFICATION NUMBER:

MODEL LABEL INFORMATION:

## Vehicle identification number

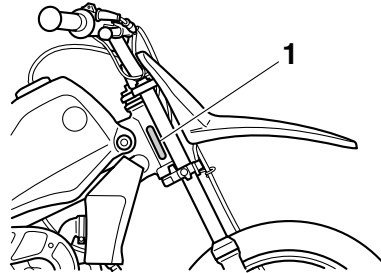

1. Vehicle identification number

The vehicle identification number is stamped into the steering head pipe. Record this number in the space provided.

**NOTE:** \_\_\_\_\_

The vehicle identification number is used to identify your motorcycle and may be used to register your motorcycle with the licensing authority in your area.

\_\_\_\_\_

## Model label

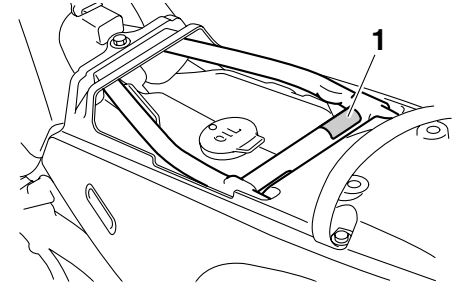

1. Model label

The model label is affixed to the frame under the seat. (See page 3-6.) Record the information on this label in the space provided. This information will be needed when ordering spare parts from a Yamaha dealer.

# INDEX

---

## A

- Accessories and replacement parts ..... 6-14
- Air filter element, cleaning ..... 6-8
- Autolube pump, adjusting ..... 6-19

## B

- Brake and shift pedals, checking and lubricating ..... 6-20
- Brake lever ..... 3-2
- Brake lever, checking and lubricating ..... 6-20
- Brake lever free play, adjusting ..... 6-14
- Brake pedal ..... 3-2
- Brake pedal free play, adjusting ..... 6-15
- Brake shoes, checking ..... 6-16

## C

- Cables, checking and lubricating ..... 6-19
- Carburetor, adjusting ..... 6-10
- Care ..... 7-1

## D

- Drive chain, cleaning and lubricating ..... 6-18
- Drive chain slack ..... 6-16

## E

- Engine break-in ..... 5-3
- Engine idling speed ..... 6-11
- Engine oil ..... 3-4
- Engine, starting a warm ..... 5-2
- Engine stop switch ..... 3-1

## F

- Front fork, checking ..... 6-21
- Fuel ..... 3-3
- Fuel cock ..... 3-5
- Fuel tank breather hose ..... 3-4
- Fuel tank cap ..... 3-2

## H

- Handlebar switch ..... 3-1

## I

- Identification numbers ..... 9-1

## K

- Kickstarter ..... 3-6

## L

- Labels, location of ..... 1-4

## M

- Matte color, caution ..... 7-1
- Model label ..... 9-1

## P

- Parking ..... 5-4
- Part locations ..... 2-1
- Periodic maintenance and lubrication chart ..... 6-2
- Power reduction plate ..... 3-1
- Power reduction plate, removing ..... 6-6
- Pre-operation check list ..... 4-2

## S

- Safety information ..... 1-1
- Seat ..... 3-6
- Shifting ..... 5-2
- Shift pedal ..... 3-1
- Shock absorber ..... 3-7
- Sidestand, checking and lubricating ..... 6-21
- Spark arrester, cleaning ..... 6-9
- Spark plug, checking ..... 6-5
- Specifications ..... 8-1
- Starter (choke) lever ..... 3-6
- Starting and warming up a cold engine ..... 5-1
- Steering, checking ..... 6-22
- Storage ..... 7-3
- Supporting the motorcycle ..... 6-23

## T

- Throttle cable free play, adjusting ..... 6-11

## Throttle grip and cable, checking and

- lubricating ..... 6-19
- Tires ..... 6-12
- Tool kit ..... 6-1
- Transmission oil ..... 6-7
- Troubleshooting ..... 6-27
- Troubleshooting chart ..... 6-28

## V

- Vehicle identification number ..... 9-1

## W

- Wheel bearings, checking ..... 6-22
- Wheel (front) ..... 6-23
- Wheel (rear) ..... 6-26
- Wheels ..... 6-13





YAMAHA MOTOR CO., LTD.

PRINTED ON RECYCLED PAPER

PRINTED IN JAPAN  
2007.4-0.7x1   
(E)