



 Read this manual carefully before operating this vehicle.

OWNER'S MANUAL



WR450F

1DX-28199-E2

 **Read this manual carefully before operating this vehicle. This manual should stay with this vehicle if it is sold.**

Welcome to the Yamaha world of motorcycling!

As the owner of the WR450F, you are benefiting from Yamaha's vast experience and newest technology regarding the design and manufacture of high-quality products, which have earned Yamaha a reputation for dependability.

Please take the time to read this manual thoroughly, so as to enjoy all advantages of your WR450F. The Owner's Manual does not only instruct you in how to operate, inspect and maintain your motorcycle, but also in how to safeguard yourself and others from trouble and injury.

In addition, the many tips given in this manual will help keep your motorcycle in the best possible condition. If you have any further questions, do not hesitate to contact your Yamaha dealer.

The Yamaha team wishes you many safe and pleasant rides. So, remember to put safety first!

Yamaha continually seeks advancements in product design and quality. Therefore, while this manual contains the most current product information available at the time of printing, there may be minor discrepancies between your motorcycle and this manual. If there is any question concerning this manual, please consult a Yamaha dealer.





Please read this manual carefully and completely before operating this motorcycle.

IMPORTANT MANUAL INFORMATION

EAU10133

Particularly important information is distinguished in this manual by the following notations:

	This is the safety alert symbol. It is used to alert you to potential personal injury hazards. Obey all safety messages that follow this symbol to avoid possible injury or death.
	A WARNING indicates a hazardous situation which, if not avoided, could result in death or serious injury.
	A NOTICE indicates special precautions that must be taken to avoid damage to the vehicle or other property.
TIP	A TIP provides key information to make procedures easier or clearer.

*Product and specifications are subject to change without notice.

IMPORTANT MANUAL INFORMATION

EAU10200

**WR450F
OWNER'S MANUAL
©2013 by Yamaha Motor Co., Ltd.
1st edition, February 2013
All rights reserved.
Any reprinting or unauthorized use
without the written permission of
Yamaha Motor Co., Ltd.
is expressly prohibited.
Printed in Japan.**

TABLE OF CONTENTS

SAFETY INFORMATION	1-1	Ignition circuit cut-off system	3-19	Checking the throttle grip free play	6-17
DESCRIPTION	2-1	FOR YOUR SAFETY –		Valve clearance	6-18
Left view	2-1	PRE-OPERATION CHECKS	4-1	Tires	6-18
Right view	2-2	OPERATION AND IMPORTANT		Spoke wheels	6-20
Controls and instruments.....	2-3	RIDING POINTS	5-1	Adjusting the clutch lever free play	6-20
INSTRUMENT AND CONTROL		Starting a cold engine	5-1	Checking the brake lever free play	6-21
FUNCTIONS	3-1	Starting a warm engine	5-3	Checking the shift pedal	6-22
Main switch	3-1	Shifting	5-3	Brake light switches	6-22
Indicator lights and warning lights	3-1	Tips for reducing fuel consumption	5-4	Checking the front and rear brake pads	6-23
Multi-function display	3-2	Engine break-in	5-4	Checking the brake fluid level	6-23
Handlebar switches	3-7	Parking	5-5	Changing the brake fluid	6-24
Clutch lever	3-8	PERIODIC MAINTENANCE AND		Drive chain slack	6-25
Shift pedal	3-8	ADJUSTMENT	6-1	Cleaning and lubricating the drive chain	6-26
Brake lever	3-8	Owner's tool kit	6-2	Checking and lubricating the cables	6-27
Brake pedal	3-9	Periodic maintenance chart for the emission control system	6-3	Checking and lubricating the throttle grip and cable	6-27
Fuel tank cap	3-9	General maintenance and lubrication chart	6-4	Checking and lubricating the brake and clutch levers	6-27
Fuel	3-10	Removing and installing the panel	6-7	Checking and lubricating the brake pedal	6-28
Fuel tank breather hose	3-11	Checking the spark plug	6-7	Checking and lubricating the sidestand	6-28
Catalytic converter	3-11	Engine oil and oil filter element	6-8	Lubricating the swingarm pivots	6-29
Starter knob	3-12	Coolant	6-12	Checking the front fork	6-29
Kickstarter	3-12	Cleaning the air filter element and check hose	6-14		
Steering lock	3-13	Adjusting the engine idling speed	6-17		
Seat	3-13				
Adjusting the front fork	3-14				
Front fork bleeding	3-15				
Adjusting the shock absorber assembly	3-16				
Sidestand	3-18				

TABLE OF CONTENTS

Checking the steering	6-30
Checking the wheel bearings	6-30
Battery	6-30
Replacing the fuse	6-32
Replacing the headlight bulb	6-32
Tail/brake light	6-34
Replacing a turn signal light bulb	6-34
Replacing the license plate light bulb	6-35
Replacing an auxiliary light bulb	6-35
Supporting the motorcycle	6-36
Front wheel	6-37
Rear wheel	6-38
Troubleshooting	6-40
Troubleshooting charts	6-41

MOTORCYCLE CARE AND

STORAGE	7-1
Matte color caution	7-1
Care	7-1
Storage	7-3

SPECIFICATIONS	8-1
-----------------------------	-----

CONSUMER INFORMATION	9-1
Identification numbers	9-1

SAFETY INFORMATION

EAU53004

1

Be a Responsible Owner

As the vehicle's owner, you are responsible for the safe and proper operation of your motorcycle.

Motorcycles are single-track vehicles. Their safe use and operation are dependent upon the use of proper riding techniques as well as the expertise of the operator. Every operator should know the following requirements before riding this motorcycle.

He or she should:

- Obtain thorough instructions from a competent source on all aspects of motorcycle operation.
- Observe the warnings and maintenance requirements in this Owner's Manual.
- Obtain qualified training in safe and proper riding techniques.
- Obtain professional technical service as indicated in this Owner's Manual and/or when made necessary by mechanical conditions.
- Never operate a motorcycle without proper training or instruction.

Take a training course. Beginners should receive training from a certified instructor. Contact an authorized motorcycle dealer to find out about the training courses nearest you.

Safe Riding

Perform the pre-operation checks each time you use the vehicle to make sure it is in safe operating condition. Failure to inspect or maintain the vehicle properly increases the possibility of an accident or equipment damage. See page 4-1 for a list of pre-operation checks.

- This motorcycle is designed to carry the operator only.
- No passengers.
- This motorcycle is intended to use as a competition model including enduro usage.
- This motorcycle is not designed nor intended for continuous "Paved Road" use. Never use this motorcycle on highway (motorway)/expressway.
- If any of the components that are necessary for the vehicle to comply with regulations are modified or

replaced with non-specified components, the vehicle will no longer meet the regulations.

- Watch carefully for other vehicles when operating on unpaved public streets or roads. Make sure you know your country's laws and regulations before you ride on unpaved public streets or roads.
- The failure of motorists to detect and recognize motorcycles in traffic is the predominating cause of automobile/motorcycle accidents. Many accidents have been caused by an automobile driver who did not see the motorcycle. Making yourself conspicuous appears to be very effective in reducing the chance of this type of accident.

Therefore:

- Wear a brightly colored jacket.
- Use extra caution when you are approaching and passing through intersections, since intersections are the most likely places for motorcycle accidents to occur.
- Ride where other motorists can see you. Avoid riding in another



motorist's blind spot.

- Never maintain a motorcycle without proper knowledge. Contact an authorized motorcycle dealer to inform you on basic motorcycle maintenance. Certain maintenance can only be carried out by certified staff.
- Many accidents involve inexperienced operators.
 - Make sure that you are qualified and that you only lend your motorcycle to other qualified operators.
 - Know your skills and limits. Staying within your limits may help you to avoid an accident.
 - We recommend that you practice riding your motorcycle until you have become thoroughly familiar with the motorcycle and all of its controls.
- Many accidents have been caused by error of the motorcycle operator. A typical error made by the operator is veering wide on a turn due to excessive speed or undercornering (insufficient lean angle for the speed).

- Always obey the speed limit and never travel faster than warranted by road and traffic conditions.
- Always signal before turning or changing lanes. Make sure that other motorists can see you.
- Ride cautiously in unfamiliar areas. You may encounter hidden obstacles that could cause an accident.
- The posture of the operator is important for proper control. The operator should keep both hands on the handlebar and both feet on the operator footrests during operation to maintain control of the motorcycle.
- Never ride under the influence of alcohol or other drugs.

Protective Apparel

The majority of fatalities from motorcycle accidents are the result of head injuries. The use of a safety helmet is the single most critical factor in the prevention or reduction of head injuries.

- Always wear an approved helmet.
- Wear a face shield or goggles. Wind in your unprotected eyes

could contribute to an impairment of vision that could delay seeing a hazard.

- The use of a jacket, heavy boots, trousers, gloves, etc., is effective in preventing or reducing abrasions or lacerations.
- Never wear loose-fitting clothes, otherwise they could catch on the control levers, footrests, or wheels and cause injury or an accident.
- Always wear protective clothing that covers your legs, ankles, and feet. The engine or exhaust system become very hot during or after operation and can cause burns.

Avoid Carbon Monoxide Poisoning

All engine exhaust contains carbon monoxide, a deadly gas. Breathing carbon monoxide can cause headaches, dizziness, drowsiness, nausea, confusion, and eventually death.

Carbon Monoxide is a colorless, odorless, tasteless gas which may be present even if you do not see or smell any engine exhaust. Deadly levels of carbon monoxide can collect rapidly and you can quickly be overcome and

SAFETY INFORMATION

1

unable to save yourself. Also, deadly levels of carbon monoxide can linger for hours or days in enclosed or poorly ventilated areas. If you experience any symptoms of carbon monoxide poisoning, leave the area immediately, get fresh air, and SEEK MEDICAL TREATMENT.

- Do not run engine indoors. Even if you try to ventilate engine exhaust with fans or open windows and doors, carbon monoxide can rapidly reach dangerous levels.
- Do not run engine in poorly ventilated or partially enclosed areas such as barns, garages, or carports.
- Do not run engine outdoors where engine exhaust can be drawn into a building through openings such as windows and doors.

Loading

Adding accessories or cargo to your motorcycle can adversely affect stability and handling if the weight distribution of the motorcycle is changed. To avoid the possibility of an accident, use extreme caution when adding cargo or

accessories to your motorcycle. Use extra care when riding a motorcycle that has added cargo or accessories. Here, along with the information about accessories below, are some general guidelines to follow if loading cargo to your motorcycle:

The total weight of the operator, accessories and cargo must not exceed the maximum load limit. **Operation of an overloaded vehicle could cause an accident.**

Maximum load:
90 kg (198 lb)

When loading within this weight limit, keep the following in mind:

- Shifting weights can create a sudden imbalance. Make sure that accessories are securely attached to the motorcycle before riding. Check accessory mounts frequently.
- Properly adjust the suspension for your load (suspension-adjustable models only), and check the condition and pressure of your tires.

- Never attach any large or heavy items to the handlebar, front fork, or front fender. These items, including such cargo as sleeping bags, duffel bags, or tents, can create unstable handling or a slow steering response.
- **This vehicle is not designed to pull a trailer or to be attached to a sidecar.**

Genuine Yamaha Accessories

Choosing accessories for your vehicle is an important decision. Genuine Yamaha accessories, which are available only from a Yamaha dealer, have been designed, tested, and approved by Yamaha for use on your vehicle.

Many companies with no connection to Yamaha manufacture parts and accessories or offer other modifications for Yamaha vehicles. Yamaha is not in a position to test the products that these aftermarket companies produce. Therefore, Yamaha can neither endorse nor recommend the use of accessories not sold by Yamaha or modifications not specifically recom-



mended by Yamaha, even if sold and installed by a Yamaha dealer.

Aftermarket Parts, Accessories, and Modifications

While you may find aftermarket products similar in design and quality to genuine Yamaha accessories, recognize that some aftermarket accessories or modifications are not suitable because of potential safety hazards to you or others. Installing aftermarket products or having other modifications performed to your vehicle that change any of the vehicle's design or operation characteristics can put you and others at greater risk of serious injury or death. You are responsible for injuries related to changes in the vehicle.

Keep the following guidelines in mind, as well as those provided under "Loading" when mounting accessories.

- Never install accessories that would impair the performance of your motorcycle. Carefully inspect the accessory before using it to make sure that it does not in any way reduce ground clearance or cornering clearance, limit suspen-

sion travel, steering travel or control operation, or obscure lights or reflectors.

- Accessories fitted to the handlebar or the front fork area can create instability due to improper weight distribution. If accessories are added to the handlebar or front fork area, they must be as lightweight as possible and should be kept to a minimum.
- Bulky or large accessories may seriously affect the stability of the motorcycle. Wind may attempt to lift the motorcycle, or the motorcycle may become unstable in cross winds.
- Certain accessories can displace the operator from his or her normal riding position. This improper position limits the freedom of movement of the operator and may limit control ability, therefore, such accessories are not recommended.
- Use caution when adding electrical accessories. If electrical accessories exceed the capacity of the motorcycle's electrical system, an

electric failure could result, which could cause a dangerous loss of lights or engine power.

Aftermarket Tires and Rims

The tires and rims that came with your motorcycle were designed to match the performance capabilities and to provide the best combination of handling, braking, and comfort. Other tires, rims, sizes, and combinations may not be appropriate. Refer to page 6-18 for tire specifications and more information on replacing your tires.

Transporting the Motorcycle

Be sure to observe following instructions before transporting the motorcycle in another vehicle.

- Remove all loose items from the motorcycle.
- Point the front wheel straight ahead on the trailer or in the truck bed, and choke it in a rail to prevent movement.
- Shift the transmission in gear (for models with a manual transmission).
- Secure the motorcycle with



SAFETY INFORMATION

1

tie-downs or suitable straps that are attached to solid parts of the motorcycle, such as the frame or upper front fork triple clamp (and not, for example, to rubber-mounted handlebars or turn signals, or parts that could break). Choose the location for the straps carefully so the straps will not rub against painted surfaces during transport.

- The suspension should be compressed somewhat by the tie-downs, if possible, so that the motorcycle will not bounce excessively during transport.

Left view

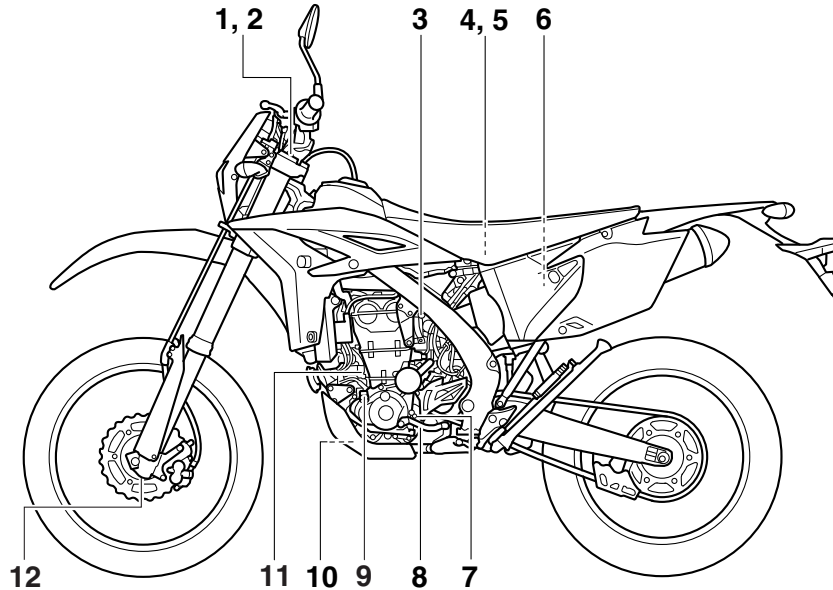

1. Front fork compression damping force adjusting screw (page 3-14)
2. Bleed screw (page 3-15)
3. Starter knob (page 3-12)
4. Battery (page 6-30)
5. Main fuse (page 6-32)
6. Air filter element (page 6-14)
7. Engine oil check bolt (page 6-8)
8. Shift pedal (page 3-8)
9. Engine oil filler cap (page 6-8)
10. Engine oil drain bolt (oil tank) (page 6-8)
11. Engine oil tank cap (page 6-8)
12. Front fork rebound damping force adjusting screw (page 3-14)

DESCRIPTION

EAU10420

Right view

2

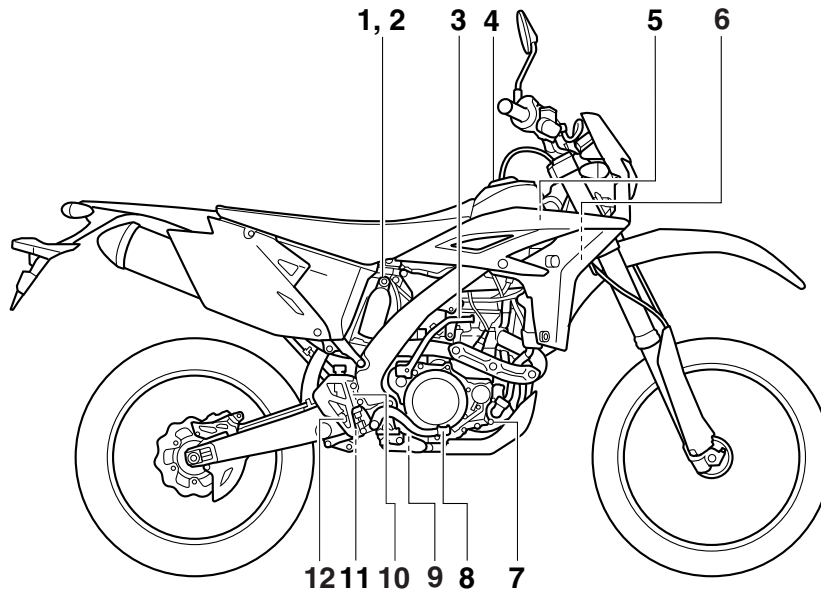

1. Shock absorber assembly compression damping force adjusting screw (for slow compression damping) (page 3-16)
2. Shock absorber assembly compression damping force adjusting nut (for fast compression damping) (page 3-16)
3. Kickstarter (page 3-12)
4. Fuel tank cap (page 3-9)
5. Radiator cap (page 6-12)
6. Steering lock (page 3-13)
7. Coolant drain bolt (page 6-13)
8. Brake pedal (page 3-9)
9. Engine oil drain bolt (crankcase) (page 6-8)
10. Rear brake fluid reservoir (page 6-23)
11. Shock absorber assembly rebound damping force adjusting screw (page 3-16)
12. Rear brake light switch (page 6-22)

Controls and instruments

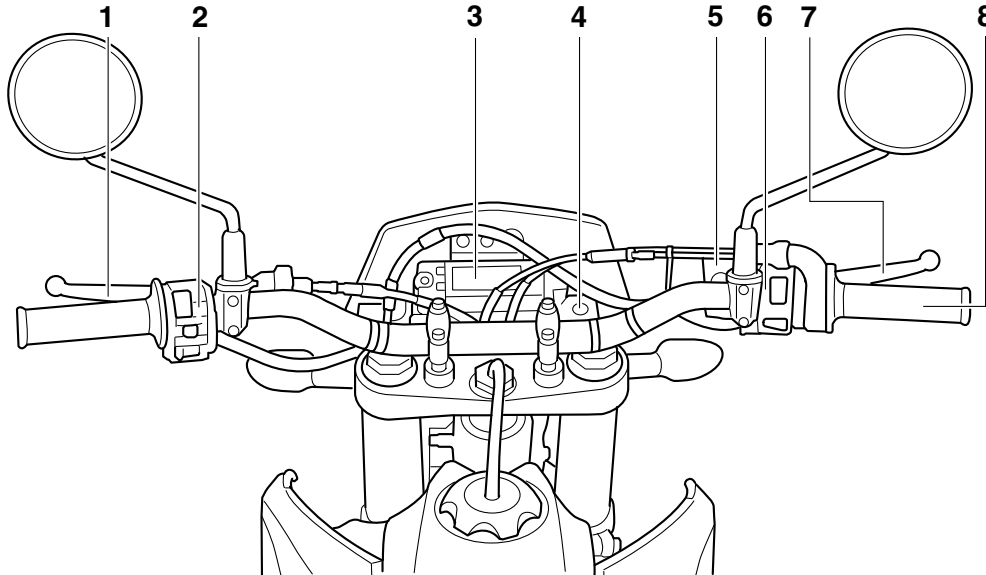

1. Clutch lever (page 3-8)
2. Left handlebar switches (page 3-7)
3. Multi-function display (page 3-2)
4. Main switch (page 3-1)
5. Front brake fluid reservoir (page 6-23)
6. Right handlebar switches (page 3-7)
7. Brake lever (page 3-8)

8. Throttle grip (page 6-17)

INSTRUMENT AND CONTROL FUNCTIONS

Main switch

EAU10451

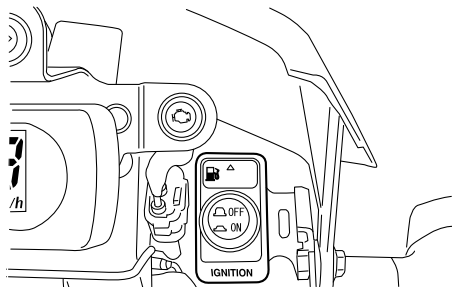

3

The main switch controls the ignition and lighting systems. The various main switch positions are described below.

ON

EAU52430

All electrical circuits are supplied with power; the meter lighting, taillight, license plate light and auxiliary light come on, and the engine can be started.

TIP

The headlight comes on automatically when the engine is started and stays on until the main switch is pushed to "OFF", even if the engine stalls.

OFF

All electrical systems are off.

EAU52471

EWA16130

WARNING

Never push the main switch to "OFF" while the vehicle is moving, otherwise the electrical systems will be switched off, which may result in loss of control or an accident.

ECA17830

NOTICE

Make sure that the main switch is in "OFF" with the engine turned off, otherwise the battery may discharge to the point that the starter motor will not operate properly.

Indicator lights and warning lights

EAU49393

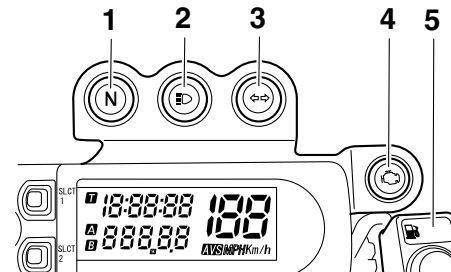

1. Neutral indicator light "N"
2. High beam indicator light "≡"
3. Turn signal indicator light "← →"
4. Engine trouble warning light "engine icon"
5. Fuel level warning light "fuel tank icon"

EAU11020

Turn signal indicator light "← →"

This indicator light flashes when the turn signal switch is pushed to the left or right.

EAU11060

Neutral indicator light "N"

This indicator light comes on when the transmission is in the neutral position.

INSTRUMENT AND CONTROL FUNCTIONS

High beam indicator light “”

EAU11080

This indicator light comes on when the high beam of the headlight is switched on.

Fuel level warning light “”

EAU52390

This warning light comes on when the fuel level drops below approximately 3.0 L (0.79 US gal, 0.66 Imp.gal). When this occurs, refuel as soon as possible. The electrical circuit of the warning light can be checked by pushing the main switch to “ON”. The warning light should come on for a few seconds, and then go off.

If the warning light does not come on initially when the main switch is pushed to “ON”, or if the warning light remains on, have a Yamaha dealer check the electrical circuit.

Engine trouble warning light “”

EAU52400

This warning light comes on or flashes if a problem is detected in the electrical circuit monitoring the engine. If this occurs, have a Yamaha dealer check the vehicle.

The electrical circuit of the warning light can be checked by pushing the main switch to “ON”. The warning light should come on for a few seconds, and then go off.

If the warning light does not come on initially when the main switch is pushed to “ON”, or if the warning light remains on, have a Yamaha dealer check the electrical circuit.

Multi-function display

EAU52922

EWA12312

WARNING

Be sure to stop the vehicle before making any setting changes to the multi-function display. Changing settings while riding can distract the operator and increase the risk of an accident.

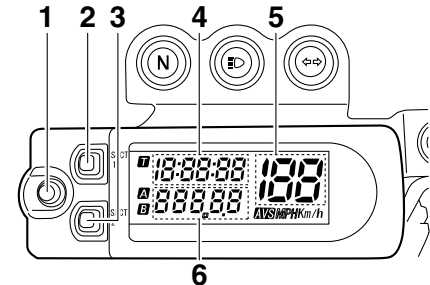

1. “RST” button
2. “SLCT 1” button
3. “SLCT 2” button
4. Clock/stopwatch
5. Speedometer
6. Odometer/tripmeter

INSTRUMENT AND CONTROL FUNCTIONS

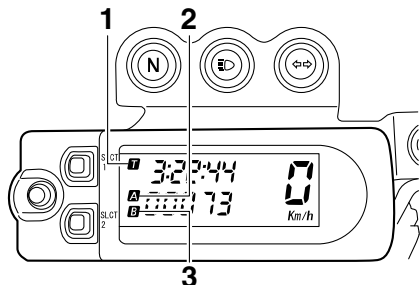

1. Stopwatch indicator “**T**”
2. Tripmeter A indicator “**A**”/Distance-compensation tripmeter “**A**”
3. Tripmeter B indicator “**B**”

TIP

- The multi-function display can be set to the basic mode or the measurement mode.
- Tripmeter A will automatically reset to zero when changing from the basic mode to the measurement mode or vice versa.

Basic mode:

- a speedometer
- an odometer
- two tripmeters (which show the distance traveled since they were

- last set to zero)
- a clock

Measurement mode:

- a speedometer
- a distance-compensation tripmeter (which shows the accumulated distance traveled since set to zero and which can be calibrated to provide a more accurate tripmeter reading)
- a stopwatch (which shows the time that has been accumulated since the start of stopwatch measurement)

TIP

- Be sure to push the main switch to “ON” before using the “SLCT 1”, “SLCT 2” and “RST” buttons.
- When the main switch is pushed to “ON”, all of the display segments of the multi-function display will appear and then disappear, in order to test the electrical circuit.
- For the U.K. only: To switch the speedometer and odometer/tripmeter displays between kilometers and miles, press the “SLCT 2” but-

ton until the display changes after the main switch is pushed to “ON”.

Basic mode

Odometer and tripmeter modes

Push the “SLCT 2” button to switch the display between the odometer mode and the tripmeter modes A and B in the following order:

odometer → tripmeter A → tripmeter B → odometer

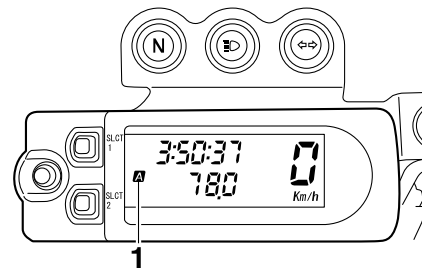

1. Tripmeter A indicator “**A**”

INSTRUMENT AND CONTROL FUNCTIONS

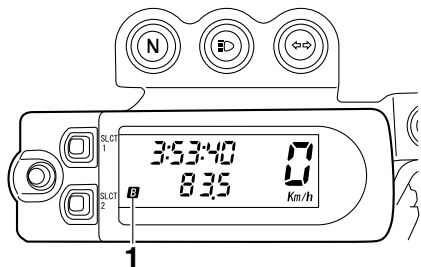

1. Tripmeter B indicator “**B**”

TIP

Indicator “**A**” comes on when tripmeter A is selected, and indicator “**B**” comes on when tripmeter B is selected.

To reset a tripmeter, select it by pushing the “SLCT 2” button, and then push the “RST” button for at least one second.

Clock

The clock displays when the main switch is pushed to “ON”.

To set the clock

1. Push the “SLCT 1” button for at least two seconds.
2. When the hour digits start flashing,

push either select button to set the hours.

3. Push the “RST” button, and the minute digits will start flashing.
4. Push either select button to set the minutes.
5. Push the “RST” button, and the second digits will start flashing.
6. Push either select button to set the second digits to zero.
7. Push the “RST” button for at least two seconds, and then release it to start the clock.

TIP

- When setting the clock, push the “SLCT 1” button to increase the digits or “SLCT 2” button to decrease the digits. Pushing and holding either button will increase or decrease the digits continuously until the button is released.
- If a button is not pushed within 30 seconds while setting the clock, the clock will be set to the currently displayed time.

Changing from the basic mode to the measurement mode

With the odometer selected, push the “SLCT 1” button and “SLCT 2” button together for at least two seconds to change to the measurement mode.

Changing from the measurement mode to the basic mode

TIP

The stopwatch must be stopped before changing to the basic mode.

1. Check that the stopwatch is not in operation. If the stopwatch is in operation, stop it by pushing the “SLCT 1” button and “SLCT 2” button together.
2. Push the “SLCT 1” button and “SLCT 2” button together for at least two seconds to change to the basic mode.

Measurement mode (for the stopwatch)

When the measurement mode is selected, the stopwatch is displayed and it can be started manually or automatically.

INSTRUMENT AND CONTROL FUNCTIONS

TIP

Starting measurement consists of the following two starts, either of which can be selected.

- Manual start

Starting measurement by the rider himself operating the button. (A long push on the “SLCT 2” button will put measurement on standby.)

- Auto start

Starting timer measurement automatically on detection of the movement of the machine. (A long push on the “SLCT 1” button will put measurement on standby.)

Manual start

The manual start is the default setting for the stopwatch. The stopwatch indicator “**I**” and the distance-compensation tripmeter indicator “**A**” will start flashing.

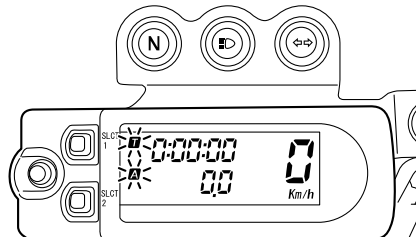

1. Push the “RST” button to start the stopwatch.
2. Push the “SLCT 1” button and “SLCT 2” button together to stop the stopwatch.
3. To resume stopwatch counting, push the “SLCT 1” button and “SLCT 2” button together.
To reset the stopwatch to zero, push the “RST” button for at least two seconds.

TIP

The stopwatch will continue counting when the vehicle is stopped. To stop and/or resume counting, repeat steps 2 and 3.

Auto start

1. Push the “SLCT 1” button for at least two seconds to set the auto start.

TIP

When the stopwatch is set to auto start, the stopwatch indicator “**I**” and the distance-compensation tripmeter indicator “**A**” will start flashing, and the digits in the display will start scrolling from left to right.

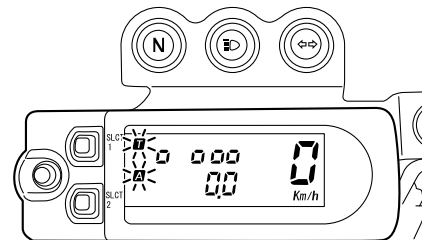

2. When the vehicle starts moving, the stopwatch will start counting.
3. Push the “SLCT 1” button and “SLCT 2” button together to stop the stopwatch.
4. To resume counting, push the “SLCT 1” button and “SLCT 2” but-

ton together again.

TIP

The stopwatch will continue counting when the vehicle is stopped. To stop and/or resume counting, repeat steps 3 and 4.

Measurement mode (for calibrating the distance-compensation tripmeter's reading)

The distance-compensation tripmeter is a feature intended to provide a more accurate tripmeter reading for enduro riding. Calibrating this meter in accordance with the distances specified on the enduro course map will help familiarize the rider with the course. In addition, calibrating the meter may also be necessary when using tire, wheel, chain sprocket sizes, etc. other than specified. For further information concerning the use of this meter, please consult your nearby Yamaha dealer.

Calibrate the distance-compensation tripmeter as follows.

To increase the reading, push the "SLCT 1" button. To decrease the reading, push the "SLCT 2" button. Pushing

and holding either button will increase or decrease the reading continuously until the button is released.

TIP

Calibrating the reading of the distance-compensation tripmeter is possible regardless of the stopwatch operation.

Resetting the distance-compensation tripmeter or the distance-compensation tripmeter in combination with the stopwatch

TIP

Resetting can be made only to the distance-compensation tripmeter or to the distance-compensation tripmeter in combination with the stopwatch.

Resetting the distance-compensation tripmeter

1. Check that the stopwatch measurement is in operation.
2. Reset the distance-compensation tripmeter to zero by pushing the "RST" button for at least two seconds.

Resetting the distance-compensation tripmeter in combination with the stopwatch

1. Stop the stopwatch.
2. Reset the distance-compensation tripmeter and the stopwatch to zero by pushing the "RST" button for at least two seconds.

INSTRUMENT AND CONTROL FUNCTIONS

Handlebar switches

Left

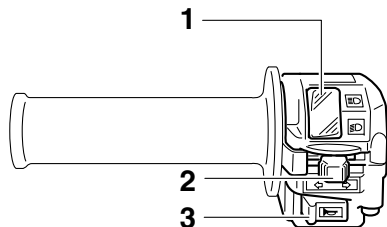

1. Dimmer switch “ $\equiv \circ / \equiv \circ$ ”
2. Turn signal switch “ \leftarrow / \rightarrow ”
3. Horn switch “ H ”

Right

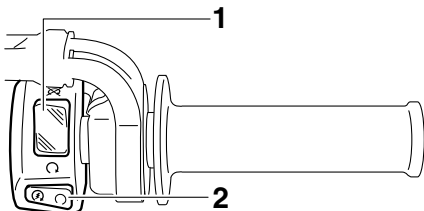

1. Engine stop switch “ \circ / \otimes ”
2. Start switch “ \otimes ”

EAU1234C

Dimmer switch “ $\equiv \circ / \equiv \circ$ ”

Set this switch to “ $\equiv \circ$ ” for the high beam and to “ \otimes ” for the low beam.

EAU12400

Turn signal switch “ \leftarrow / \rightarrow ”

To signal a right-hand turn, push this switch to “ \rightarrow ”. To signal a left-hand turn, push this switch to “ \leftarrow ”. When released, the switch returns to the center position. To cancel the turn signal lights, push the switch in after it has returned to the center position.

EAU12460

Horn switch “ H ”

Press this switch to sound the horn.

EAU12500

Engine stop switch “ \circ / \otimes ”

Set this switch to “ \circ ” before starting the engine. Set this switch to “ \otimes ” to stop the engine in case of an emergency, such as when the vehicle overturns or when the throttle cable is stuck.

EAU12660

Start switch “ \otimes ”

Push this switch to crank the engine

EAU12711

with the starter. See page 5-1 for starting instructions prior to starting the engine.

EAU52440

The engine trouble warning light will come on when the main switch is pushed to “ON” and the start switch is pushed, but this does not indicate a malfunction.

EAU12820

Clutch lever

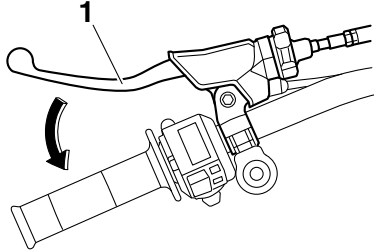

1. Clutch lever

The clutch lever is located at the left handlebar grip. To disengage the clutch, pull the lever toward the handlebar grip. To engage the clutch, release the lever. The lever should be pulled rapidly and released slowly for smooth clutch operation.

The clutch lever is equipped with a clutch switch, which is part of the ignition circuit cut-off system. (See page 3-19.)

EAU12871

Shift pedal

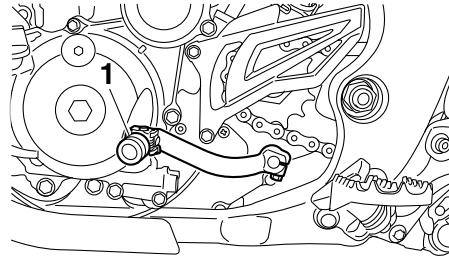

1. Shift pedal

The shift pedal is located on the left side of the motorcycle and is used in combination with the clutch lever when shifting the gears of the 5-speed constant-mesh transmission equipped on this motorcycle.

EAU41264

Brake lever

The brake lever is located on the right side of the handlebar. To apply the front brake, pull the lever toward the throttle grip.

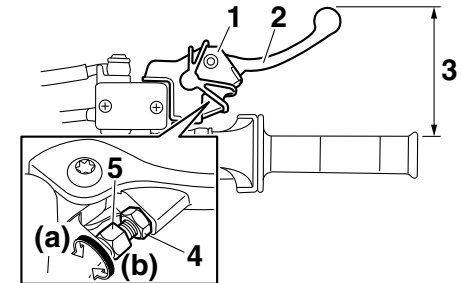

1. Rubber cover
2. Brake lever
3. Distance between brake lever and throttle grip
4. Locknut
5. Brake lever position adjusting bolt

The brake lever is equipped with a brake lever position adjusting bolt. Adjust the distance between the brake lever and the throttle grip as follows.

1. Slide the rubber cover toward the end of the brake lever.
2. Loosen the locknut.

INSTRUMENT AND CONTROL FUNCTIONS

3. While holding the lever pushed away from the throttle grip, turn the adjusting bolt in direction (a) to increase the distance, and in direction (b) to decrease it.

Distance between the brake lever and the throttle grip:

- Minimum (shortest):
76 mm (2.99 in)
- Standard:
95 mm (3.74 in)
- Maximum (longest):
97 mm (3.82 in)

4. Tighten the locknut.
5. Slide the rubber cover to its original position.

Brake pedal

EAU12941

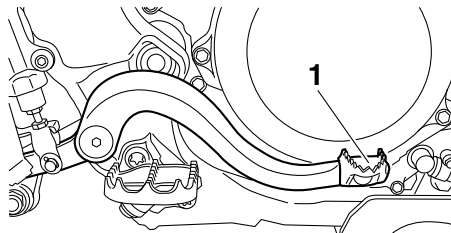

1. Brake pedal

The brake pedal is on the right side of the motorcycle. To apply the rear brake, press down on the brake pedal.

Fuel tank cap

EAU13182



1. Fuel tank cap

To remove the fuel tank cap, turn it counterclockwise, and then pull it off. To install the fuel tank cap, insert it into the tank opening, and then turn it clockwise.

WARNING

Make sure that the fuel tank cap is properly closed after filling fuel. Leaking fuel is a fire hazard.

EWA11091

INSTRUMENT AND CONTROL FUNCTIONS

Fuel

Make sure there is sufficient gasoline in the tank.

EAU13212

EWA10881

WARNING

Gasoline and gasoline vapors are extremely flammable. To avoid fires and explosions and to reduce the risk of injury when refueling, follow these instructions.

1. Before refueling, turn off the engine and be sure that no one is sitting on the vehicle. Never refuel while smoking, or while in the vicinity of sparks, open flames, or other sources of ignition such as the pilot lights of water heaters and clothes dryers.
2. Do not overfill the fuel tank. Stop filling when the fuel reaches the bottom of the filler tube. Because fuel expands when it heats up, heat from the engine or the sun can cause fuel to spill out of the fuel tank.

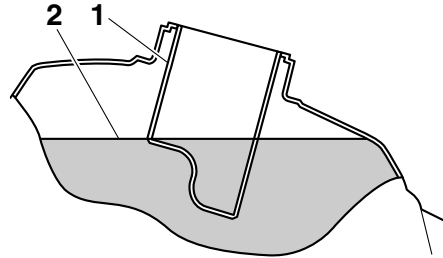

1. Fuel tank filler tube
2. Maximum fuel level
3. Wipe up any spilled fuel immediately. **NOTICE: Immediately wipe off spilled fuel with a clean, dry, soft cloth, since fuel may deteriorate painted surfaces or plastic parts.**^[ECA10071]
4. Be sure to securely close the fuel tank cap.

EWA15151

WARNING

Gasoline is poisonous and can cause injury or death. Handle gasoline with care. Never siphon gasoline by mouth. If you should swallow some gasoline or inhale a lot of gasoline vapor, or get some gasoline in

your eyes, see your doctor immediately. If gasoline spills on your skin, wash with soap and water. If gasoline spills on your clothing, change your clothes.

EAU13391

Recommended fuel:

Premium unleaded gasoline only

Fuel tank capacity:

7.2 L (1.90 US gal, 1.58 Imp.gal)

Fuel reserve amount (when the fuel level warning light comes on):

3.0 L (0.79 US gal, 0.66 Imp.gal)

ECA11400

NOTICE

Use only unleaded gasoline. The use of leaded gasoline will cause severe damage to internal engine parts, such as the valves and piston rings, as well as to the exhaust system.

Your Yamaha engine has been designed to use premium unleaded gasoline with a research octane number of 95 or higher. If knocking (or pinging) occurs, use a gasoline of a different brand. Use of unleaded fuel will extend

INSTRUMENT AND CONTROL FUNCTIONS

spark plug life and reduce maintenance costs.

3

Fuel tank breather hose

EAU41360



1. Fuel tank breather hose
2. One-way valve

Before operating the motorcycle:

- Check the fuel tank breather hose connection.
- Check the fuel tank breather hose for cracks or damage, and replace it if damaged.
- Make sure that the end of the fuel tank breather hose is not blocked, and clean it if necessary.

TIP

If the fuel tank breather hose falls out, reinstall it on the fuel tank cap with the arrow mark on the one-way valve pointed downward as shown.

EAU13433

Catalytic converter

This model is equipped with a catalytic converter in the exhaust system.

EWA10862

⚠ WARNING

The exhaust system is hot after operation. To prevent a fire hazard or burns:

- Do not park the vehicle near possible fire hazards such as grass or other materials that easily burn.
- Park the vehicle in a place where pedestrians or children are not likely to touch the hot exhaust system.
- Make sure that the exhaust system has cooled down before doing any maintenance work.
- Do not allow the engine to idle more than a few minutes. Long idling can cause a build-up of heat.

ECA10701

NOTICE

Use only unleaded gasoline. The use of leaded gasoline will cause unreparable damage to the catalytic

converter.

EAU53230

EAU13650

Starter knob

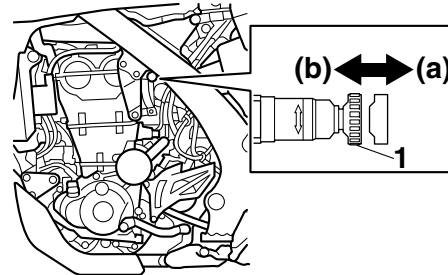

1. Starter knob/idle adjusting screw

Starting a cold engine requires a richer air-fuel mixture, which is supplied by the starter.

Move the knob in direction (a) to turn on the starter.

Move the knob in direction (b) to turn off the starter.

Kickstarter

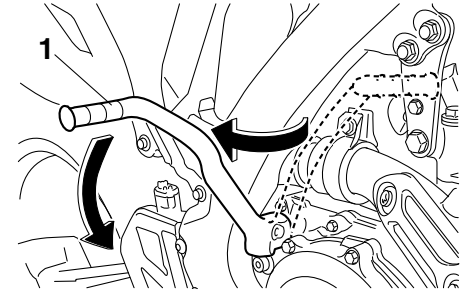

1. Kickstarter lever

To start the engine, fold out the kickstarter lever, move it down lightly with your foot until the gears engage, and then push it down smoothly but forcefully. This model is equipped with a primary kickstarter, allowing the engine to be started in any gear if the clutch is disengaged. However, shifting the transmission into the neutral position before starting is recommended.

INSTRUMENT AND CONTROL FUNCTIONS

EAU53100

Steering lock

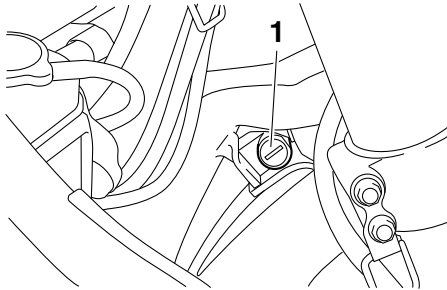

1. Steering lock

To lock the steering

1. Turn the handlebar all the way to the left.
2. Insert the key into the steering lock under the steering head pipe, and then turn it 1/2 turn in either direction.
3. Check that the steering is locked, and then remove the key from the lock.

To unlock the steering

1. Insert the key into the steering lock.
2. Turn the key 1/2 turn in either di-

- rection.
3. Remove the key. **WARNING! Never ride with the key inserted into the steering lock, which may result in loss of control and an accident.**^[EWA16160]

EAU53200

Seat

To remove the seat

Remove the bolts, and then slide the seat to the rear and pull upward.

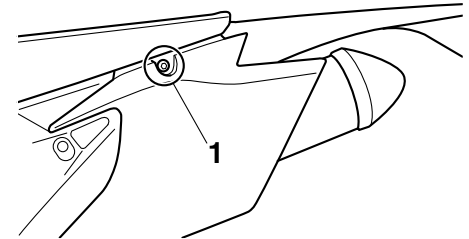

1. Bolt

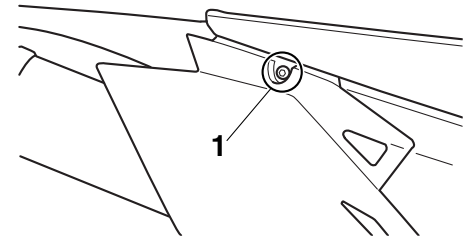

1. Bolt

To install the seat

1. Fit the slot in the seat onto the projection on the fuel tank.

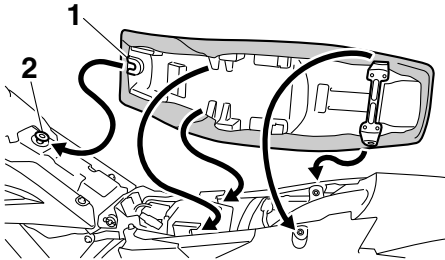

1. Slot
2. Projection

2. Place the seat in the original position, and then tighten the bolts.

TIP

Make sure that the seat is properly secured before riding.

Adjusting the front fork

EAU52450

EWA10180

WARNING

Always adjust both fork legs equally, otherwise poor handling and loss of stability may result.

This front fork is equipped with rebound damping force adjusting screws and compression damping force adjusting screws.

ECA10101

NOTICE

To avoid damaging the mechanism, do not attempt to turn beyond the maximum or minimum settings.

Rebound damping force

To increase the rebound damping force and thereby harden the rebound damping, turn the adjusting screw on each fork leg in direction (a). To decrease the rebound damping force and thereby soften the rebound damping, turn the adjusting screw on each fork leg in direction (b).

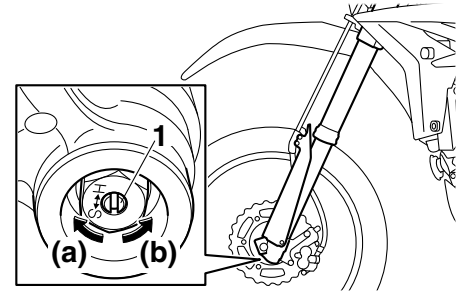

1. Rebound damping force adjusting screw

Rebound damping setting:

Minimum (soft):

20 click(s) in direction (b)*

Standard:

12 click(s) in direction (b)*

Maximum (hard):

0 click(s) in direction (b)*

* With the adjusting screw fully turned in direction (a)

Compression damping force

To increase the compression damping force and thereby harden the compression damping, turn the adjusting screw on each fork leg in direction (a). To decrease the compression damping force and thereby soften the compression damping, turn the adjusting screw on

INSTRUMENT AND CONTROL FUNCTIONS

each fork leg in direction (b).

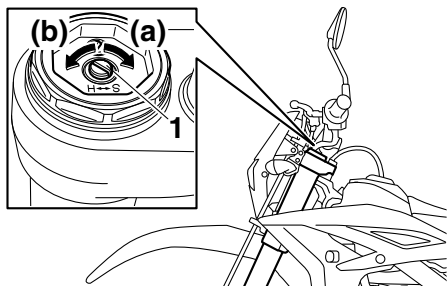

1. Compression damping force adjusting screw

Compression damping setting:

Minimum (soft):

20 click(s) in direction (b)*

Standard:

14 click(s) in direction (b)*

Maximum (hard):

0 click(s) in direction (b)*

* With the adjusting screw fully turned in direction (a)

TIP

Although the total number of clicks of a damping force adjusting mechanism may not exactly match the above specifications due to small differences in production, the actual number of clicks always represents the entire adjusting

range. To obtain a precise adjustment, it would be advisable to check the number of clicks of each damping force adjusting mechanism and to modify the specifications as necessary.

EAU14793

EWA10200

Front fork bleeding

! WARNING

Always bleed both fork legs, otherwise poor handling and loss of stability may result.

When riding in extremely rough conditions, the air temperature and pressure in the front fork will rise. This will increase the spring preload and harden the front suspension. If this occurs, bleed the front fork as follows.

1. Lift the front wheel off the ground according to the procedure on page 6-36.

TIP

When bleeding the front fork, there should be no weight on the front end of the vehicle.

2. Remove the bleed screws and allow all of the air to escape from each fork leg.

EAU52892

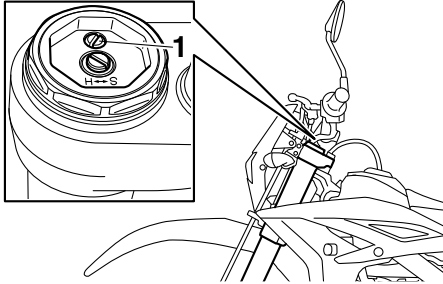

1. Bleed screw

3. Install the bleed screws.
4. Lower the front wheel so that it is on the ground, and then put the sidestand down.

Adjusting the shock absorber assembly

This shock absorber assembly is equipped with a spring preload adjusting ring, a rebound damping force adjusting screw, a compression damping force adjusting bolt (for fast compression damping) and a compression damping force adjusting screw (for slow compression damping).

ECA10101

NOTICE

To avoid damaging the mechanism, do not attempt to turn beyond the maximum or minimum settings.

Spring preload

Spring preload adjustment should be made by a Yamaha dealer, since this service requires special tools and technical skills. The specified settings are listed below.

The spring preload setting is determined by measuring distance A, shown in the illustration. The shorter the distance A is, the higher the spring preload; the longer distance A is, the lower

the spring preload.

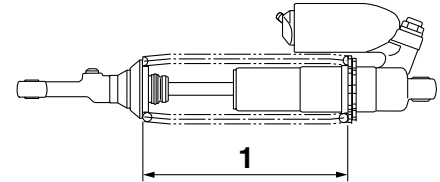

1. Distance A

Spring preload:

- Minimum (soft):
Distance A = 238.5 mm (9.39 in)
- Standard:
Distance A = 222 mm (8.74 in)
- Maximum (hard):
Distance A = 222 mm (8.74 in)

Rebound damping force

To increase the rebound damping force and thereby harden the rebound damping, turn the adjusting screw in direction (a). To decrease the rebound damping force and thereby soften the rebound damping, turn the adjusting screw in direction (b).

INSTRUMENT AND CONTROL FUNCTIONS

3

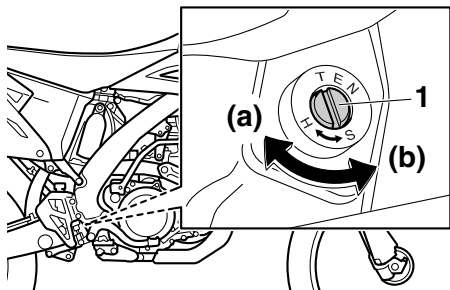

1. Rebound damping force adjusting screw

Rebound damping setting:

Minimum (soft):

30 click(s) in direction (b)*

Standard:

18 click(s) in direction (b)*

Maximum (hard):

0 click(s) in direction (b)*

* With the adjusting screw fully turned in direction (a)

Compression damping force

Compression damping force (for fast compression damping)

To increase the compression damping force and thereby harden the compression damping, turn the adjusting bolt in direction (a). To decrease the compression

damping force and thereby soften the compression damping, turn the adjusting bolt in direction (b).

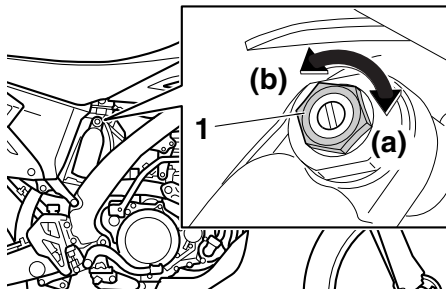

1. Compression damping force adjusting bolt (for fast compression damping)

Compression damping setting (for fast compression damping):

Minimum (soft):

2 turn(s) in direction (b)*

Standard:

7/8 turn(s) in direction (b)*

Maximum (hard):

0 turn(s) in direction (b)*

* With the adjusting bolt fully turned in direction (a)

Compression damping force (for slow compression damping)

To increase the compression damping force and thereby harden the compression

damping, turn the adjusting screw in direction (a). To decrease the compression damping force and thereby soften the compression damping, turn the adjusting screw in direction (b).

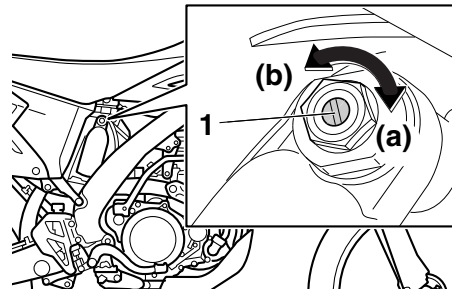

1. Compression damping force adjusting screw (for slow compression damping)

Compression damping setting (for slow compression damping):

Minimum (soft):

20 click(s) in direction (b)*

Standard:

10 click(s) in direction (b)*

Maximum (hard):

0 click(s) in direction (b)*

* With the adjusting screw fully turned in direction (a)

TIP

To obtain a precise adjustment, it is ad-

visible to check the actual total number of clicks or turns of each damping force adjusting mechanism. This adjustment range may not exactly match the specifications listed due to small differences in production.

EWA10221

WARNING

This shock absorber assembly contains highly pressurized nitrogen gas. Read and understand the following information before handling the shock absorber assembly.

- Do not tamper with or attempt to open the cylinder assembly.
- Do not subject the shock absorber assembly to an open flame or other high heat source. This may cause the unit to explode due to excessive gas pressure.
- Do not deform or damage the cylinder in any way. Cylinder damage will result in poor damping performance.
- Do not dispose of a damaged or worn-out shock absorber assembly yourself. Take the shock

absorber assembly to a Yamaha dealer for any service.

Sidestand

The sidestand is located on the left side of the frame. Raise the sidestand or lower it with your foot while holding the vehicle upright.

TIP

The built-in sidestand switch is part of the ignition circuit cut-off system, which cuts the ignition in certain situations. (See the following section for an explanation of the ignition circuit cut-off system.)

EWA10241

WARNING

The vehicle must not be ridden with the sidestand down, or if the sidestand cannot be properly moved up (or does not stay up), otherwise the sidestand could contact the ground and distract the operator, resulting in a possible loss of control. Yamaha's ignition circuit cut-off system has been designed to assist the operator in fulfilling the responsibility of raising the sidestand before starting off. Therefore, check this system regularly and have a

INSTRUMENT AND CONTROL FUNCTIONS

Yamaha dealer repair it if it does not function properly.

EAU52861

Ignition circuit cut-off system

The ignition circuit cut-off system (comprising the sidestand switch, clutch switch and neutral switch) has the following functions.

- It prevents starting when the transmission is in gear and the sidestand is up, but the clutch lever is not pulled.
- It prevents starting when the transmission is in gear and the clutch lever is pulled, but the sidestand is still down.
- It cuts the running engine when the transmission is in gear and the sidestand is moved down.

Periodically check the operation of the ignition circuit cut-off system according to the following procedure.

INSTRUMENT AND CONTROL FUNCTIONS

With the engine turned off:

1. Move the sidestand down.
2. Make sure that the engine stop switch is set to “○”.
3. Push the main switch to “ON”.
4. Shift the transmission into the neutral position.
5. Push the start switch.

Does the engine start?

YES NO



If a malfunction is noted, have a Yamaha dealer check the system before riding.

The neutral switch may not be working correctly.
The motorcycle should not be ridden until checked by a Yamaha dealer.

With the engine still running:

6. Move the sidestand up.
7. Keep the clutch lever pulled.
8. Shift the transmission into gear.
9. Move the sidestand down.

Does the engine stall?

YES NO

The sidestand switch may not be working correctly.
The motorcycle should not be ridden until checked by a Yamaha dealer.

After the engine has stalled:

10. Move the sidestand up.
11. Keep the clutch lever pulled.
12. Push the start switch.

Does the engine start?

YES NO

The clutch switch may not be working correctly.
The motorcycle should not be ridden until checked by a Yamaha dealer.

The system is OK. **The motorcycle can be ridden.**

FOR YOUR SAFETY – PRE-OPERATION CHECKS

EAU15597

Inspect your vehicle each time you use it to make sure the vehicle is in safe operating condition. Always follow the inspection and maintenance procedures and schedules described in the Owner's Manual.

EWA11151

WARNING

Failure to inspect or maintain the vehicle properly increases the possibility of an accident or equipment damage. Do not operate the vehicle if you find any problem. If a problem cannot be corrected by the procedures provided in this manual, have the vehicle inspected by a Yamaha dealer.

Before using this vehicle, check the following points:

ITEM	CHECKS	PAGE
Fuel	<ul style="list-style-type: none">• Check fuel level in fuel tank.• Refuel if necessary.• Check fuel line for leakage.• Check fuel tank breather hose for obstructions, cracks or damage, and check hose connection.	3-10, 3-11
Engine oil	<ul style="list-style-type: none">• Check oil level in oil tank.• If necessary, add recommended oil to specified level.• Check vehicle for oil leakage.	6-8
Coolant	<ul style="list-style-type: none">• Check coolant level.• If necessary, add recommended coolant to specified level.• Check cooling system for leakage.	6-12
Front brake	<ul style="list-style-type: none">• Check operation.• If soft or spongy, have Yamaha dealer bleed hydraulic system.• Check brake pads for wear.• Replace if necessary.• Check fluid level in reservoir.• If necessary, add specified brake fluid to specified level.• Check hydraulic system for leakage.	6-23

FOR YOUR SAFETY – PRE-OPERATION CHECKS

ITEM	CHECKS	PAGE
Rear brake	<ul style="list-style-type: none"> • Check operation. • If soft or spongy, have Yamaha dealer bleed hydraulic system. • Check brake pads for wear. • Replace if necessary. • Check fluid level in reservoir. • If necessary, add specified brake fluid to specified level. • Check hydraulic system for leakage. 	6-23
Clutch	<ul style="list-style-type: none"> • Check operation. • Lubricate cable if necessary. • Check lever free play. • Adjust if necessary. 	6-20
Throttle grip	<ul style="list-style-type: none"> • Make sure that operation is smooth. • Check throttle grip free play. • If necessary, have Yamaha dealer adjust throttle grip free play and lubricate cable and grip housing. 	6-17, 6-27
Control cables	<ul style="list-style-type: none"> • Make sure that operation is smooth. • Lubricate if necessary. 	6-27
Drive chain	<ul style="list-style-type: none"> • Check chain slack. • Adjust if necessary. • Check chain condition. • Lubricate if necessary. 	6-25, 6-26
Wheels and tires	<ul style="list-style-type: none"> • Check for damage. • Check tire condition and tread depth. • Check air pressure. • Correct if necessary. 	6-18, 6-20
Shift pedal	<ul style="list-style-type: none"> • Make sure that operation is smooth. • Correct if necessary. 	6-22
Brake pedal	<ul style="list-style-type: none"> • Make sure that operation is smooth. • Lubricate pedal pivoting point if necessary. 	6-28
Brake and clutch levers	<ul style="list-style-type: none"> • Make sure that operation is smooth. • Lubricate lever pivoting points if necessary. 	6-27
Sidestand	<ul style="list-style-type: none"> • Make sure that operation is smooth. • Lubricate pivot if necessary. 	6-28

FOR YOUR SAFETY – PRE-OPERATION CHECKS

ITEM	CHECKS	PAGE
Chassis fasteners	<ul style="list-style-type: none">• Make sure that all nuts, bolts and screws are properly tightened.• Tighten if necessary.	—
Instruments, lights, signals and switches	<ul style="list-style-type: none">• Check operation.• Correct if necessary.	—
Sidestand switch	<ul style="list-style-type: none">• Check operation of ignition circuit cut-off system.• If system is not working correctly, have Yamaha dealer check vehicle.	3-18

OPERATION AND IMPORTANT RIDING POINTS

EAU15951

Read the Owner's Manual carefully to become familiar with all controls. If there is a control or function you do not understand, ask your Yamaha dealer.

EWA10271

WARNING

Failure to familiarize yourself with the controls can lead to loss of control, which could cause an accident or injury.

EAU55880

TIP

This model is equipped with:

- a lean angle sensor to stop the engine in case of a turnover. In this case, the multi-function display indicates error code 30, but this is not a malfunction. Push the main switch to "OFF" and then to "ON" to clear the error code. Failing to do so will prevent the engine from starting even though the engine will crank when pushing the start switch.
- an engine auto-stop system. The engine stops automatically if left idling for 20 minutes. In this case, the multi-function display indicates error code 70, but this is not a malfunction. Push the start switch to clear the error code and to restart the engine.

EAU52905

Starting a cold engine

ECA11042

NOTICE

For maximum engine life, never accelerate hard when the engine is cold!

In order for the ignition circuit cut-off system to enable starting, one of the following conditions must be met:

- The transmission is in the neutral position.
- The transmission is in gear with the clutch lever pulled and the sidestand up.

See page 3-19 for more information.

1. Push the main switch to "ON" and make sure that the engine stop switch is set to "O".

The following warning lights should come on for a few seconds, then go off.

- Fuel level warning light
- Engine trouble warning light

ECA17781

NOTICE

If a warning light does not come on initially when the main switch is

OPERATION AND IMPORTANT RIDING POINTS

pushed to “ON”, or if a warning light remains on, see page 3-1 for the corresponding warning light circuit check.

2. Shift the transmission into the neutral position. The neutral indicator light should come on. If not, ask a Yamaha dealer to check the electrical circuit.
3. Turn the starter on and completely close the throttle. (See page 3-12.)
4. Start the engine by pushing the start switch or by pushing the kickstarter lever down.

If the engine fails to start when using the start switch, release it, wait a few seconds, and then try again. Each starting attempt should be as short as possible to preserve the battery. Do not crank the engine more than 10 seconds on any one attempt. If the engine does not start with the starter motor, try using the kickstarter.

ECA17801

NOTICE

If the starter motor will not turn when the start switch is pushed, stop

pushing it immediately in order to avoid placing extra load on the starter motor, and start the engine by using the kickstarter.

TIP

Use the kickstarter when the ambient temperature is below 10 °C (50 °F) or when at high altitude.

5. When the engine is warm, turn the starter off.

TIP

The engine is warm when it responds quickly to the throttle with the starter turned off.

Starting with the kickstarter

When using the kickstarter to start the engine, follow the procedures as described below.

1. Fold out the kickstarter lever, push it down lightly with your foot until resistance is felt.

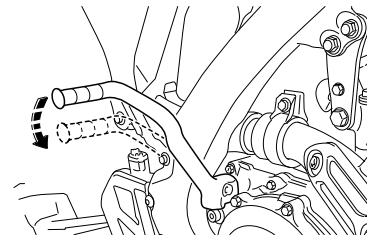

2. With the throttle fully closed, push the kickstarter down lightly until the gears engage, and then push it down smoothly but forcefully.

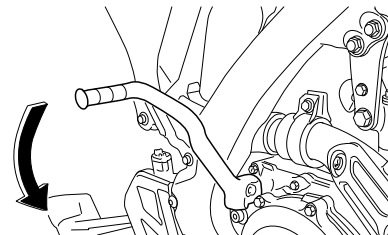

EWA16381

⚠ WARNING

Do not open the throttle while kicking the kickstarter lever. Otherwise, the kickstarter lever may kick back.

OPERATION AND IMPORTANT RIDING POINTS

EAU52971

EAU16671

TIP

If the engine fails to start, push the main switch to “OFF” and give the kickstarter 10 to 20 slow kicks at full throttle in order to clear the engine of the rich air-fuel mixture retained in it.

Starting a warm engine

Follow the same procedure as for starting a cold engine with the exception that the starter is not required when the engine is warm.

TIP

- If the engine does not start at high altitude, start the engine with the throttle grip opened by one degree or two degrees.
- The mark on the throttle housing indicates five degrees. Use the mark for your reference when opening the throttle grip.

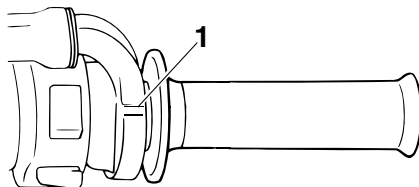

1. Mark

Shifting

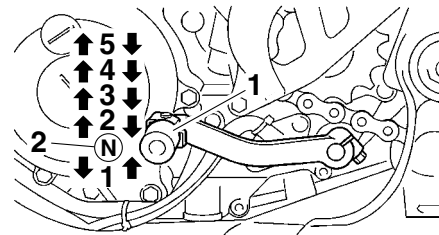

1. Shift pedal
2. Neutral position

Shifting gears lets you control the amount of engine power available for starting off, accelerating, climbing hills, etc.

The gear positions are shown in the illustration.

TIP

To shift the transmission into the neutral position, press the shift pedal down repeatedly until it reaches the end of its travel, and then slightly raise it.

ECA10260

NOTICE

- Even with the transmission in

OPERATION AND IMPORTANT RIDING POINTS

the neutral position, do not coast for long periods of time with the engine off, and do not tow the motorcycle for long distances. The transmission is properly lubricated only when the engine is running. Inadequate lubrication may damage the transmission.

- Always use the clutch while changing gears to avoid damaging the engine, transmission, and drive train, which are not designed to withstand the shock of forced shifting.
-

Tips for reducing fuel consumption

Fuel consumption depends largely on your riding style. Consider the following tips to reduce fuel consumption:

- Shift up swiftly, and avoid high engine speeds during acceleration.
- Do not rev the engine while shifting down, and avoid high engine speeds with no load on the engine.
- Turn the engine off instead of letting it idle for an extended length of time (e.g., in traffic jams, at traffic lights or at railroad crossings).

EAU16810

Engine break-in

EAU52940

EWA10321

WARNING

Failure to properly maintain the vehicle or performing maintenance activities incorrectly may increase your risk of injury or death during service or while using the vehicle. If you are not familiar with vehicle service, have a Yamaha dealer perform service.

1. Before starting the engine, fill the fuel tank with the fuel.
2. Start and warm up the engine. Check the operation of the controls and the engine stop switch. (See page 3-7.) Then, restart the engine and check its operation within no more than 5 minutes after it is restarted.
3. Operate the motorcycle in the lower gears at moderate throttle openings for five to eight minutes. Stop the engine.
4. Check how the engine runs when the motorcycle is ridden with the throttle 1/4 to 1/2 open (low to medium speed) for about one hour.

OPERATION AND IMPORTANT RIDING POINTS

5. Start the engine and check the operation of the motorcycle throughout its entire operating range. Restart the motorcycle and ride it for about 10 to 15 more minutes. The motorcycle will now be ready to ride normally.

After the engine break-in period, thoroughly check the motorcycle for loose parts, oil leakage and any other problems. Be sure to inspect and make adjustments thoroughly, especially cable and drive chain slack and loose spokes. In addition, check all fittings and fasteners for looseness, and tighten if necessary.

ECA15560

NOTICE

- **When any of the following parts have been replaced, they must be broken in.**
Cylinder or crankshaft:
About one hour of break-in operation is necessary.
Piston, rings or transmission gears:
These parts require about 30 minutes of break-in operation at half-throttle or less. Observe the

condition of the engine carefully during operation.

- **If any engine trouble should occur during the engine break-in period, immediately have a Yamaha dealer check the vehicle.**

EAU52410

Parking

When parking, stop the engine by pushing the main switch to "OFF".

EWA10311

WARNING

- **Since the engine and exhaust system can become very hot, park in a place where pedestrians or children are not likely to touch them and be burned.**
- **Do not park on a slope or on soft ground, otherwise the vehicle may overturn, increasing the risk of a fuel leak and fire.**
- **Do not park near grass or other flammable materials which might catch fire.**

PERIODIC MAINTENANCE AND ADJUSTMENT

EAU17244

Periodic inspection, adjustment, and lubrication will keep your vehicle in the safest and most efficient condition possible. Safety is an obligation of the vehicle owner/operator. The most important points of vehicle inspection, adjustment, and lubrication are explained on the following pages.

The intervals given in the periodic maintenance charts should be simply considered as a general guide under normal riding conditions. However, depending on the weather, terrain, geographical location, and individual use, the maintenance intervals may need to be shortened.

WARNING

Failure to properly maintain the vehicle or performing maintenance activities incorrectly may increase your risk of injury or death during service or while using the vehicle. If you are not familiar with vehicle service, have a Yamaha dealer perform service.

EWA10321

EWA15122

WARNING

Turn off the engine when performing maintenance unless otherwise specified.

- **A running engine has moving parts that can catch on body parts or clothing and electrical parts that can cause shocks or fires.**
- **Running the engine while servicing can lead to eye injury, burns, fire, or carbon monoxide poisoning – possibly leading to death. See page 1-2 for more information about carbon monoxide.**

EWA15460

WARNING

Brake discs, calipers, drums, and linings can become very hot during use. To avoid possible burns, let brake components cool before touching them.

EAU17302

Emission controls not only function to ensure cleaner air, but are also vital to proper engine operation and maximum performance. In the following periodic maintenance charts, the services related to emissions control are grouped separately. These services require specialized data, knowledge, and equipment. Maintenance, replacement, or repair of the emission control devices and systems may be performed by any repair establishment or individual that is certified (if applicable). Yamaha dealers are trained and equipped to perform these particular services.

EAU17311

Owner's tool kit

The service information included in this manual and the tools provided in the owner's tool kit are intended to assist you in the performance of preventive maintenance and minor repairs. However, additional tools such as a torque wrench may be necessary to perform certain maintenance work correctly.

TIP _____

If you do not have the tools or experience required for a particular job, have a Yamaha dealer perform it for you.

PERIODIC MAINTENANCE AND ADJUSTMENT

EAU52500

TIP

- The annual checks must be performed every year, except if a kilometer-based maintenance, or for the UK, a mileage-based maintenance, is performed instead.
- From 7000 km (4200 mi) or 9 months, repeat the maintenance intervals starting from 3000 km (1800 mi) or 3 months.
- Items marked with an asterisk should be performed by a Yamaha dealer as they require special tools, data and technical skills.

EAU52510

Periodic maintenance chart for the emission control system

NO.	ITEM	CHECKS AND MAINTENANCE JOBS	INITIAL	ODOMETER READINGS			ANNUAL CHECK
			1000 km (600 mi) or 1 month	3000 km (1800 mi) or 3 months	5000 km (3000 mi) or 6 months		
1	* Fuel line	<ul style="list-style-type: none"> • Check fuel hoses for cracks or damage. 	√	√	√	√	
2	* Spark plug	<ul style="list-style-type: none"> • Check condition. • Clean and regap. • Replace if necessary. 	√	√	√		
3	* Valves	<ul style="list-style-type: none"> • Check valve clearance. • Adjust. 	√		√		
4	* Breather system	<ul style="list-style-type: none"> • Check ventilation hose for cracks or damage and drain any deposits. 	√	√	√		
5	* Fuel injection	<ul style="list-style-type: none"> • Adjust engine idling speed. 	√	√	√	√	
6	Muffler and exhaust pipe	<ul style="list-style-type: none"> • Check the screw clamp(s) for looseness. 	√	√	√		

PERIODIC MAINTENANCE AND ADJUSTMENT

EAU52581

General maintenance and lubrication chart

NO.	ITEM	CHECKS AND MAINTENANCE JOBS	INITIAL	ODOMETER READINGS		ANNUAL CHECK
			1000 km (600 mi) or 1 month	3000 km (1800 mi) or 3 months	5000 km (3000 mi) or 6 months	
1	* Air filter element	<ul style="list-style-type: none"> Clean. Replace if damaged. 	√	√	√	
2	Clutch	<ul style="list-style-type: none"> Check operation. Adjust or replace cable. 	√	√	√	
3	* Front brake	<ul style="list-style-type: none"> Check operation, fluid level and vehicle for fluid leakage. 	√	√	√	√
		<ul style="list-style-type: none"> Replace brake pads. 	Whenever worn to the limit			
4	* Rear brake	<ul style="list-style-type: none"> Check operation, fluid level and vehicle for fluid leakage. 	√	√	√	√
		<ul style="list-style-type: none"> Replace brake pads. 	Whenever worn to the limit			
5	* Brake hoses	<ul style="list-style-type: none"> Check for cracks or damage. Check for correct routing and clamping. 		√	√	
		<ul style="list-style-type: none"> Replace. 	Every 20000 km (12000 mi) or every two years			
6	* Brake fluid	<ul style="list-style-type: none"> Replace. 	Every 2 years			
7	* Wheels	<ul style="list-style-type: none"> Check runout, spoke tightness and for damage. Tighten spokes if necessary. 	√	√	√	
8	* Tires	<ul style="list-style-type: none"> Check tread depth and for damage. Replace if necessary. Check air pressure. Correct if necessary. 	√	√	√	√
9	* Wheel bearings	<ul style="list-style-type: none"> Check bearing for looseness or damage. 	√	√	√	
10	* Swingarm	<ul style="list-style-type: none"> Check operation and for excessive play. Lubricate with lithium-soap-based grease. 	√	√	√	
11	Drive chain	<ul style="list-style-type: none"> Check chain slack, alignment and condition. Adjust and lubricate chain with a special O-ring chain lubricant thoroughly. 	Every ride			
12	* Steering bearings	<ul style="list-style-type: none"> Check bearing play and steering for roughness. Lubricate with lithium-soap-based grease. 	√	√	√	

PERIODIC MAINTENANCE AND ADJUSTMENT

NO.	ITEM	CHECKS AND MAINTENANCE JOBS	INITIAL	ODOMETER READINGS		ANNUAL CHECK
			1000 km (600 mi) or 1 month	3000 km (1800 mi) or 3 months	5000 km (3000 mi) or 6 months	
13	* Chassis fasteners	<ul style="list-style-type: none"> Make sure that all nuts, bolts and screws are properly tightened. 	√	√	√	√
14	Brake lever pivot shaft	<ul style="list-style-type: none"> Lubricate with silicone grease. 	√	√	√	√
15	Brake pedal pivot shaft	<ul style="list-style-type: none"> Lubricate with lithium-soap-based grease. 	√	√	√	√
16	Clutch lever pivot shaft	<ul style="list-style-type: none"> Lubricate with lithium-soap-based grease. 	√	√	√	√
17	Sidestand	<ul style="list-style-type: none"> Check operation. Lubricate with lithium-soap-based grease. 	√	√	√	√
18	* Sidestand switch	<ul style="list-style-type: none"> Check operation. 	√	√	√	√
19	* Front fork	<ul style="list-style-type: none"> Check operation and for oil leakage. 		√	√	
20	* Shock absorber assembly	<ul style="list-style-type: none"> Check operation and shock absorber for oil leakage. 		√	√	
21	* Rear suspension relay arm and connecting arm pivoting points	<ul style="list-style-type: none"> Check operation. 		√	√	
22	Engine oil	<ul style="list-style-type: none"> Change. Check oil level and vehicle for oil leakage. 	√	√	√	√
23	Engine oil filter element	<ul style="list-style-type: none"> Replace. 	√	√	√	√
24	* Cooling system	<ul style="list-style-type: none"> Check hoses for cracks of damage. Replace if necessary. 	√	√	√	√
		<ul style="list-style-type: none"> Check coolant level and vehicle for coolant leakage. 	√	√	√	
		<ul style="list-style-type: none"> Change with ethylene glycol anti-freeze coolant. 	Every 1 year			
25	* Front and rear brake switches	<ul style="list-style-type: none"> Check operation. 	√	√	√	√

PERIODIC MAINTENANCE AND ADJUSTMENT

NO.	ITEM	CHECKS AND MAINTENANCE JOBS	INITIAL	ODOMETER READINGS		ANNUAL CHECK
			1000 km (600 mi) or 1 month	3000 km (1800 mi) or 3 months	5000 km (3000 mi) or 6 months	
26	* Moving parts and cables	<ul style="list-style-type: none"> Lubricate. 	√	√	√	√
27	* Throttle grip	<ul style="list-style-type: none"> Check operation. Check throttle grip free play, and adjust if necessary. Lubricate cable and grip housing. 	√	√	√	√
28	* Lights, signals and switches	<ul style="list-style-type: none"> Check operation. Adjust headlight beam. 	√	√	√	√

EAU53210

TIP

- The air filter needs more frequent service if you are riding in unusually wet or dusty areas.
- Hydraulic brake service
 - Regularly check and, if necessary, correct the brake fluid level.
 - Every two years replace the internal components of the brake master cylinders and calipers, and change the brake fluid.
 - Replace the brake hoses every two years and if cracked or damaged.

PERIODIC MAINTENANCE AND ADJUSTMENT

EAU18751

Removing and installing the panel

The panel shown needs to be removed to perform some of the maintenance jobs described in this chapter. Refer to this section each time the panel needs to be removed and installed.

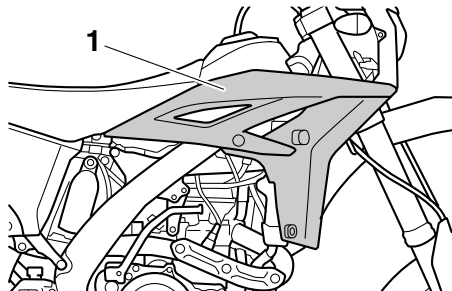

1. Panel A

EAU52872

Panel A

To remove the panel

1. Remove the seat. (See page 3-13.)
2. Remove the bolts.

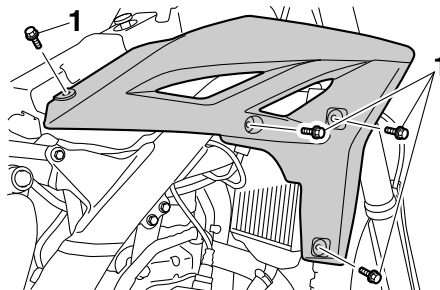

1. Bolt

3. Pull the front part of the panel outward, and then remove the panel by pulling it off.

To install the panel

1. Place the panel in the original position, and then install the bolts.

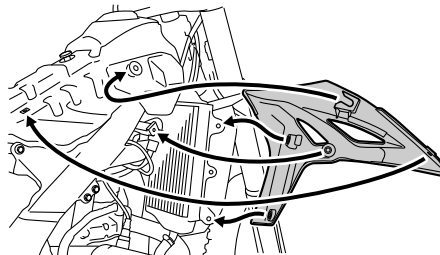

2. Install the seat.

EAU19622

Checking the spark plug

The spark plug is an important engine component, which should be checked periodically, preferably by a Yamaha dealer. Since heat and deposits will cause any spark plug to slowly erode, it should be removed and checked in accordance with the periodic maintenance and lubrication chart. In addition, the condition of the spark plug can reveal the condition of the engine.

The porcelain insulator around the center electrode of the spark plug should be a medium-to-light tan (the ideal color when the vehicle is ridden normally). If the spark plug shows a distinctly different color, the engine could be operating improperly. Do not attempt to diagnose such problems yourself. Instead, have a Yamaha dealer check the vehicle. If the spark plug shows signs of electrode erosion and excessive carbon or other deposits, it should be replaced.

Specified spark plug:
NGK/CR8E

Before installing a spark plug, the spark plug gap should be measured with a

PERIODIC MAINTENANCE AND ADJUSTMENT

EAU52964

wire thickness gauge and, if necessary, adjusted to specification.

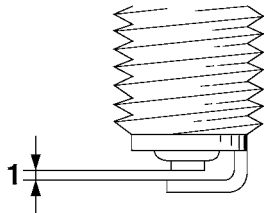

1. Spark plug gap

Spark plug gap:

0.7–0.8 mm (0.028–0.031 in)

Clean the surface of the spark plug gasket and its mating surface, and then wipe off any grime from the spark plug threads.

Tightening torque:

Spark plug:

13 Nm (1.3 m·kgf, 9.4 ft·lbf)

TIP _____

If a torque wrench is not available when installing a spark plug, a good estimate of the correct torque is 1/4–1/2 turn

past finger tight. However, the spark plug should be tightened to the specified torque as soon as possible.

Engine oil and oil filter element

The engine oil level should be checked before each ride. In addition, the oil must be changed and the oil filter element replaced at the intervals specified in the periodic maintenance and lubrication chart. A slight tilt to the side can result in a false reading.

To check the engine oil level

1. Place the vehicle on a level surface and hold it in an upright position.
2. Start the engine, warm it up for several minutes, and then turn it off.
3. Wait a few minutes until the oil settles, remove the engine oil tank cap, wipe the dipstick clean, insert it back into the oil tank (without screwing it in), and then remove it again to check the oil level.

WARNING! Never remove the engine oil tank cap after high-speed operation, otherwise hot engine oil could spout out and cause damage or injury.

PERIODIC MAINTENANCE AND ADJUSTMENT

And do not touch the radiator pipe after high-speed operation, otherwise the cooling system is hot and cause burns. Always let the engine oil cool down sufficiently before removing the oil tank cap. **NOTICE:** Do not operate the vehicle until you know that the engine oil level is sufficient.

TIP

The engine oil should be above the minimum level mark.

6

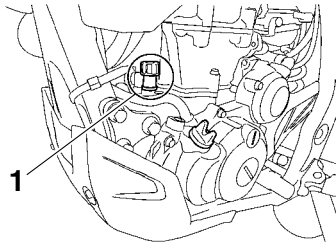

1. Engine oil tank cap

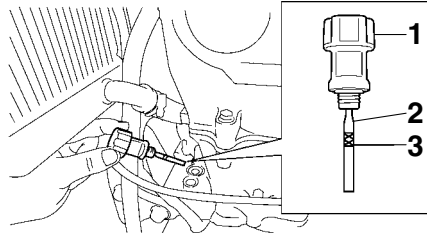

1. Engine oil tank cap
2. Dipstick
3. Minimum level mark
4. Remove the engine oil check bolt and its gasket, and then check the engine oil level.

TIP

The engine oil should be below the brim of the check bolt hole.

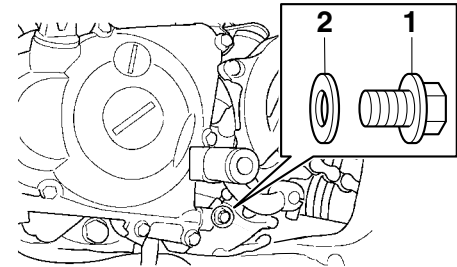

1. Engine oil check bolt
2. Gasket
5. If the engine oil is below the minimum level mark, add sufficient oil of the recommended type to raise it to the brim of the engine oil check bolt hole.

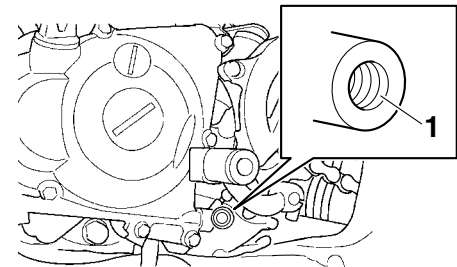

1. Engine oil check bolt hole

PERIODIC MAINTENANCE AND ADJUSTMENT

6. Install the engine oil tank cap, and then the check bolt and its gasket.

To change the engine oil (with or without oil filter element replacement)

1. Place the vehicle on a level surface.
2. Start the engine, warm it up for several minutes, and then turn it off.
3. Place an oil pan under the engine to collect the used oil.
4. Remove the engine guard by removing the bolts.

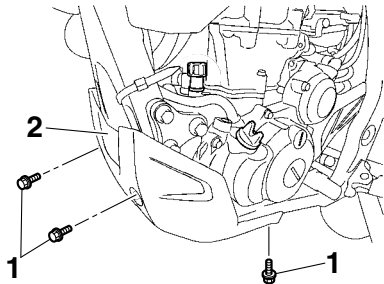

1. Bolt
2. Engine guard

5. Remove the engine oil tank cap

and the engine oil filler cap.

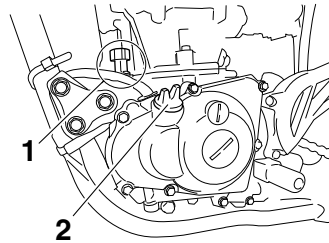

1. Engine oil tank cap
2. Engine oil filler cap

6. Remove the engine oil drain bolts and their gasket to drain the oil from the oil tank and crankcase.

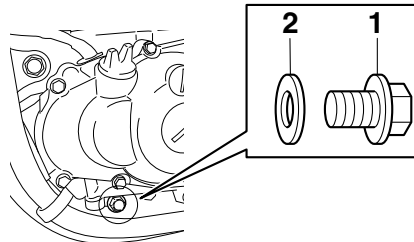

1. Engine oil drain bolt (oil tank)
2. Gasket

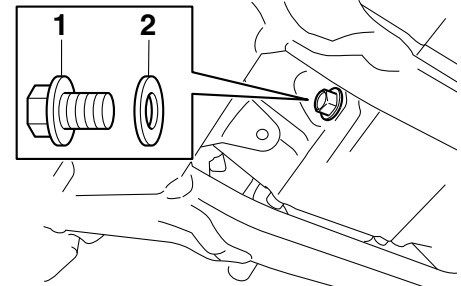

1. Engine oil drain bolt (crankcase)
2. Gasket

7. Remove the engine oil filter element drain bolt and gasket to drain the oil from the oil filter element.

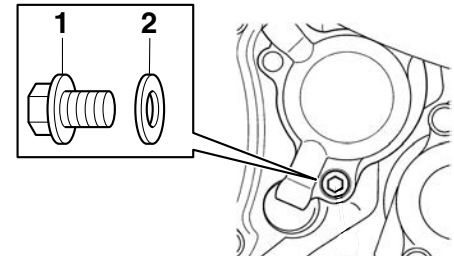

1. Engine oil filter element drain bolt
2. Gasket

PERIODIC MAINTENANCE AND ADJUSTMENT

TIP
Skip steps 8–10 if the oil filter element is not being replaced.

8. Remove the oil filter element cover by removing the bolts.

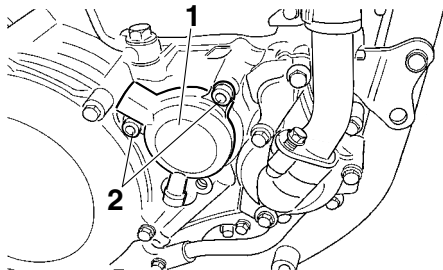

1. Oil filter element cover
2. Oil filter element cover bolt

9. Remove and replace the oil filter element and O-rings.

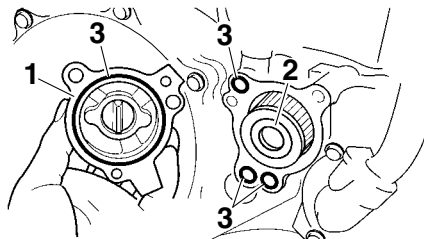

1. Oil filter element cover
2. Oil filter element
3. O-ring

10. Install the oil filter element cover by installing the bolts, and then tighten the bolts to the specified torque.

Tightening torque:

Oil filter element cover bolt:
10 Nm (1.0 m·kgf, 7.2 ft·lbf)

TIP
Make sure that the O-rings are properly seated.

11. Install the engine oil drain bolts and their new gasket, and then tighten the bolts to the specified torques.

Tightening torques:

Engine oil drain bolt (oil tank):
20 Nm (2.0 m·kgf, 14 ft·lbf)
Engine oil drain bolt (crank case):
20 Nm (2.0 m·kgf, 14 ft·lbf)
Engine oil filter element drain bolt:
10 Nm (1.0 m·kgf, 7.2 ft·lbf)

12. Refill with the specified amount of the recommended engine oil, and then install and tighten the engine oil tank cap and the oil filler cap.

Recommended engine oil:

See page 8-1.

Oil quantity:

Without oil filter element replacement:
0.95 L (1.00 US qt, 0.84 Imp. qt)
With oil filter element replacement:
1.00 L (1.06 US qt, 0.88 Imp. qt)

TIP
Be sure to wipe off spilled oil on any parts after the engine and exhaust system have cooled down.

NOTICE

- In order to prevent clutch slippage (since the engine oil also lubricates the clutch), do not

ECA11620

PERIODIC MAINTENANCE AND ADJUSTMENT

EAU20070

mix any chemical additives. Do not use oils with a diesel specification of “CD” or oils of a higher quality than specified. In addition, do not use oils labeled “ENERGY CONSERVING II” or higher.

- Make sure that no foreign material enters the crankcase.

13. Start the engine, and then let it idle for several minutes while checking it for oil leakage. If oil is leaking, immediately turn the engine off and check for the cause.
14. Turn the engine off, wait a few minutes until the oil settles, and then check the oil level and correct it if necessary.
15. Install the engine guard by installing the bolts.

Tightening torque:

Engine guard bolt:
7 Nm (0.7 m·kgf, 5.1 ft·lbf)

ECA11231

NOTICE

After changing the engine oil, make sure to check the oil pressure as de-

scribed below.

- Loosen the bleed bolt.
- Start the engine and keep it idling until oil flows out. If no oil comes out after one minute, turn the engine off immediately so it will not seize. If this occurs, have a Yamaha dealer repair the vehicle.
- After checking the oil pressure, tighten the bleed bolt to the specified torque.

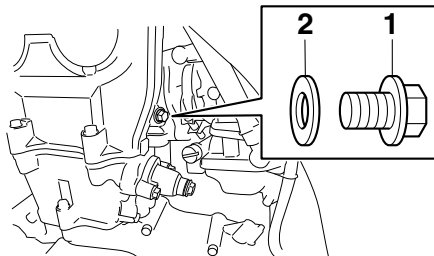

1. Bleed bolt
2. Gasket

Tightening torque:

Bleed bolt:
10 Nm (1.0 m·kgf, 7.2 ft·lbf)

Coolant

The coolant level should be checked before each ride. In addition, the coolant must be changed at the intervals specified in the periodic maintenance and lubrication chart.

EAM1295

To check the coolant level

1. Place the vehicle on a level surface and hold it in an upright position.

TIP

- The coolant level must be checked on a cold engine since the level varies with engine temperature.
- Make sure that the vehicle is positioned straight up when checking the coolant level. A slight tilt to the side can result in a false reading.

2. Remove the radiator cap and check the coolant level in the radiator. **WARNING! Never attempt to remove the radiator cap when the engine is hot.**^[EWA10381]

PERIODIC MAINTENANCE AND ADJUSTMENT

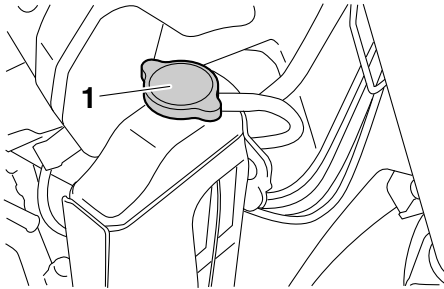

1. Radiator cap

TIP

The coolant should be at the bottom of the radiator filler neck. The level will change with variation of engine temperature.

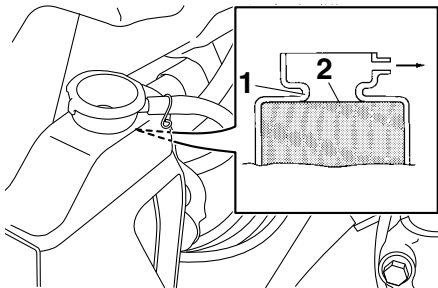

1. Radiator filler neck
2. Correct coolant level

3. If the coolant is below the correct coolant level, add coolant, and then install the radiator cap. **NOTICE:** If coolant is not available, use distilled water or soft tap water instead. Do not use hard water or salt water since it is harmful to the engine. If water has been used instead of coolant, replace it with coolant as soon as possible, otherwise the cooling system will not be protected against frost and corrosion. If water has been added to the coolant, have a Yamaha dealer check the antifreeze content of the coolant as soon as possible, otherwise the effectiveness of the coolant will be reduced.^[ECA10472]

To change the coolant

1. Place the vehicle on a level surface and let the engine cool if necessary.
2. Place a container under the engine to collect the used coolant.
3. Remove the coolant drain bolt and

its gasket, and then the radiator cap to drain the cooling system. **WARNING!** Never attempt to remove the radiator cap when the engine is hot.^[EWA10381]

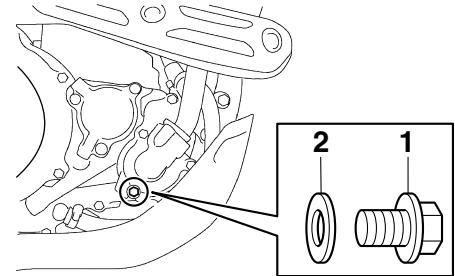

1. Coolant drain bolt
2. Gasket

4. After the coolant is completely drained, thoroughly flush the cooling system with clean tap water.
5. Install the coolant drain bolt and its new gasket, and then tighten the bolt to the specified torque.

Tightening torque:

Coolant drain bolt:
10 Nm (1.0 m·kgf, 7.2 ft·lbf)

6. Pour the recommended coolant

EAUM1315

PERIODIC MAINTENANCE AND ADJUSTMENT

into the radiator until it is full.

Antifreeze/water mixture ratio:

1:1

Recommended antifreeze:

High-quality ethylene glycol anti-freeze containing corrosion inhibitors for aluminum engines

Coolant quantity:

Radiator capacity (including all routes):

1.04 L (1.10 US qt, 0.92 Imp.qt)

7. Install the radiator cap, start the engine, let it idle for several minutes, and then turn it off.
8. Remove the radiator cap to check the coolant level in the radiator. If necessary, add sufficient coolant until it reaches the bottom of the radiator filler neck, and then install the radiator cap.
9. Start the engine, and then check the vehicle for coolant leakage. If coolant is leaking, have a Yamaha dealer check the cooling system.

Cleaning the air filter element and check hose

EAU52932

The air filter element should be cleaned or replaced at the intervals specified in the periodic maintenance and lubrication chart. Clean or, if necessary, replace the air filter element more frequently if you are riding in unusually wet or dusty areas. In addition, the air filter check hose must be frequently checked and cleaned if necessary.

To clean the air filter element

1. Open the air filter case cover by loosening the quick fastener screw and pulling the case cover outward as shown.

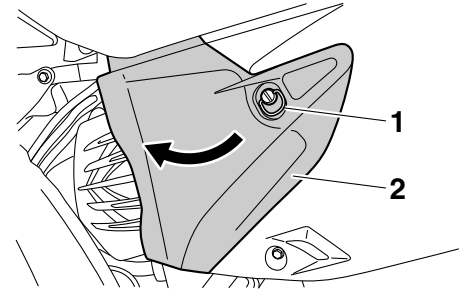

1. Quick fastener screw
2. Air filter case cover

2. Unhook the holding clip, and then pull the air filter element out.

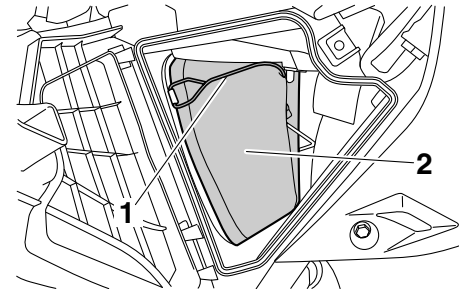

1. Holding clip
2. Air filter element

3. Remove the sponge material from the air filter element frame, clean it

PERIODIC MAINTENANCE AND ADJUSTMENT

with solvent, and then squeeze the remaining solvent out. **WARNING!** Use only a dedicated parts cleaning solvent. To avoid the risk of fire or explosion, do not use gasoline or solvents with a low flash point.^[EWA10431] **NOTICE:** To avoid damaging the foam material, handle it gently and carefully, and do not twist or wring it.^[ECA10511]

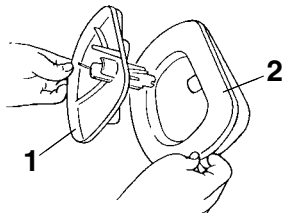

1. Air filter element frame
2. Sponge material

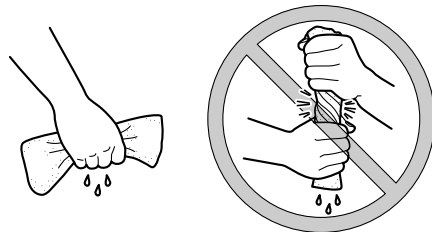

4. Apply oil of the recommended type to the entire surface of the sponge material, and then squeeze the excess oil out.

TIP

The sponge material should be wet but not dripping.

Recommended oil:

Yamaha foam air filter oil or other quality foam air filter oil

5. Pull the sponge material over the air filter element frame.

TIP

- Align the projection on the air filter element frame with the hole in the sponge material.
- Apply the lithium soap base

grease on the matching surface on the sponge material.

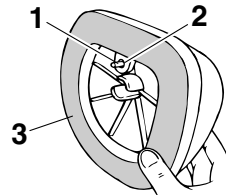

1. Projection
2. Hole
3. Matching surface

6. Insert the air filter element into the air filter case. **NOTICE: Make sure that the air filter element is properly seated in the air filter case. The engine should never be operated without the air filter element installed, otherwise the piston(s) and/or cylinder(s) may become excessively worn.**^[ECA10481]

TIP

Align the projection on the air filter element with the hole in the air filter case.

PERIODIC MAINTENANCE AND ADJUSTMENT

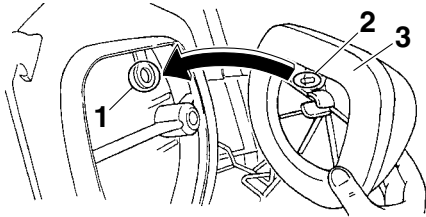

1. Hole
2. Projection
3. Air filter element

7. Place the holding clip in the original position.

TIP

Hook the holding clip so that it contacts the filter guide projections.

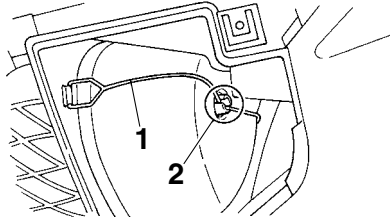

1. Holding clip
 2. Projection
8. Close the air filter case cover, and then tighten the quick fastener screw.

To clean the air filter check hose

1. Check the hose at the bottom of the air filter case for accumulated dirt or water.

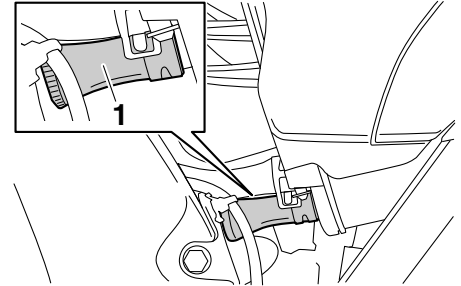

1. Air filter check hose
2. If dirt or water is visible, remove the hose, clean it, and then install it.

PERIODIC MAINTENANCE AND ADJUSTMENT

EAU52460

Adjusting the engine idling speed

The engine idling speed must be checked and, if necessary, adjusted as follows.

TIP

A digital tachometer is needed to make this adjustment.

1. Position the digital tachometer at the ignition coil, which is located in the spark plug cap.
2. Check the engine idling speed and, if necessary, adjust it to specification by turning the starter knob/idle adjusting screw. To increase the engine idling speed, turn the screw in direction (a). To decrease the engine idling speed, turn the screw in direction (b).

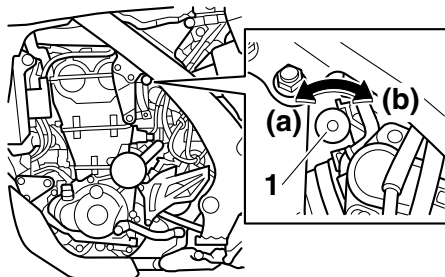

1. Starter knob/idle adjusting screw

Engine idling speed:
1900–2100 r/min

TIP

If the specified idling speed cannot be obtained as described above, have a Yamaha dealer make the adjustment.

EAU21384

Checking the throttle grip free play

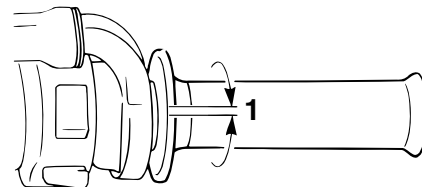

1. Throttle grip free play

The throttle grip free play should measure 3.0–5.0 mm (0.12–0.20 in) at the inner edge of the throttle grip. Periodically check the throttle grip free play and, if necessary, have a Yamaha dealer adjust it.

PERIODIC MAINTENANCE AND ADJUSTMENT

EAU21401

Valve clearance

The valve clearance changes with use, resulting in improper air-fuel mixture and/or engine noise. To prevent this from occurring, the valve clearance must be adjusted by a Yamaha dealer at the intervals specified in the periodic maintenance and lubrication chart.

EAU52881

Tires

Tires are the only contact between the vehicle and the road. Safety in all conditions of riding depends on a relatively small area of road contact. Therefore, it is essential to maintain the tires in good condition at all times and replace them at the appropriate time with the specified tires.

Tire air pressure

The tire air pressure should be checked and, if necessary, adjusted before each ride.

EWA10441

WARNING

Operation of this vehicle with improper tire pressure may cause severe injury or death from loss of control.

- The tire air pressure must be checked and adjusted on cold tires (i.e., when the temperature of the tires equals the ambient temperature).
- The tire air pressure must be adjusted in accordance with the riding speed and with the total

weight of rider, cargo, and accessories approved for this model.

Tire air pressure (measured on cold tires):

0–90 kg (0–198 lb):

Front:

150 kPa (1.50 kgf/cm², 22 psi)

Rear:

200 kPa (2.00 kgf/cm², 29 psi)

Maximum load*:

90 kg (198 lb)

* Total weight of rider, cargo and accessories

EWA10511

WARNING

Never overload your vehicle. Operation of an overloaded vehicle could cause an accident.

6

PERIODIC MAINTENANCE AND ADJUSTMENT

Tire inspection

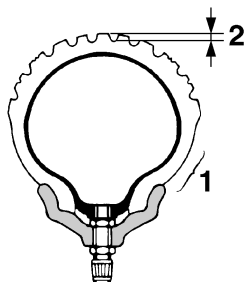

1. Tire sidewall
2. Tire tread depth

The tires must be checked before each ride. If the center tread depth reaches the specified limit, if the tire has a nail or glass fragments in it, or if the sidewall is cracked, have a Yamaha dealer replace the tire immediately.

Minimum tire tread depth (front and rear):

1.6 mm (0.06 in)

TIP

The tire tread depth limits may differ from country to country. Always comply with the local regulations.

Tire information

This motorcycle is equipped with spoke wheels and tube tires.

Tires age, even if they have not been used or have only been used occasionally. Cracking of the tread and sidewall rubber, sometimes accompanied by carcass deformation, is an evidence of ageing. Old and aged tires shall be checked by tire specialists to ascertain their suitability for further use.

EWA10461



The front and rear tires should be of the same make and design, otherwise the handling characteristics of the vehicle may be different, which could lead to an accident.

After extensive tests, only the tires listed below have been approved for this model by Yamaha Motor Co., Ltd.

Front tire:

Size:

80/100-21M/C 51P

Manufacturer/model:

BRIDGESTONE/GRITTY-ED03 E

Rear tire:

Size:

120/90-18M/C 65P

Manufacturer/model:

BRIDGESTONE/GRITTY-ED04 E

EWA10571

WARNING

- Have a Yamaha dealer replace excessively worn tires. Besides being illegal, operating the motorcycle with excessively worn tires decreases riding stability and can lead to loss of control.
- The replacement of all wheel- and brake-related parts, including the tires, should be left to a Yamaha dealer, who has the necessary professional knowledge and experience.
- It is not recommended to patch a punctured tube. If unavoidable, however, patch the tube very carefully and replace it as soon as possible with a

PERIODIC MAINTENANCE AND ADJUSTMENT

high-quality product.

- Ride at moderate speeds after changing a tire since the tire surface must first be “broken in” for it to develop its optimal characteristics.

Spoke wheels

EAU21943

EWA10610

⚠ WARNING

The wheels on this model are not designed for use with tubeless tires. Do not attempt to use tubeless tires on this model.

To maximize the performance, durability, and safe operation of your motorcycle, note the following points regarding the specified wheels.

- The wheel rims should be checked for cracks, bends, warpage or other damage, and the spokes for looseness or damage before each ride. If any damage is found, have a Yamaha dealer replace the wheel. Do not attempt even the smallest repair to the wheel. A deformed or cracked wheel must be replaced.
- The wheel should be balanced whenever either the tire or wheel has been changed or replaced. An unbalanced wheel can result in poor performance, adverse handling characteristics, and a shortened tire life.

EAU52911

Adjusting the clutch lever free play

The clutch lever free play should measure 8.0–13.0 mm (0.31–0.51 in) as shown. Periodically check the clutch lever free play and, if necessary, adjust it as follows.

1. To increase the clutch lever free play, turn the clutch lever free play adjusting bolt in direction (a). To decrease the clutch lever free play, turn the adjusting bolt in direction (b).

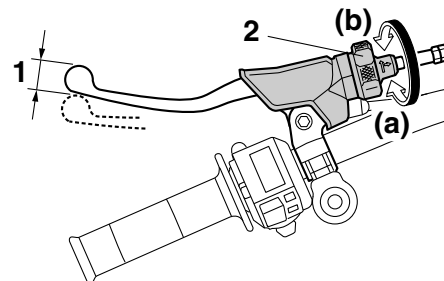

1. Clutch lever free play
2. Clutch lever free play adjusting bolt

TIP

If the specified clutch lever free play

PERIODIC MAINTENANCE AND ADJUSTMENT

could be obtained as described above, skip steps 2–5.

2. Fully turn the adjusting bolt in direction (a) to loosen the clutch cable.
3. Slide the rubber cover back further down the clutch cable, and then loosen the locknut.
4. To increase the clutch lever free play, turn the clutch lever free play adjusting nut in direction (a). To decrease the clutch lever free play, turn the adjusting nut in direction (b).

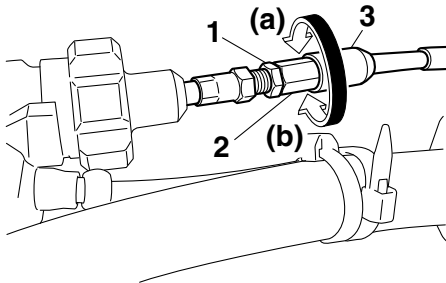

1. Locknut
2. Clutch lever free play adjusting nut (clutch cable)
3. Rubber cover

5. Tighten the locknut at the clutch cable, and then slide the rubber cover to its original position.

Checking the brake lever free play

EAU37913

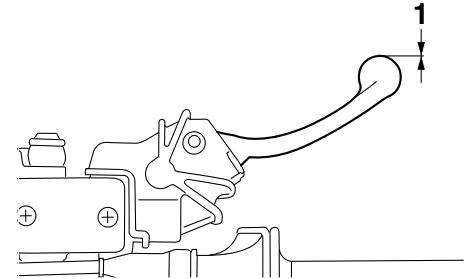

1. No brake lever free play

There should be no free play at the brake lever end. If there is free play, have a Yamaha dealer inspect the brake system.

EWA14211

⚠ WARNING

A soft or spongy feeling in the brake lever can indicate the presence of air in the hydraulic system. If there is air in the hydraulic system, have a Yamaha dealer bleed the system before operating the vehicle. Air in the hydraulic system will diminish the braking performance, which may re-

PERIODIC MAINTENANCE AND ADJUSTMENT

sult in loss of control and an accident.

Checking the shift pedal

The operation of the shift pedal should be checked before each ride. If operation is not smooth, have a Yamaha dealer check the vehicle.

EAU44820

Brake light switches

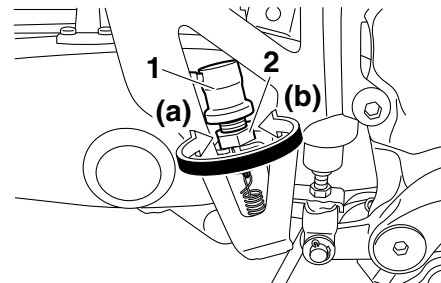

EAU22273

1. Rear brake light switch
2. Rear brake light switch adjusting nut

The brake light, which is activated by the brake pedal and brake lever, should come on just before braking takes effect. If necessary, adjust the rear brake light switch as follows, but the front brake light switch should be adjusted by a Yamaha dealer.

Turn the rear brake light switch adjusting nut while holding the rear brake light switch in place. To make the brake light come on earlier, turn the adjusting nut in direction (a). To make the brake light come on later, turn the adjusting nut in direction (b).

PERIODIC MAINTENANCE AND ADJUSTMENT

Checking the front and rear brake pads

EAU22392

The front and rear brake pads must be checked for wear at the intervals specified in the periodic maintenance and lubrication chart.

Front brake pads

EAU22430

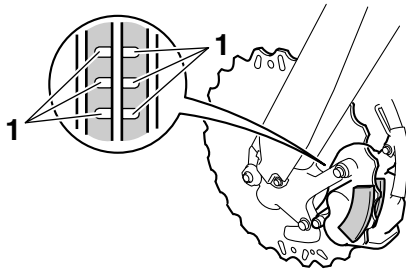

1. Brake pad wear indicator groove

Each front brake pad is provided with wear indicator grooves, which allow you to check the brake pad wear without having to disassemble the brake. To check the brake pad wear, check the wear indicator grooves. If a brake pad has worn to the point that the wear indicator grooves have almost disap-

peared, have a Yamaha dealer replace the brake pads as a set.

Rear brake pads

EAU48070

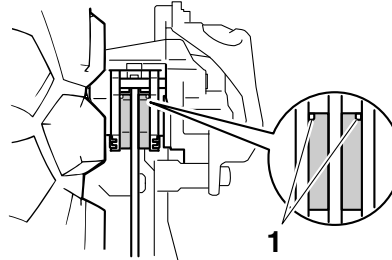

1. Brake pad wear indicator groove

Each rear brake pad is provided with a wear indicator groove, which allows you to check the brake pad wear without having to disassemble the brake. To check the brake pad wear, check the wear indicator groove. If a brake pad has worn to the point that the wear indicator groove almost appears, have a Yamaha dealer replace the brake pads as a set.

Checking the brake fluid level

EAU22581

Before riding, check that the brake fluid is above the minimum level mark. Check the brake fluid level with the top of the reservoir level. Replenish the brake fluid if necessary.

Front brake

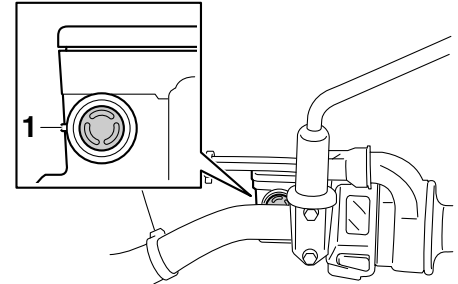

1. Minimum level mark

PERIODIC MAINTENANCE AND ADJUSTMENT

EAU52952

Rear brake

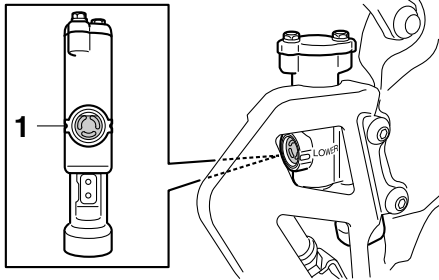

1. Minimum level mark

Specified brake fluid:
DOT 4

EWA15990

WARNING

Improper maintenance can result in loss of braking ability. Observe these precautions:

- Insufficient brake fluid may allow air to enter the brake system, reducing braking performance.
- Clean the filler cap before removing. Use only DOT 4 brake fluid from a sealed container.
- Use only the specified brake fluid; otherwise, the rubber seals

may deteriorate, causing leakage.

- Refill with the same type of brake fluid. Adding a brake fluid other than DOT 4 may result in a harmful chemical reaction.
- Be careful that water does not enter the brake fluid reservoir when refilling. Water will significantly lower the boiling point of the fluid and may result in vapor lock.

ECA17640

NOTICE

Brake fluid may damage painted surfaces or plastic parts. Always clean up spilled fluid immediately.

As the brake pads wear, it is normal for the brake fluid level to gradually go down. A low brake fluid level may indicate worn brake pads and/or brake system leakage; therefore, be sure to check the brake pads for wear and the brake system for leakage. If the brake fluid level goes down suddenly, have a Yamaha dealer check the cause before further riding.

Changing the brake fluid

Have a Yamaha dealer change the brake fluid at the intervals specified in the periodic maintenance and lubrication chart. In addition, have the oil seals of the master cylinders and calipers as well as the brake hoses replaced every 20000 km (12000 mi) or every two years or whenever they are damaged or leaking.

PERIODIC MAINTENANCE AND ADJUSTMENT

Drive chain slack

The drive chain slack should be checked before each ride and adjusted if necessary.

EAU22760

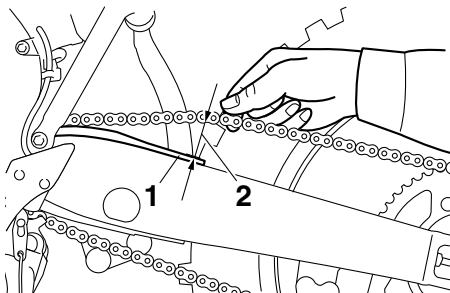

To check the drive chain slack

EAU52480

1. Place the motorcycle on the side-stand.

TIP

When checking and adjusting the drive chain slack, there should be no weight on the motorcycle.

2. Shift the transmission into the neutral position.
3. Pull the drive chain up above the drive chain guard installation bolt with a force of 50 N (5.0 kgf, 11 lbf).
4. Measure drive chain slack between the drive chain guard and the bottom of the chain as shown.

Drive chain slack:

48.0–58.0 mm (1.89–2.28 in)

1. Drive chain guard
2. Drive chain slack
5. If the drive chain slack is incorrect, adjust it as follows.

To adjust the drive chain slack

EAU34317

Consult a Yamaha dealer before adjusting the drive chain slack.

1. Loosen the axle nut and the locknut on each side of the swingarm.
2. To tighten the drive chain, turn the drive chain slack adjusting bolt on each side of the swingarm in direction (a). To loosen the drive chain, turn the adjusting bolt on each side of the swingarm in direction (b), and then push the rear wheel forward. **NOTICE: Improper drive**

chain slack will overload the engine as well as other vital parts of the motorcycle and can lead to chain slippage or breakage. To prevent this from occurring, keep the drive chain slack within the specified limits. [ECA10571]

TIP

Using the alignment marks on each side of the swingarm, make sure that both drive chain pullers are in the same position for proper wheel alignment.

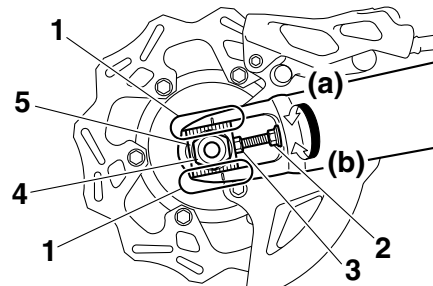

1. Alignment marks
2. Locknut
3. Drive chain slack adjusting bolt
4. Axle nut
5. Drive chain puller
3. Tighten the axle nut, then the lock-

PERIODIC MAINTENANCE AND ADJUSTMENT

nuts to their specified torques.

Tightening torques:

Axle nut:

125 Nm (12.5 m·kgf, 90 ft·lbf)

Locknut:

19 Nm (1.9 m·kgf, 14 ft·lbf)

4. Make sure that the drive chain pullers are in the same position, the drive chain slack is correct, and the drive chain moves smoothly.

EAU23025

Cleaning and lubricating the drive chain

The drive chain must be cleaned and lubricated at the intervals specified in the periodic maintenance and lubrication chart, otherwise it will quickly wear out, especially when riding in dusty or wet areas. Service the drive chain as follows.

ECA10583

NOTICE

The drive chain must be lubricated after washing the motorcycle, riding in the rain or riding in wet areas.

1. Clean the drive chain with kerosene and a small soft brush.
NOTICE: To prevent damaging the O-rings, do not clean the drive chain with steam cleaners, high-pressure washers or inappropriate solvents.^[ECA11121]
2. Wipe the drive chain dry.
3. Thoroughly lubricate the drive chain with a special O-ring chain lubricant. **NOTICE: Do not use engine oil or any other lubricants for the drive chain, as they**

may contain substances that could damage the O-rings.^[ECA11111]

PERIODIC MAINTENANCE AND ADJUSTMENT

EAU23096

Checking and lubricating the cables

The operation of all control cables and the condition of the cables should be checked before each ride, and the cables and cable ends should be lubricated if necessary. If a cable is damaged or does not move smoothly, have a Yamaha dealer check or replace it. **WARNING! Damage to the outer housing of cables may result in internal rusting and cause interference with cable movement. Replace damaged cables as soon as possible to prevent unsafe conditions.**[EWA10711]

Recommended lubricant:

Yamaha cable lubricant or other suitable cable lubricant

EAU23114

Checking and lubricating the throttle grip and cable

The operation of the throttle grip should be checked before each ride. In addition, the cable should be lubricated by a Yamaha dealer at the intervals specified in the periodic maintenance chart. The throttle cable is equipped with a rubber cover. Make sure that the cover is securely installed. Even though the cover is installed correctly, it does not completely protect the cable from water entry. Therefore, use care not to pour water directly onto the cover or cable when washing the vehicle. If the cable or cover becomes dirty, wipe clean with a moist cloth.

EAU23143

Checking and lubricating the brake and clutch levers

The operation of the brake and clutch levers should be checked before each ride, and the lever pivots should be lubricated if necessary.

Brake lever

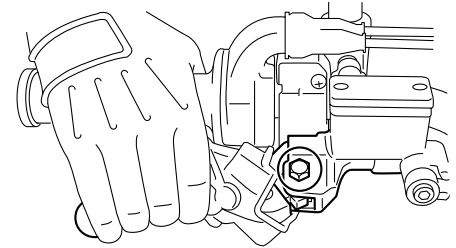

PERIODIC MAINTENANCE AND ADJUSTMENT

Clutch lever

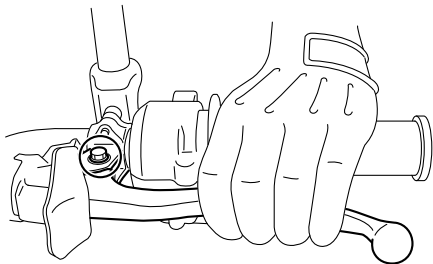

Recommended lubricants:

- Brake lever:
Silicone grease
- Clutch lever:
Lithium-soap-based grease

EAU23183

Checking and lubricating the brake pedal

The operation of the brake pedal should be checked before each ride, and the pedal pivot should be lubricated if necessary.

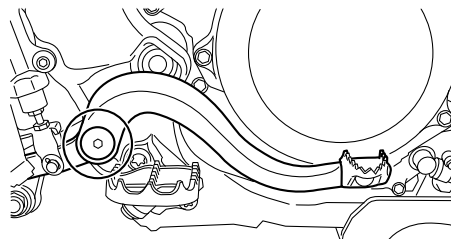

Recommended lubricant:
Lithium-soap-based grease

EAU23202

Checking and lubricating the sidestand

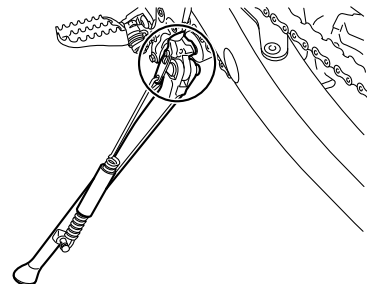

The operation of the sidestand should be checked before each ride, and the sidestand pivot and metal-to-metal contact surfaces should be lubricated if necessary.

EWA10731

⚠ WARNING

If the sidestand does not move up and down smoothly, have a Yamaha dealer check or repair it. Otherwise, the sidestand could contact the ground and distract the operator, resulting in a possible loss of control.

Recommended lubricant:
Lithium-soap-based grease

PERIODIC MAINTENANCE AND ADJUSTMENT

EAUM1652

Lubricating the swingarm pivots

The swingarm pivots must be lubricated by a Yamaha dealer at the intervals specified in the periodic maintenance and lubrication chart.

Recommended lubricant:
Lithium-soap-based grease

EAU23272

Checking the front fork

The condition and operation of the front fork must be checked as follows at the intervals specified in the periodic maintenance and lubrication chart.

To check the condition

Check the inner tubes for scratches, damage and excessive oil leakage.

To check the operation

1. Place the vehicle on a level surface and hold it in an upright position. **WARNING! To avoid injury, securely support the vehicle so there is no danger of it falling over.**^[EWA10751]
2. While applying the front brake, push down hard on the handlebars several times to check if the front fork compresses and rebounds smoothly.

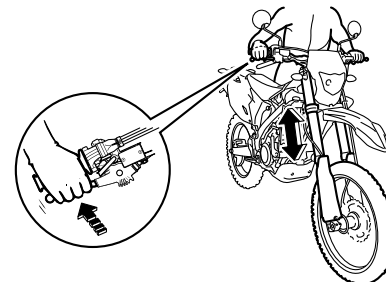

ECA10590

NOTICE

If any damage is found or the front fork does not operate smoothly, have a Yamaha dealer check or repair it.

PERIODIC MAINTENANCE AND ADJUSTMENT

EAU23283

Checking the steering

Worn or loose steering bearings may cause danger. Therefore, the operation of the steering must be checked as follows at the intervals specified in the periodic maintenance and lubrication chart.

1. Place a stand under the engine to raise the front wheel off the ground. (See page 6-36 for more information.) **WARNING! To avoid injury, securely support the vehicle so there is no danger of it falling over.** [EWA10751]
2. Hold the lower ends of the front fork legs and try to move them forward and backward. If any free play can be felt, have a Yamaha dealer check or repair the steering.

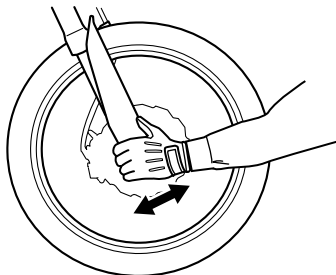

EAU23291

Checking the wheel bearings

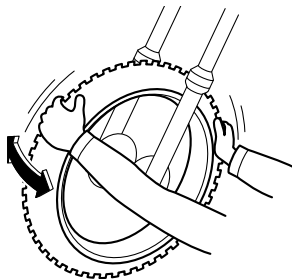

The front and rear wheel bearings must be checked at the intervals specified in the periodic maintenance and lubrication chart. If there is play in the wheel hub or if the wheel does not turn smoothly, have a Yamaha dealer check the wheel bearings.

EAU52491

Battery

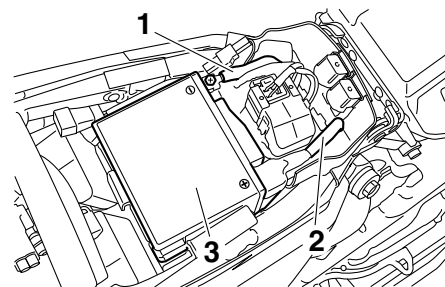

1. Negative battery lead (black)
2. Positive battery lead (red)
3. Battery

The battery is located under the seat. (See page 3-13.)

This model is equipped with a VRLA (Valve Regulated Lead Acid) battery. There is no need to check the electrolyte or to add distilled water. However, the battery lead connections need to be checked and, if necessary, tightened.

EWA10760

WARNING

- **Electrolyte is poisonous and dangerous since it contains sulfuric acid, which causes severe burns. Avoid any contact with**

PERIODIC MAINTENANCE AND ADJUSTMENT

skin, eyes or clothing and always shield your eyes when working near batteries. In case of contact, administer the following FIRST AID.

- **EXTERNAL:** Flush with plenty of water.
 - **INTERNAL:** Drink large quantities of water or milk and immediately call a physician.
 - **EYES:** Flush with water for 15 minutes and seek prompt medical attention.
 - Batteries produce explosive hydrogen gas. Therefore, keep sparks, flames, cigarettes, etc., away from the battery and provide sufficient ventilation when charging it in an enclosed space.
 - **KEEP THIS AND ALL BATTERIES OUT OF THE REACH OF CHILDREN.**
-

To charge the battery

Have a Yamaha dealer charge the battery as soon as possible if it seems to have discharged. Keep in mind that the

battery tends to discharge more quickly if the vehicle is equipped with optional electrical accessories.

ECA16521

NOTICE

To charge a VRLA (Valve Regulated Lead Acid) battery, a special (constant-voltage) battery charger is required. Using a conventional battery charger will damage the battery.

To store the battery

1. If the vehicle will not be used for more than one month, remove the battery, fully charge it, and then place it in a cool, dry place. **NOTICE:** When removing the battery, be sure the main switch is pushed to “OFF”, then disconnect the negative lead before disconnecting the positive lead.^[ECA17810]
2. If the battery will be stored for more than two months, check it at least once a month and fully charge it if necessary.
3. Fully charge the battery before installation. **NOTICE:** When install-

ing the battery, be sure the main switch is pushed to “OFF”, then connect the positive lead before connecting the negative lead.^[ECA17770]

4. After installation, make sure that the battery leads are properly connected to the battery terminals.

ECA16530

NOTICE

Always keep the battery charged. Storing a discharged battery can cause permanent battery damage.

PERIODIC MAINTENANCE AND ADJUSTMENT

Replacing the fuse

EAU52422

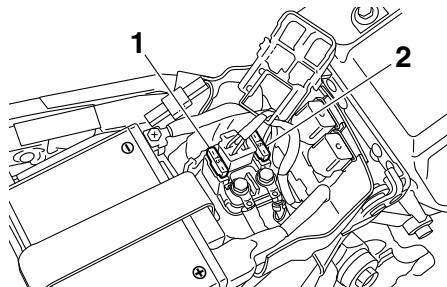

1. Fuse
2. Spare fuse

The fuse is located under the seat.
(See page 3-13.)

If the fuse is blown, replace it as follows.

1. Push the main switch to “OFF” and turn off all electrical circuits.
2. Remove the blown fuse, and then install a new fuse of the specified amperage. **WARNING! Do not use a fuse of a higher amperage rating than recommended to avoid causing extensive damage to the electrical system and possibly a fire.**^[EWA15131]

Specified fuse:
15.0 A

3. Push the main switch to “ON” and turn on the electrical circuits to check if the devices operate.
4. If the fuse immediately blows again, have a Yamaha dealer check the electrical system.

EAU53220

Replacing the headlight bulb

This model is equipped with a halogen bulb headlight. If the headlight bulb burns out, replace it as follows.

ECA10650

NOTICE

Take care not to damage the following parts:

- **Headlight bulb**
Do not touch the glass part of the headlight bulb to keep it free from oil, otherwise the transparency of the glass, the luminosity of the bulb, and the bulb life will be adversely affected. Thoroughly clean off any dirt and fingerprints on the headlight bulb using a cloth moistened with alcohol or thinner.
- **Headlight lens**
Do not affix any type of tinted film or stickers to the headlight lens.
Do not use a headlight bulb of a wattage higher than specified.

PERIODIC MAINTENANCE AND ADJUSTMENT

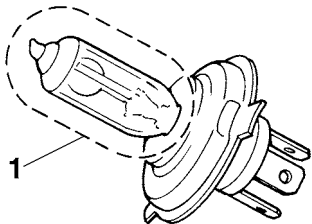

1. Do not touch the glass part of the bulb.

1. Remove the headlight cowling together with the headlight unit by removing the bolts and pulling upward as shown.

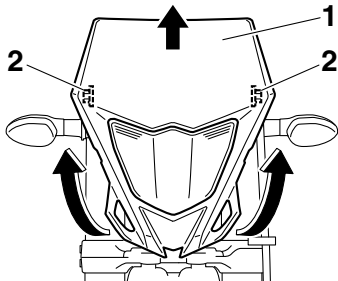

1. Headlight cowling
2. Bolt

2. Disconnect the headlight coupler,

and then remove the headlight bulb cover.

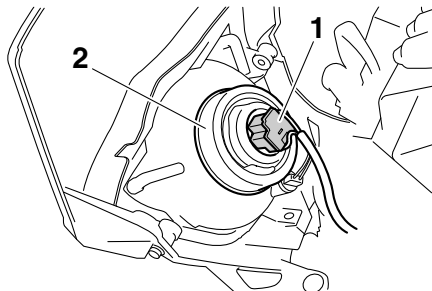

1. Headlight coupler
2. Headlight bulb cover

3. Remove the headlight bulb holder by turning it counterclockwise, and then remove the burnt-out bulb.

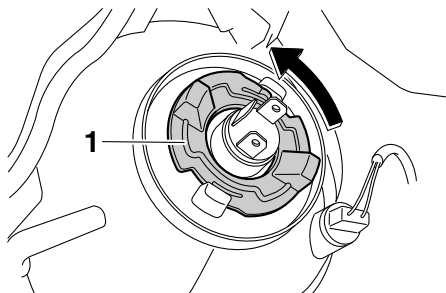

1. Headlight bulb holder

4. Place a new headlight bulb into position, and then secure it with the bulb holder.
5. Install the bulb cover, and then connect the coupler.
6. Install the headlight cowling (together with the headlight unit) by placing it in the original position, and then installing the bolts.
7. Have a Yamaha dealer adjust the headlight beam if necessary.

PERIODIC MAINTENANCE AND ADJUSTMENT

Tail/brake light

This model is equipped with an LED-type tail/brake light.

If the tail/brake light does not come on, have a Yamaha dealer check it.

EAU24181

Replacing a turn signal light bulb

EAU24204

1. Remove the turn signal light lens by removing the screw.

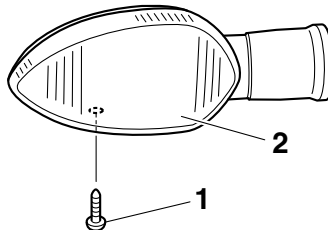

1. Screw
2. Turn signal light lens

2. Remove the burnt-out bulb by pushing it in and turning it counter-clockwise.

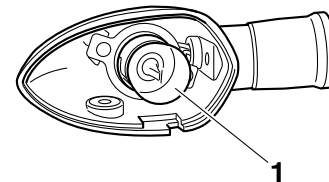

1. Turn signal light bulb
3. Insert a new bulb into the socket, push it in, and then turn it clockwise until it stops.
4. Install the lens by installing the screw. **NOTICE: Do not over-tighten the screw, otherwise the lens may break.**^[ECA11191]

PERIODIC MAINTENANCE AND ADJUSTMENT

EAU24313

Replacing the license plate light bulb

1. Remove the license plate light unit by removing the screws.

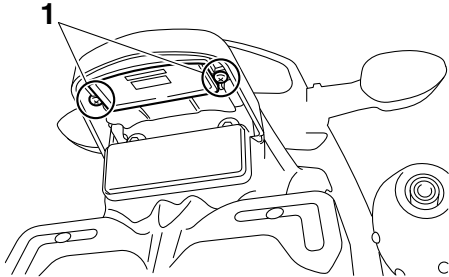

1. Screw
2. Remove the license plate light bulb socket (together with the bulb) by pulling it out.

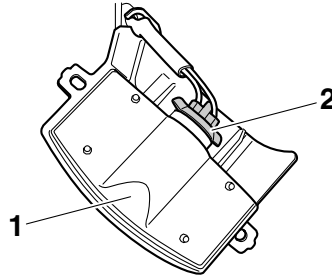

1. License plate light unit
2. License plate light bulb socket
3. Remove the burnt-out bulb by pulling it out.
4. Insert a new bulb into the socket.
5. Install the socket (together with the bulb) by pushing it in.
6. Install the license plate light unit by installing the screws.

EAU45224

Replacing an auxiliary light bulb

If the auxiliary light bulb burns out, replace it as follows.

1. Remove the headlight unit. (See page 6-32.)
2. Remove the auxiliary light bulb socket (together with the bulb) by pulling it out.

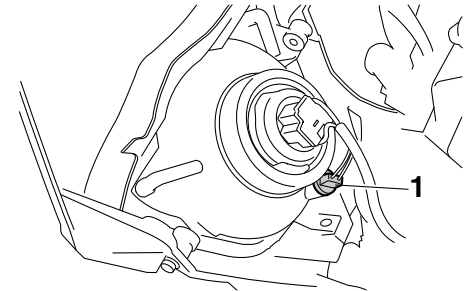

1. Auxiliary light bulb socket
3. Remove the burnt-out bulb by pulling it out.

PERIODIC MAINTENANCE AND ADJUSTMENT

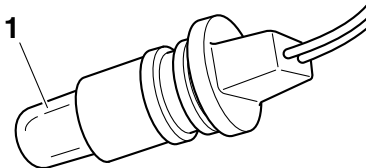

EAU24350

frame in front of the rear wheel or under each side of the swingarm.

Supporting the motorcycle

Since this model is not equipped with a centerstand, follow these precautions when removing the front and rear wheel or performing other maintenance requiring the motorcycle to stand upright. Check that the motorcycle is in a stable and level position before starting any maintenance. A strong wooden box can be placed under the engine for added stability.

1. Auxiliary light bulb

4. Insert a new bulb into the socket.
5. Install the socket (together with the bulb) by pushing it in.
6. Install the headlight unit.

To service the front wheel

1. Stabilize the rear of the motorcycle by using a motorcycle stand or, if an additional motorcycle stand is not available, by placing a jack under the frame in front of the rear wheel.
2. Raise the front wheel off the ground by using a motorcycle stand.

To service the rear wheel

Raise the rear wheel off the ground by using a motorcycle stand or, if a motorcycle stand is not available, by placing a jack either under each side of the

PERIODIC MAINTENANCE AND ADJUSTMENT

Front wheel

EAU24360

To remove the front wheel

EAU49332

EWA10821

⚠ WARNING

To avoid injury, securely support the vehicle so there is no danger of it falling over.

1. Remove the rubber cap, and then loosen the front wheel axle pinch bolts and the axle nut.

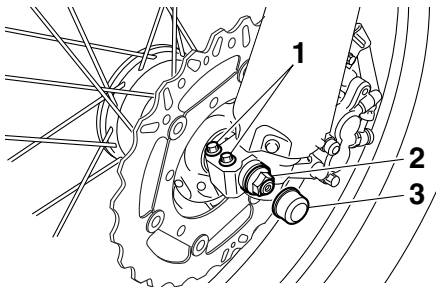

1. Front wheel axle pinch bolt
2. Axle nut
3. Rubber cap

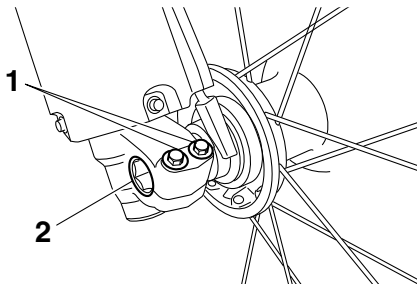

1. Front wheel axle pinch bolt
2. Wheel axle
2. Lift the front wheel off the ground according to the procedure in the previous section "Supporting the motorcycle".
3. Remove the axle nut.
4. Pull the wheel axle out.
5. Remove the spacers and the wheel. **NOTICE: Do not apply the brake after the wheel has been removed together with the brake disc, otherwise the brake pads will be forced shut.**^[ECA11071]

EAU49342

To install the front wheel

1. Install the spacers into both sides of the wheel hub. **NOTICE: When**

installing the spacers, be sure to install them on the correct side.^[ECA17700]

2. Lift the wheel up between the fork legs.

TIP

Make sure that there is enough space between the brake pads before installing the brake caliper onto the brake disc.

3. Insert the wheel axle from the right-hand side.
4. Install the axle nut.
5. Lower the front wheel so that it is on the ground, and then put the sidestand down.
6. Tighten the axle nut to the specified torque.

Tightening torque:

Axle nut:
90 Nm (9.0 m·kgf, 65 ft·lbf)

7. Tighten the front wheel axle pinch bolts to the specified torque, and then install the rubber cap.

PERIODIC MAINTENANCE AND ADJUSTMENT

Tightening torque:

Front wheel axle pinch bolt:
21 Nm (2.1 m·kgf, 15 ft·lbf)

8. Push down hard on the handlebar several times to check for proper fork operation.

Rear wheel

EAU25080

EAU45183

EWA10821

To remove the rear wheel



To avoid injury, securely support the vehicle so there is no danger of it falling over.

1. Loosen the axle nut.

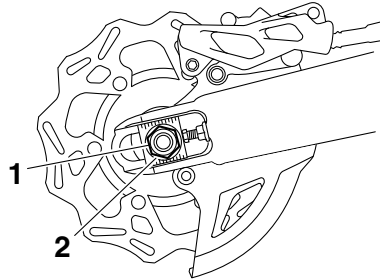

1. Axle nut
2. Washer

2. Lift the rear wheel off the ground according to the procedure on page 6-36.
3. Remove the axle nut and washer.
4. Loosen the locknut on each side of the swingarm.

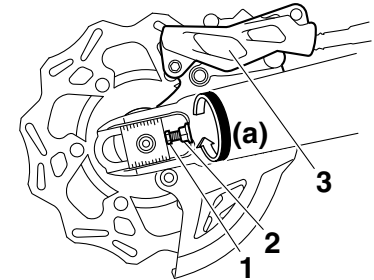

1. Drive chain slack adjusting bolt
2. Locknut
3. Brake caliper
5. Turn the drive chain slack adjusting bolts fully in direction (a).
6. Push the wheel forward, and then remove the drive chain from the rear sprocket.

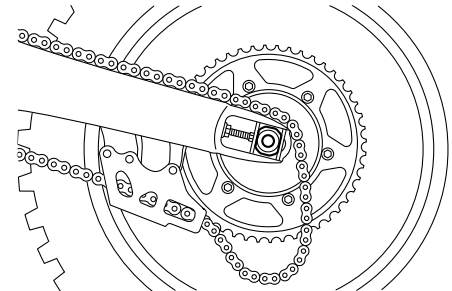

PERIODIC MAINTENANCE AND ADJUSTMENT

TIP

The drive chain does not need to be disassembled in order to remove and install the rear wheel.

7. While supporting the brake caliper, pull the wheel axle out.
8. Remove the drive chain pullers, spacers and the wheel. **NOTICE:** Do not apply the brake after the wheel has been removed together with the brake disc, otherwise the brake pads will be forced shut.^[ECA11071]

6

EAU45193

To install the rear wheel

1. Install the spacers into both sides of the wheel hub. **NOTICE:** When installing the spacers, be sure to install them on the correct side.^[ECA17700]
2. Install the wheel, drive chain pullers and the brake caliper bracket by inserting the wheel axle from the left-hand side.

TIP

- Make sure that the retainer on the brake caliper bracket is inserted

into the slot in the swingarm.

- Make sure that there is enough space between the brake pads before installing the wheel.

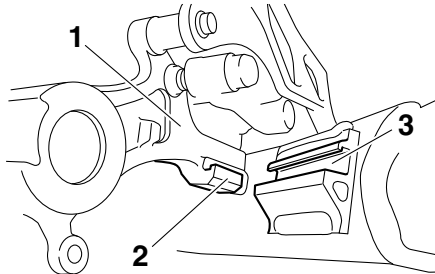

1. Brake caliper bracket

2. Retainer

3. Slot

3. Install the drive chain onto the rear sprocket.
4. Install the washer and the axle nut.
5. Lower the rear wheel so that it is on the ground, and then put the sidestand down.
6. Adjust the drive chain slack. (See page 6-25.)
7. Tighten the axle nut, and then the locknuts to their specified torques.

Tightening torques:

Axle nut:

125 Nm (12.5 m·kgf, 90 ft·lbf)

Locknut:

19 Nm (1.9 m·kgf, 14 ft·lbf)

EAU25871

Troubleshooting

Although Yamaha motorcycles receive a thorough inspection before shipment from the factory, trouble may occur during operation. Any problem in the fuel, compression, or ignition systems, for example, can cause poor starting and loss of power.

The following troubleshooting charts represent quick and easy procedures for checking these vital systems yourself. However, should your motorcycle require any repair, take it to a Yamaha dealer, whose skilled technicians have the necessary tools, experience, and know-how to service the motorcycle properly.

Use only genuine Yamaha replacement parts. Imitation parts may look like Yamaha parts, but they are often inferior, have a shorter service life and can lead to expensive repair bills.

EWA15141

WARNING

When checking the fuel system, do not smoke, and make sure there are no open flames or sparks in the area, including pilot lights from water

heaters or furnaces. Gasoline or gasoline vapors can ignite or explode, causing severe injury or property damage.

PERIODIC MAINTENANCE AND ADJUSTMENT

EAU53122

Troubleshooting charts

Starting problems or poor engine performance

1. Fuel

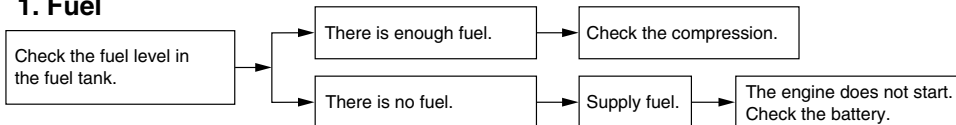

2. Battery

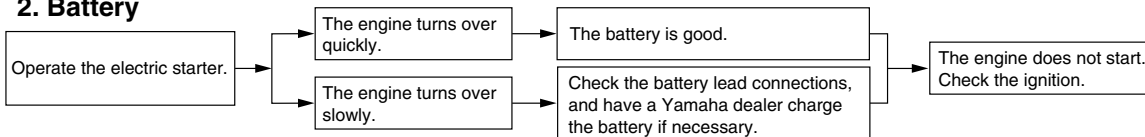

3. Ignition

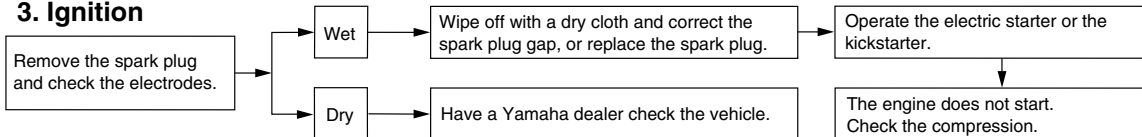

4. Compression

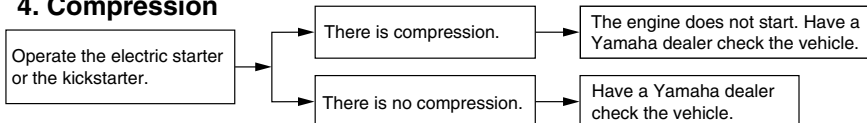

PERIODIC MAINTENANCE AND ADJUSTMENT

Engine overheating

EWAT1040

WARNING

- Do not remove the radiator cap when the engine and radiator are hot. Scalding hot fluid and steam may be blown out under pressure, which could cause serious injury. Be sure to wait until the engine has cooled.
- Place a thick rag, like a towel, over the radiator cap, and then slowly rotate the cap counterclockwise to the detent to allow any residual pressure to escape. When the hissing sound has stopped, press down on the cap while turning it counterclockwise, and then remove the cap.

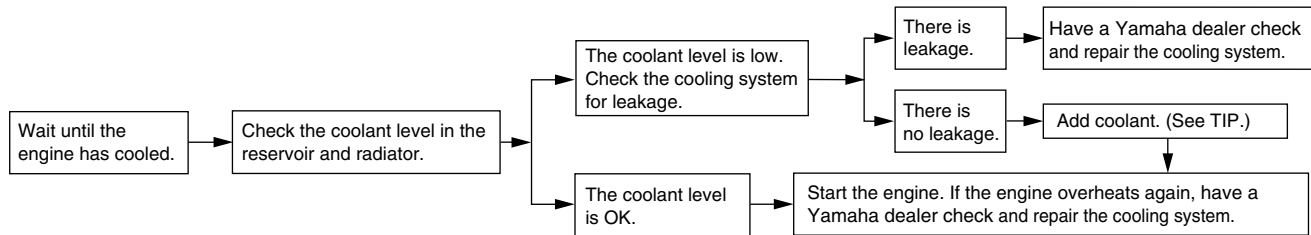

TIP

If coolant is not available, tap water can be temporarily used instead, provided that it is changed to the recommended coolant as soon as possible.

MOTORCYCLE CARE AND STORAGE

Matte color caution

EAU37833

EAU26004

NOTICE

Some models are equipped with matte colored finished parts. Be sure to consult a Yamaha dealer for advice on what products to use before cleaning the vehicle. Using a brush, harsh chemical products or cleaning compounds when cleaning these parts will scratch or damage their surface. Wax also should not be applied to any matte colored finished parts.

ECA15192

Care

While the open design of a motorcycle reveals the attractiveness of the technology, it also makes it more vulnerable. Rust and corrosion can develop even if high-quality components are used. A rusty exhaust pipe may go unnoticed on a car, however, it detracts from the overall appearance of a motorcycle. Frequent and proper care does not only comply with the terms of the warranty, but it will also keep your motorcycle looking good, extend its life and optimize its performance.

Before cleaning

1. Cover the muffler outlet with a plastic bag after the engine has cooled down.
2. Make sure that all caps and covers as well as all electrical couplers and connectors, including the spark plug cap, are tightly installed.
3. Remove extremely stubborn dirt, like oil burnt onto the crankcase, with a degreasing agent and a brush, but never apply such prod-

ucts onto seals, gaskets, sprockets, the drive chain and wheel axles. Always rinse the dirt and degreaser off with water.

Cleaning

ECA10772

NOTICE

- **Avoid using strong acidic wheel cleaners, especially on spoked wheels. If such products are used on hard-to-remove dirt, do not leave the cleaner on the affected area any longer than instructed. Also, thoroughly rinse the area off with water, immediately dry it, and then apply a corrosion protection spray.**
- **Improper cleaning can damage plastic parts (such as cowlings, panels, windshields, headlight lenses, meter lenses, etc.) and the mufflers. Use only a soft, clean cloth or sponge with water to clean plastic. However, if the plastic parts cannot be thoroughly cleaned with water, diluted mild detergent with water may be used. Be sure to rinse**

MOTORCYCLE CARE AND STORAGE

off any detergent residue using plenty of water, as it is harmful to plastic parts.

- Do not use any harsh chemical products on plastic parts. Be sure to avoid using cloths or sponges which have been in contact with strong or abrasive cleaning products, solvent or thinner, fuel (gasoline), rust removers or inhibitors, brake fluid, antifreeze or electrolyte.
- Do not use high-pressure washers or steam-jet cleaners since they cause water seepage and deterioration in the following areas: seals (of wheel and swing-arm bearings, fork and brakes), electric components (couplers, connectors, instruments, switches and lights), breather hoses and vents.
- For motorcycles equipped with a windshield: Do not use strong cleaners or hard sponges as they will cause dulling or scratching. Some cleaning compounds for plastic may leave scratches on the windshield.

Test the product on a small hidden part of the windshield to make sure that it does not leave any marks. If the windshield is scratched, use a quality plastic polishing compound after washing.

After normal use

Remove dirt with warm water, a mild detergent, and a soft, clean sponge, and then rinse thoroughly with clean water. Use a toothbrush or bottlebrush for hard-to-reach areas. Stubborn dirt and insects will come off more easily if the area is covered with a wet cloth for a few minutes before cleaning.

After riding in the rain, near the sea or on salt-sprayed roads

Since sea salt or salt sprayed on roads during winter are extremely corrosive in combination with water, carry out the following steps after each ride in the rain, near the sea or on salt-sprayed roads.

TIP

Salt sprayed on roads in the winter may

remain well into spring.

1. Clean the motorcycle with cold water and a mild detergent, after the engine has cooled down. **NOTICE: Do not use warm water since it increases the corrosive action of the salt.**^[ECA10791]
2. Apply a corrosion protection spray on all metal, including chrome- and nickel-plated, surfaces to prevent corrosion.

After cleaning

1. Dry the motorcycle with a chamois or an absorbing cloth.
2. Immediately dry the drive chain and lubricate it to prevent it from rusting.
3. Use a chrome polish to shine chrome, aluminum and stainless-steel parts, including the exhaust system. (Even the thermally induced discoloring of stainless-steel exhaust systems can be removed through polishing.)
4. To prevent corrosion, it is recommended to apply a corrosion protection spray on all metal,

MOTORCYCLE CARE AND STORAGE

EAU43202

including chrome- and nickel-plated, surfaces.

5. Use spray oil as a universal cleaner to remove any remaining dirt.
6. Touch up minor paint damage caused by stones, etc.
7. Wax all painted surfaces.
8. Let the motorcycle dry completely before storing or covering it.

EWA11131

WARNING

Contaminants on the brakes or tires can cause loss of control.

- **Make sure that there is no oil or wax on the brakes or tires.**
- **If necessary, clean the brake discs and brake linings with a regular brake disc cleaner or acetone, and wash the tires with warm water and a mild detergent. Before riding at higher speeds, test the motorcycle's braking performance and cornering behavior.**

ECA10800

NOTICE

- **Apply spray oil and wax sparingly and make sure to wipe off**

any excess.

- **Never apply oil or wax to any rubber and plastic parts, but treat them with a suitable care product.**
- **Avoid using abrasive polishing compounds as they will wear away the paint.**

TIP

- Consult a Yamaha dealer for advice on what products to use.
- Washing, rainy weather or humid climates can cause the headlight lens to fog. Turning the headlight on for a short period of time will help remove the moisture from the lens.

Storage

Short-term

Always store your motorcycle in a cool, dry place and, if necessary, protect it against dust with a porous cover. Be sure the engine and the exhaust system are cool before covering the motorcycle.

ECA10810

NOTICE

- **Storing the motorcycle in a poorly ventilated room or covering it with a tarp, while it is still wet, will allow water and humidity to seep in and cause rust.**
- **To prevent corrosion, avoid damp cellars, stables (because of the presence of ammonia) and areas where strong chemicals are stored.**

Long-term

Before storing your motorcycle for several months:

1. Follow all the instructions in the "Care" section of this chapter.
2. Fill up the fuel tank and add fuel

stabilizer (if available) to prevent the fuel tank from rusting and the fuel from deteriorating.

3. Perform the following steps to protect the cylinder, piston rings, etc. from corrosion.
 - a. Remove the spark plug cap and spark plug.
 - b. Pour a teaspoonful of engine oil into the spark plug bore.
 - c. Install the spark plug cap onto the spark plug, and then place the spark plug on the cylinder head so that the electrodes are grounded. (This will limit sparking during the next step.)
 - d. Turn the engine over several times with the starter. (This will coat the cylinder wall with oil.)
 - e. Remove the spark plug cap from the spark plug, and then install the spark plug and the spark plug cap. **WARNING! To prevent damage or injury from sparking, make sure to ground the spark plug electrodes while turning the engine over.**^[EWA10951]
4. Lubricate all control cables and the

pivoting points of all levers and pedals as well as of the sidestand/centerstand.

5. Check and, if necessary, correct the tire air pressure, and then lift the motorcycle so that both of its wheels are off the ground. Alternatively, turn the wheels a little every month in order to prevent the tires from becoming degraded in one spot.
6. Cover the muffler outlet with a plastic bag to prevent moisture from entering it.
7. Remove the battery and fully charge it. Store it in a cool, dry place and charge it once a month. Do not store the battery in an excessively cold or warm place [less than 0 °C (30 °F) or more than 30 °C (90 °F)]. For more information on storing the battery, see page 6-30.

TIP

Make any necessary repairs before storing the motorcycle.

SPECIFICATIONS

Dimensions:

- Overall length:
2315 mm (91.1 in)
- Overall width:
825 mm (32.5 in)
- Overall height:
1275 mm (50.2 in)
- Seat height:
960 mm (37.8 in)
- Wheelbase:
1475 mm (58.1 in)
- Ground clearance:
335 mm (13.19 in)
- Minimum turning radius:
2400 mm (94.5 in)

Weight:

- Curb weight:
129 kg (284 lb)
- Technical permissible mass (Maximum load +
Curb weight):
219 kg (483 lb)

Engine:

- Engine type:
Liquid cooled 4-stroke, DOHC
- Cylinder arrangement:
Single cylinder
- Displacement:
449 cm³
- Bore × stroke:
95.0 × 63.4 mm (3.74 × 2.50 in)
- Compression ratio:
12.30 : 1
- Starting system:
Electric starter and kickstarter

Lubrication system:

Dry sump

Engine oil:

- Recommended brand:
YAMALUBE
- Type:
SAE 10W-40, 10W-50, 15W-40, 20W-40 or
20W-50

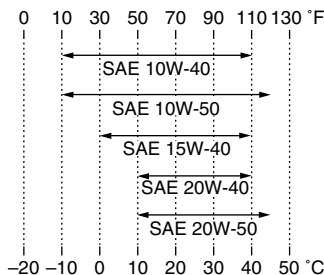

Recommended engine oil grade:

API service SG type or higher, JASO standard MA

Engine oil quantity:

- Without oil filter element replacement:
0.95 L (1.00 US qt, 0.84 Imp.qt)
- With oil filter element replacement:
1.00 L (1.06 US qt, 0.88 Imp.qt)

Cooling system:

- Radiator capacity (including all routes):
1.04 L (1.10 US qt, 0.92 Imp.qt)

Air filter:

- Air filter element:
Wet element

Fuel:

- Recommended fuel:
Premium unleaded gasoline only
- Fuel tank capacity:
7.2 L (1.90 US gal, 1.58 Imp.gal)
- Fuel reserve amount:
3.0 L (0.79 US gal, 0.66 Imp.gal)

Fuel injection:

- Throttle body:
ID mark:
1DX1 00

Spark plug(s):

- Manufacturer/model:
NGK/CR8E
- Spark plug gap:
0.7–0.8 mm (0.028–0.031 in)

Clutch:

- Clutch type:
Wet, multiple-disc

Transmission:

- Primary reduction ratio:
2.652 (61/23)
- Final drive:
Chain
- Secondary reduction ratio:
3.357 (47/14)
- Transmission type:
Constant mesh 5-speed
- Operation:
Left foot operation
- Gear ratio:
1st:
2.417 (29/12)

2nd:
1.733 (26/15)
3rd:
1.313 (21/16)
4th:
1.050 (21/20)
5th:
0.840 (21/25)

Chassis:

Frame type:
Semi double cradle
Caster angle:
27.00 °
Trail:
115 mm (4.5 in)

Front tire:

Type:
With tube
Size:
80/100-21M/C 51P
Manufacturer/model:
BRIDGESTONE/GRITTY-ED03 E

Rear tire:

Type:
With tube
Size:
120/90-18M/C 65P
Manufacturer/model:
BRIDGESTONE/GRITTY-ED04 E
Maximum load:
90 kg (198 lb)

* (Total weight of rider, cargo and accessories)

Tire air pressure (measured on cold tires):

Loading condition:
0–90 kg (0–198 lb)
Front:
150 kPa (1.50 kgf/cm², 22 psi)
Rear:
200 kPa (2.00 kgf/cm², 29 psi)

Front wheel:

Wheel type:
Spoke wheel
Rim size:
21x1.60

Rear wheel:

Wheel type:
Spoke wheel
Rim size:
18x2.15

Front brake:

Type:
Single disc brake
Operation:
Right hand operation
Specified brake fluid:
DOT 4

Rear brake:

Type:
Single disc brake
Operation:
Right foot operation
Specified brake fluid:
DOT 4

Front suspension:

Type:
Telescopic fork
Spring/shock absorber type:
Coil spring/oil damper
Wheel travel:
300.0 mm (11.81 in)

Rear suspension:

Type:
Swingarm (link suspension)
Spring/shock absorber type:
Coil spring/gas-oil damper
Wheel travel:
299.0 mm (11.77 in)

Electrical system:

Ignition system:
TCI
Charging system:
AC magneto

Battery:

Model:
YTZ7S(F)
Voltage, capacity:
12 V, 6.0 Ah

Headlight:

Bulb type:
Halogen bulb

Bulb voltage, wattage × quantity:

Headlight:
12 V, 35.0 W/35.0 W × 1
Tail/brake light:
LED
Front turn signal light:
12 V, 10.0 W × 2

SPECIFICATIONS

Rear turn signal light:

12 V, 10.0 W × 2

Auxiliary light:

12 V, 5.0 W × 1

License plate light:

12 V, 5.0 W × 1

Meter lighting:

EL (Electroluminescent)

Neutral indicator light:

12 V, 1.7 W × 1

High beam indicator light:

12 V, 1.7 W × 1

Turn signal indicator light:

12 V, 1.7 W × 1

Fuel level warning light:

LED

Engine trouble warning light:

12 V, 1.7 W × 1

Fuse:

Main fuse:

15.0 A

EAU48612

EAU26400

EAU26460

Identification numbers

Record the vehicle identification number and model label information in the spaces provided below for assistance when ordering spare parts from a Yamaha dealer or for reference in case the vehicle is stolen.

VEHICLE IDENTIFICATION
NUMBER:

MODEL LABEL INFORMATION:

Vehicle identification number

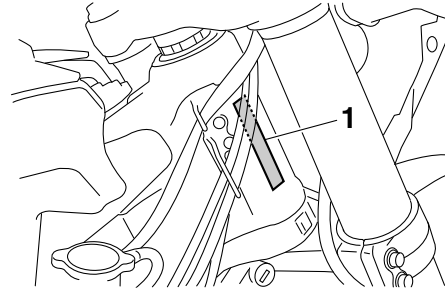

1. Vehicle identification number

The vehicle identification number is stamped into the steering head pipe. Record this number in the space provided.

TIP _____

The vehicle identification number is used to identify your motorcycle and may be used to register your motorcycle with the licensing authority in your area.

Model label

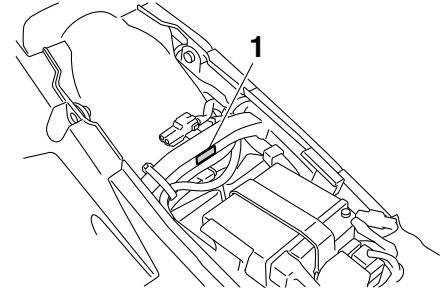

1. Model label

The model label is affixed to the location shown. Record the information on this label in the space provided. This information will be needed when ordering spare parts from a Yamaha dealer.

INDEX

A

- Air filter element and check hose, cleaning6-14
- Auxiliary light bulb, replacing6-35

B

- Battery6-30
- Brake and clutch levers, checking and lubricating6-27
- Brake fluid, changing6-24
- Brake fluid level, checking6-23
- Brake lever3-8
- Brake lever free play, checking6-21
- Brake light switches6-22
- Brake pedal3-9
- Brake pedal, checking and lubricating6-28

C

- Cables, checking and lubricating6-27
- Care7-1
- Catalytic converter3-11
- Clutch lever3-8
- Clutch lever free play, adjusting6-20
- Coolant6-12

D

- Dimmer switch3-7
- Drive chain, cleaning and lubricating6-26
- Drive chain slack6-25

E

- Engine break-in5-4
- Engine idling speed6-17
- Engine oil and oil filter element6-8
- Engine, starting a warm5-3
- Engine stop switch3-7
- Engine trouble warning light3-2

F

- Front and rear brake pads, checking6-23
- Front fork, adjusting3-14
- Front fork, bleeding3-15
- Front fork, checking6-29
- Fuel3-10
- Fuel consumption, tips for reducing5-4
- Fuel level warning light3-2
- Fuel tank breather hose3-11
- Fuel tank cap3-9
- Fuse, replacing6-32

H

- Handlebar switches3-7
- Headlight bulb, replacing6-32
- High beam indicator light3-2
- Horn switch3-7

I

- Identification numbers9-1
- Ignition circuit cut-off system3-19
- Indicator lights and warning lights3-1

K

- Kickstarter3-12

L

- License plate light bulb, replacing6-35

M

- Main switch3-1
- Maintenance and lubrication, periodic6-4
- Maintenance, emission control system6-3
- Matte color, caution7-1
- Model label9-1
- Multi-function display3-2

N

- Neutral indicator light3-1

P

- Panel, removing and installing6-7
- Parking5-5
- Part locations2-1

S

- Safety information1-1
- Seat3-13
- Shifting5-3
- Shift pedal3-8
- Shift pedal, checking6-22
- Shock absorber assembly, adjusting3-16
- Sidestand3-18
- Sidestand, checking and lubricating6-28
- Spark plug, checking6-7
- Specifications8-1
- Starter knob3-12
- Starting a cold engine5-1
- Start switch3-7
- Steering, checking6-30
- Steering lock3-13
- Storage7-3
- Supporting the motorcycle6-36
- Swingarm pivots, lubricating6-29

T

- Tail/brake light6-34
- Throttle grip and cable, checking and lubricating6-27
- Throttle grip free play, checking6-17
- Tires6-18
- Tool kit6-2
- Troubleshooting6-40
- Troubleshooting charts6-41
- Turn signal indicator light3-1
- Turn signal light bulb, replacing6-34

Turn signal switch.....3-7

V

Valve clearance6-18

Vehicle identification number.....9-1

W

Wheel bearings, checking6-30

Wheel (front).....6-37

Wheel (rear).....6-38

Wheels.....6-20

